

3048MS

Operating Manual
MODEL HP 3585B
Spectrum Analyzer

Serial Number
2824A00100 and greater



HP Part Number 03585-90004
Microfiche Part No. 03585-90204
Printed in U.S.A.

Print Date: March 1990

©Hewlett-Packard Company, 1978, 1988, 1990. All rights reserved.
8600 Soper Hill Road, Everett, WA 98205-1298

Warning



To prevent potential fire or shock hazard, do not expose equipment to rain or moisture.

X-RAY RADIATION NOTICE

ACHTUNG

Model 3585A/B

WARNING

Während des Betriebs erzeugt dieses Gerät Röntgenstrahlung. Das Gerät ist so abgeschirmt, daß die Dosisleistung weniger als 36 $\mu\text{A}/\text{kg}$ (0,5 mR/h) in 5cm Abstand von der Oberfläche der Katodenstrahlröhre beträgt. Somit sind die Sicherheitsbestimmungen verschiedener Länder, u.A. der deutschen Röntgenverordnung eingehalten.

Die Stärke der Röntgenstrahlung hängt im Wesentlichen von der Bauart der Katodenstrahlröhre ab, sowie von den Spannungen, welche an dieser anliegen. Um einen sicheren Betrieb zu gewährleisten, dürfen die Einstellungen der Niederspannung und des Hochspannungsnetzteils nur nach der Anleitung in Kapitel V des Handbuches vorgenommen werden.

Die Katodenstrahlröhre darf nur durch die gleiche Type ersetzt werden. (Siehe Kapitel VI für HP-Ersatzteile).

Das Gerät ist in Deutschland zugelassen unter der

Nummer 6.62-S104

When operating, this instrument emits x-rays; however, it is well shielded and meets safety and health requirements of various countries, such as the X-ray Radiation Act of Germany.

Radiation emitted by this instrument is less than 0.5 mR/hr at a distance of five (5) centimeters from the surface of the cathode-ray tube. The x-ray radiation primarily depends on the characteristics of the cathode-ray tube and its associated low-voltage and high voltage circuitry. To ensure safe operation of the instrument, adjust both the low-voltage and high-voltage power supplies as outlined in Section V of this manual (if applicable).

Replace the cathode-ray tube with an identical CRT only. Refer to Section VI for proper HP part number.

Number of German License: 6.62-S104



SAFETY SUMMARY

The following general safety precautions must be observed during all phases of operation, service, and repair of this instrument. Failure to comply with these precautions or with specific warnings elsewhere in this manual violates safety standards of design, manufacture, and intended use of the instrument. Hewlett-Packard Company assumes no liability for the customer's failure to comply with these requirements. This is a Safety Class 1 instrument.

GROUND THE INSTRUMENT

To minimize shock hazard, the instrument chassis and cabinet must be connected to an electrical ground. The instrument is equipped with a three-conductor ac power cable. The power cable must either be plugged into an approved three-contact electrical outlet or used with a three-contact to two-contact adapter with the grounding wire (green) firmly connected to an electrical ground (safety ground) at the power outlet. The power jack and mating plug of the power cable meet International Electrotechnical Commission (IEC) safety standards.

DO NOT OPERATE IN AN EXPLOSIVE ATMOSPHERE

Do not operate the instrument in the presence of flammable gases or fumes. Operation of any electrical instrument in such an environment constitutes a definite safety hazard.

KEEP AWAY FROM LIVE CIRCUITS

Operating personnel must not remove instrument covers. Component replacement and internal adjustments must be made by qualified maintenance personnel. Do not replace components with power cable connected. Under certain conditions, dangerous voltages may exist even with the power cable removed. To avoid injuries, always disconnect power and discharge circuits before touching them.

DO NOT SERVICE OR ADJUST ALONE

Do not attempt internal service or adjustment unless another person, capable of rendering first aid and resuscitation, is present.

USE CAUTION WHEN EXPOSING OR HANDLING THE CRT

Breakage of the Cathode-ray Tube (CRT) causes a high-velocity scattering of glass fragments (implosion). To prevent CRT implosion, avoid rough handling or jarring of the instrument. Handling of the CRT shall be done only by qualified maintenance personnel using approved safety mask and gloves.

DO NOT SUBSTITUTE PARTS OR MODIFY INSTRUMENT

Because of the danger of introducing additional hazards, do not install substitute parts or perform any unauthorized modification to the instrument. Return the instrument to a Hewlett-Packard Sales and Service Office for service and repair to ensure that safety features are maintained.

DANGEROUS PROCEDURE WARNINGS

Warnings, such as the example below, precede potentially dangerous procedures throughout this manual. Instructions contained in the warnings must be followed.

WARNING

Dangerous voltages, capable of causing death, are present in this instrument. Use extreme caution when handling, testing, and adjusting.

SAFETY SYMBOLS

General Definitions of Safety Symbols Used On Equipment or In Manuals.



Instruction manual symbol: the product will be marked with this symbol when it is necessary for the user to refer to the instruction manual in order to protect against damage to the instrument.



Indicates dangerous voltage (terminals fed from the interior by voltage exceeding 1000 volts must be so marked).

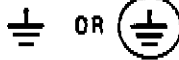

Protective conductor terminal. For protection against electrical shock in case of a fault. Used with field wiring terminals to indicate the terminal which must be connected to ground before operating equipment.



Low-noise or noiseless, clean ground (earth) terminal. Used for a signal common, as well as providing protection against electrical shock in case of a fault. A terminal marked with this symbol must be connected to ground in the manner described in the installation (operating) manual, and before operating the equipment.



Frame or chassis terminal. A connection to the frame (chassis) of the equipment which normally includes all exposed metal structures.



Alternating current (power line).



Direct current (power line).



Alternating or direct current (power line).

DANGER

The DANGER sign denotes a hazard. It calls attention to an operating procedure, practice, condition or the like, which could result in injury or death to personnel even during normal operation.

WARNING

The WARNING sign denotes a hazard. It calls attention to a procedure, practice, condition or the like, which, if not correctly performed or adhered to, could result in injury or death to personnel.

CAUTION

The CAUTION sign denotes a hazard. It calls attention to an operating procedure, practice, condition or the like, which, if not correctly performed or adhered to, could result in damage to or destruction of part or all of the product.

NOTE:

The NOTE sign denotes important information. It calls attention to procedure, practice, condition or the like, which is essential to highlight.

Table of Contents

SECTION I—General Information

Introduction	1-1
Specifications	1-1
Instrument and Manual Identification	1-1
Description	1-2
Options	1-3
Accessories Available	1-3

SECTION II—Installation and Interfacing

Introduction	2-1
Initial Inspection	2-1
Power Requirements	2-1
Power Cables	2-2
Grounding Requirements	2-2
Environmental Requirements	2-3
Operating Environment	2-3
Storage and Shipping Environment	2-3
Cooling System	2-3
Thermal Cutout	2-3
Installation	2-4
Mounting	2-4
Instrument Turn-On	2-6
HP-IB Connections and Interfacing	2-9
HP-IB Address Selection	2-10
HP-IB Descriptions	2-10
Repackaging for Shipment	2-10
Original Packaging	2-10
Other Packaging	2-10

SECTION III—Operating Instructions

Chapter 1—Overview and General Operating Information

Performance Summary and Description	3-1-2
Turn-On and Warm-Up	3-1-3
Operational Verification	3-1-4
The Power-Up Option	3-1-5
The Green Key	3-1-6
The Blue Key	3-1-7
Full Sweep	3-1-8
The Beeper	3-1-8
Input Functions	3-1-9
Display Adjustments/Trace Functions	3-1-12
Keyboard Entry Functions	3-1-13
Entry Keys	3-1-13
Step Keys	3-1-13
Number/Units Keyboard	3-1-13

Chapter 1 (con't)

Trace and Instrument State Storage	3-1-14
Bandwidth and Sweep Time Functions	3-1-16
Marker/Continuous Entry Functions	3-1-18
Marker/Manual Measurement Functions	3-1-19
Signal Tracking	3-1-20
Offset Function	3-1-20
Marker/Offset Entry Functions	3-1-21
Sweep and Trigger Functions	3-1-22
Limit Testing	3-1-23
Measurement Setup	3-1-24
Setting Limits	3-1-24
Turning Limit Testing On	3-1-27
Viewing Limits	3-1-28
Editing Limit Traces	3-1-29
Using a Measurement Trace as a Limit	3-1-30
Plotting	3-1-31
Set Up the Hardware	3-1-32
Set Up the Display	3-1-32
Options	3-1-33
Aborting the Plot	3-1-33
HP-IB Status Functions	3-1-34
Automatic Calibration	3-1-35
Rear-Panel Features	3-1-41

Chapter 2—Basic Operating Procedures

Six-Step Operating Procedure	3-2-1
1. Press Instrument Preset	3-2-1
2. Select Desired Input and Signal Source	3-2-3
3. Set Frequency Parameters	3-2-5
4. Set Resolution Bandwidth	3-2-11
5. Set Display Units and Reference Level	3-2-13
6. Measure Responses with Marker	3-2-17
Absolute Measurements	3-2-17
Relative Measurements	3-2-19
Special Measurement Techniques	3-2-22
Random Noise Spectral Density	3-2-22
Signal-to-Noise Ratio	3-2-23
Center-Frequency Stepping	3-2-24
Harmonic Distortion	3-2-24
Modulation Side Frequencies	3-2-26
Improving the Dynamic Range	3-2-29
Overdrive Reduces Noise	3-2-29
Underdrive Reduces Distortion	3-2-31
Measurements Using the Tracking Generator	3-2-34
General Measurement Procedures	3-2-37
Insertion Loss and Flatness Measurements	3-2-40

Table of Contents (con't)

Chapter 3—Operation in the Manual Mode

Introduction to the Manual Mode	3-3-1
Manual Key Functions	3-3-3
The Manual Measurement Point	3-3-4
Setting the Manual Frequency	3-3-5
The Marker	3-3-6
Independent Marker Tuning	3-3-8
Offset Measurements	3-3-9
Using the Counter in the Manual Mode	3-3-10
Marker at Manual Measurement Point	3-3-12
Marker Not at Manual Measurement Point	3-3-13
Offset Counter Measurements	3-3-13
Using the Noise Level Function	3-3-15
Noise Measurement Techniques	3-3-16
Stepping the Manual Frequency	3-3-17
Equally-Spaced Signals Over a Wide Span	3-3-17
Low-Level Harmonic Distortion	3-3-20
Stepping Manual Frequency by Stepping CF	3-3-23
Harmonic Distortion	3-3-23
IM Distortion Products	3-3-26

Chapter 4—Input and Range Functions

Inputs	3-4-2
Terminated Input	3-4-3
Overvoltage Protection	3-4-4
High Impedance Input	3-4-5
Overvoltage Protection	3-4-6
Probe Power Jack	3-4-6
Range	3-4-7
Range Readout	3-4-7
Settings for Terminated Input	3-4-8
Settings for High-Impedance Input	3-4-8
Auto Range Operation	3-4-9
Manual Ranging	3-4-9
Overload Indicator	3-4-10
Reference Level Tracking Function	3-4-11/3-4-12

Chapter 5—Operating Parameters and Entry Functions

The Major Parameters	3-5-1
Overview of Entry Methods	3-5-2
Parameter Definitions	3-5-3
Entry Keys	3-5-10
Parameter Readouts	3-5-12
Step Entries	3-5-14
Numeric Entries	3-5-15

Chapter 6—Display and Trace Functions

Introduction and Overview	3-6-1
The Graphic Presentation	3-6-6
Display Graticule	3-6-6
Horizontal Axis	3-6-7
Vertical Axis	3-6-8
Introduction to Digital Storage	3-6-9
The Digital Storage Concept	3-6-10
Frequency Resolution	3-6-11
Amplitude Resolution	3-6-12
Peak Detection	3-6-13
Peak Detection and Sweep Dynamics	3-6-14
Effects of Peak Detection and Time Interval	3-6-16
Trace Functions	3-6-19
Alphanumeric Readouts	3-6-25

Chapter 7—Bandwidth and Sweep Time Coupling

Overview	3-7-1
Introduction to Coupling	3-7-2
Operation with Optimized Coupling	3-7-3
Detailed Aspects of Operation	3-7-3
Bandwidth Coupling	3-7-4
Sweep Time Coupling	3-7-5

Chapter 8—Marker/Continuous Entry Functions

Overview	3-8-1
Detailed Aspects of Operation	3-8-3
Continuous Entry Functions	3-8-3
Marker Functions	3-8-9
Counter	3-8-10
Offset Functions	3-8-17
Noise Level	3-8-28
Signal Tracking	3-8-41
Peak Search	3-8-42

Chapter 9—Remote Operation

Introduction to HP-IB Operation	3-9-1
General HP-IB Description	3-9-1
Definition of HP-IB Terms and Concepts.	3-9-2
Basic Device Communication Capability.	3-9-3
Message Definitions.	3-9-3
Analyzer Response to Messages.	3-9-3
HP-IB Work Sheet.	3-9-3
HP-IB Addressing.	3-9-3
Setting the HP-IB Address	3-9-4
Analyzer HP-IB Capabilities.	3-9-6
Developing an HP-IB Program.	3-9-6
Universal and Addressed Commands.	3-9-8
Placing the Analyzer in Remote.	3-9-8

Table of Contents (con't)

Chapter 9 (con't)

Settling Time.	3-9-9
Bus Debugging	3-9-9
Analyzer Data Message Formats.	3-9-10
Compatibility with the 3585A	3-9-10
3585-Specific HP-IB Command Definitions	3-9-11
Introduction	3-9-11
Output Function Operating Conditions	3-9-11
Data Dump Modes	3-9-12
Dump Data Format	3-9-14
Trigger Modes.	3-9-20
Range Control.	3-9-21
Programming Marker Position.	3-9-21
Display Control.	3-9-22
Front-Panel Entry During Remote Operation.	3-9-26
Test Modes	3-9-28
Binary Data Mode.	3-9-29
Programming the A-B Trace Position	3-9-32
Status Byte	3-9-33
Control of SRQ for Status Bits 3 and 4.	3-9-33
Serial Poll.	3-9-34
Plotting via HP-IB.	3-9-34
Special Considerations For Remote Operation	3-9-35
Programing For Maximum Speed.	3-9-35/3-9-36
HP-IB Command Quick Reference	3-9-37

Appendix 3-A. Programming Examples

1. Simple Configuration Example	3-A-1
2. Same Configuration with Speed Optimized	3-A-1
3. Harmonic Distortion Using Manual Mode	3-A-2
4. Power Line Sidebands Using Manual Mode	3-A-3
5. Peak Search	3-A-4
6. Harmonic Levels and THD	3-A-5
7. Dumping Display to Raster-Graphics Printer	3-A-6
8. Setting an Arbitrary Offset	3-A-7
9. Dumping and Restoring Traces & States	3-A-8
10. Plotting Under Program Control	3-A-10
11. Limit Testing	3-A-10

Appendix 3-B. Meta Messages Block Diagrams

SECTION IV

Introduction	4-1
Operational Verification Tests Overview	4-1
Performance Test Card (description of use)	4-1
Calibration Cycle	4-1
Operational Verification	4-2
List of Tests	4-2
Performance Tests	4-3
Introduction	4-3
List of Tests	4-3
Recommended Test Equipment	4-4
Noise vs Bandwidth	4-6
Tracking Generator Frequency Accuracy	4-8
Residual Spurs	4-9
Low Frequency Responses	4-10
Zero Response	4-13
Tracking Generator Flatness	4-14
1 M Ω Input Noise	4-15
1 M Ω Input Check	4-16
1 M Ω Flatness	4-17
Bandwidth Accuracy	4-19
Image 90/10 MHz Spurs	4-21
IF Harmonic Distortion	4-22
Second-Order IF IM Distortion	4-24
Conversion/Input Spurs	4-26
Marker Accuracy	4-27
Cal Offset Test	4-28
Compression	4-30
API Spurs	4-33
Step IF Fractional-N Spurs	4-35
Local Oscillator Sidebands	4-37
Harmonic Distortion	4-40
Return Loss	4-44
IM Distortion (A)	4-47
IM Distortion (B)	4-49
Frequency Accuracy	4-52
Source Accuracy	4-54
50 Ω Flatness	4-56
Range Calibration	4-59
Amplitude Linearity	4-61
Reference Level Accuracy	4-62
Performance Test Card	

SECTION I

GENERAL INFORMATION

1-1. INTRODUCTION.

1-2. This Operating Manual contains information necessary to install, operate, and test the Hewlett-Packard Model 3585 Spectrum Analyzer.

1-3. This manual is divided into four sections, each covering a specific topic or aspect of the instrument:

Section	Topic
I	General Information
II	Installation and Interfacing
III	Front Panel and Remote Operation
IV	Performance Tests

1-4. This section of the manual contains the performance specifications and general operating characteristics of the 3585 . Also listed are available options and accessories, and instrument and manual identification information.

1-5. SPECIFICATIONS.

1-6. Operating specifications for the 3585 are listed in Table 1-1. These specifications are the performance standards or limits against which the instrument is tested. Any changes in specifications due to manufacturing, design or traceability to the U.S. National Bureau of Standards are included in Table 1-1 of this manual. Specifications listed in this manual supersede all previous specifications for the Model 3585 .

1-7. INSTRUMENT AND MANUAL IDENTIFICATION.

1-8 The instrument identification serial number is located on the rear panel. Hewlett-Packard uses a two-section serial number consisting of a four-digit prefix and a five-digit suffix separated by a letter designating the country in which the instrument was manufactured. (A = U.S.A.; G = West Germany; J = Japan; U = United Kingdom.) The prefix is the same for all identical instruments and changes only when a major instrument change is made. The suffix, however, is assigned sequentially and is unique to each instrument.

1-9. This manual applies to instruments with serial numbers indicated on the title page. If changes have been made in the instrument since this manual was printed, a yellow "Manual Changes" supplement supplied with the manual will define these changes and explain how to adapt the manual to the newer instruments. In addition, backdating information contained in Section VII adapts the manual to instruments with serial numbers lower than those listed on the title page.

1-10. On the title page of this manual following the Operating and Service Manual and Operating Information Supplement part numbers are Microfiche part numbers for these publications. These numbers can be used to order 4 x 6 inch microfilm transparencies of these publications. The Microfiche package includes the latest Manual Changes supplement and all pertinent Service Notes.

1-11. DESCRIPTION.

1-12. The 3585 is a 20 Hz to 40.1 MHz, microcomputer controlled spectrum analyzer. It may be utilized for spectrum analysis or network analysis (amplitude only) applications. As a spectrum analyzer, the 3585 provides a graphic display of the spectral components of the input signal. For network analysis measurements, the 3585 Tracking Generator can be used as a drive signal for the network under test. The network's output can then be applied to the 3585 input to obtain a graphic display of the network's amplitude versus frequency response.

1-13. The 3585 is structured as a conventional triple-conversion, swept super-heterodyne spectrum analyzer. The addition of microcomputer hardware control and data manipulation greatly enhances the analytical power of the 3585. Flexible control of the displayed trace is obtained through dedicated key subroutines that produce optimum displayed results in a minimum amount of time.

1-14. Microcomputer control gives the 3585 several unique features. The most obvious feature is the keyboard entry of parameters which replaces more conventional knobs. The input attenuation and mixer levels are automatically set by the 3585's Auto Range feature to maintain the specified dynamic range. Other microcomputer controlled features include: coupling of Frequency Span, Bandwidth and Sweep Time; centering of signals; moving signals to the Reference Level and storage and measurement of frequency and amplitude Offsets. Microcomputer control further allows the operator to over-ride the automatic features of the 3585.

1-15. The 3585's Local Oscillator is fully synthesized using -hp-'s patented Fractional N technique. This provides frequency settability of 0.1 Hz over the 20 Hz to 40.1 MHz range. Beyond the advantage of high system resolution, the 3585's Synthesized Local Oscillator allows stable, repeatable frequency measurements. The advanced design of the 3585's Fractional N synthesized Local Oscillator also results in phase-continuous, linear sweeps with low spurious sidebands.

1-16. The amplitude accuracy of the 3585 is enhanced by an Automatic Calibration system, through which internal analog offsets and errors are removed using the internal 10 MHz reference as a level and frequency standard and the Tracking Generator with an internal calibrator as a flatness standard. The calibration system measures and corrects errors caused by IF frequency and gain shifts, and input gain and flatness deviations. It also corrects the Tracking Generator frequency.

1-17. The trace information displayed on the 3585 CRT is digitally stored in memory. As a result, flicker-free, non-blooming displays are maintained independent of sweep time. Marker information and Entry parameters are displayed above and below the CRT graticule to give the operator the present instrument status. Prefaced parameters are intensified for easy data entry.

1-18. The 3585 keyboard controls are completely HP-IB programmable. In addition, commands are available to output information such as: active or stored keyboard settings; instrument status; A or B trace in marker amplitudes or normalized binary data; marker amplitude and frequency and CRT alphanumerics. A 50-character line of annotation or six 50-character lines of instructional messages can be displayed on the 3585 using the HP-IB. Finally, the keyboard may be configured as a limited data input terminal, with each key having a unique, numeric code. When coupled with the instructional message capability, this can provide a calculator based system where operator decisions can be entered on the 3585 keyboard. When used in this manner, the operator is not required to understand the calculator language, only answer the questions on the 3585 display.

1-19. OPTIONS.

1-20. The following options are available for use with the Model 3585:

Option No.	Description (see Figure 2-2)	Part Number
907	Front handle kit5062-3991
908	Rack mounting kit5062-3979
909	Front handle and rack mounting kit5062-3985
910	Additional Operating Manual	03585-90004
	and Service Manual	03585-90007

1-21. ACCESSORIES AVAILABLE.

1-22. The following is a list of accessories included with the 3585:

Item	Quantity	-hp- Part Number
Accessory Kit	1 each	03585-84401
Includes the following:		
Cable Assembly Extender	5 each	03585-61601
Cable Assembly Adapter	1 each	03585-61616
Jack to Jack Adapter	3 each	1250-0669
PC Extender Boards:		
43-pin	1 each	03585-66591
36-pin	1 each	03585-66590
18-pin	1 each	03585-66592
15-pin	1 each	03585-66595
15-pin	1 each	03585-66596
10-pin	1 each	03585-66593
6-pin	1 each	03585-66594

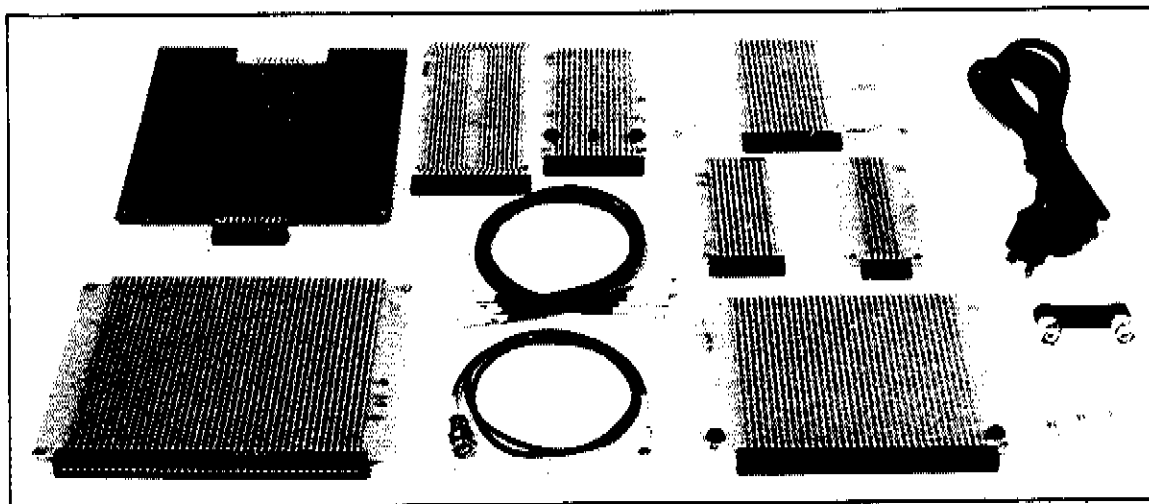

Figure 1-1. Accessory Kit

1-23. ACCESSORIES AVAILABLE (con't).

1-24. The following is a list of accessories available for use with the Model 3585.

a. Input Probes.

1. 1120A 1:1 active probe provides $100\text{ k}\Omega$ shunted by 3 pf.
2. 10021A 1:1 passive probe for $50\ \Omega$ or $1\text{ M}\Omega$ shunted by 70 pf.
3. 10040A 10:1 passive probe provides $1\text{ M}\Omega$ shunted by 9 pf.

b. Balancing Transformers.

1. 11473A $75\ \Omega$ to $600\ \Omega$ WECO 310.
2. 11473B $75\ \Omega$ to $600\ \Omega$ Siemens 9 REL STP-6AC.
3. 11474A $75\ \Omega$ WECO 241.
4. 11475A $75\ \Omega$ to $150\ \Omega$ Siemens 9 REL STP-6AC.
5. 11476A $75\ \Omega$ to $124\ \Omega$ WECO 408A.

c. Preamplifiers.

1. 461A 20 dB or 40 dB gain 1 kHz to 150 MHz.
2. 465A 20 dB or 40 dB gain 5 Hz to 1 MHz.

d. VHF Switch.

1. 59307A provides one pair of single throw 4-pole switches.

Specifications

Specifications describe the HP 3585B's warranted performance over the temperature range 0°C to 55°C except where noted. Supplemental characteristics are intended to provide information useful in applying the instrument by describing typical, but non-warranted performance. They are described as "typical" or "approximate" and apply over the temperature range $25 \pm 5^\circ\text{C}$.

Frequency

Measurement range: Specifications apply 20 Hz – 40.1 MHz

Start/stop, center, manual frequency: (selectable by keypad or fixed steps; center & manual frequencies also adjustable by knob and user-defined steps)

Range: 0 Hz – 40.1 MHz

Resolution: 0.1 Hz

Accuracy: Same as frequency ref. accuracy

Frequency span: (selectable by knob, keypad, or 1, 2, 5 step sequence)

Range: 0 Hz – 40.1 MHz

Resolution: 0.1 Hz

Frequency reference accuracy: $\pm 1 \times 10^{-7}$ /mo. of frequency. Warm-up time: 20 min.

Marker frequency:

Readout accuracy: $\pm 0.2\%$ of frequency span
 \pm resolution bandwidth

Counter accuracy: $\pm 0.3\text{Hz} \pm 1 \times 10^{-7}$ /mo. of counted frequency for a signal 20 dB greater than other signals and noise in the selected resolution bandwidth.

Resolution: 0.1 Hz

Resolution bandwidth:

Bandwidth: 3 Hz – 30 kHz (3 dB bandwidth) in 1, 3, 10 sequence. Bandwidth may be selected manually or automatically coupled to frequency span.

Accuracy: $\pm 20\%$ at 3 dB points

Selectivity: 60 dB/3 dB < 11:1

Video bandwidth: 1 Hz – 30 kHz in 1, 3, 10 sequence

Amplitude

Measurement range:

50/75Ω inputs: -137 dBm to +30 dBm or equivalent level in dBV or volts

1 MΩ input: 31 nVrms to 7.08 Vrms

Input range settings: Autoranging, -25 dBm to +30 dBm in 5 dB steps

AMPLITUDE ACCURACY:

Accuracy note: Measurement accuracy is determined by the sum of *reference level accuracy*, *amplitude linearity* (if the signal is not at the reference level) and *frequency response* across the measurement span (if the signal is not at the center or manual frequency). In measurements where the signal is at the reference level and/or at the center or manual frequency, the amplitude linearity and/or flatness uncertainties will not apply.

Reference level:

Range: -100 dB to +10 dB

(relative to input range)

Accuracy, 50/75Ω input: (using 1 or 2 dB/div., measured at manual frequency or with sweep rate reduced by a factor of 4)

+10 dB -50 dB -70 dB -90 dB

±0.4 dB ±0.7 dB ±1.5 dB

Typical accuracy, +10 dB to -50 dB: ± 0.25 dB

For 5 or 10 dB/div. add 0.1 dB to the figures above

For 1 MΩ input: Add to above specification

± 0.7 dB for 20 Hz – 10 MHz; ± 1.5 dB

for 10 MHz – 40.1 MHz

Amplitude linearity, 50/75Ω input:

(relative to reference level)

0 dB -20 dB -50 dB -80 dB -95 dB

±0.3 dB ±0.6 dB ±1.0 dB ±2.0 dB

Typical linearity, 0 dB to -20 dB: ± 2.0 dB

Frequency response, 50/75Ω input:

(relative to center frequency) ± 0.5 dB

Typical frequency response: ± 0.3 dB

For 1 MΩ input: Add to above specification

± 0.7 dB for 20 Hz – 10 MHz; ± 1.5 dB

for 10 MHz – 40.1 MHz

Amplitude (continued)

Marker amplitude:

Accuracy:

Center or manual frequency at the reference level:
Use reference level accuracy from +30 dBm to -115 dBm; add amplitude linearity below -115 dBm.
Anywhere on screen: Add amplitude linearity and frequency response. (Same as display accuracy)

Resolution:

10 dB/div. scaling: 0.1 dB
5 dB/div. scaling: 0.05 dB
2 dB/div. scaling: 0.02 dB
1 dB/div. scaling: 0.01 dB

Dynamic range

Spurious responses:

(image, out-of-band, and harmonic distortion)

50/75Ω input: < -80 dB relative to a single signal at or below the input range setting.

Typical performance: -84 dB - (1 dB/dB below input range setting)

Example: For a -8 dBm signal on the 0 dBm input range, the typical spurious responses would be -92 dB with a noise floor at -115 dBm (3 Hz).

1 MΩ input: < -80 dB except 2nd harmonic distortion < -70 dB

Intermodulation distortion:

50/75Ω input: < -80 dB relative to the larger of two signals, each ≥ 6 dB below input range setting except 2nd order IM from 10 MHz to 40 MHz < -70 dB

1 MΩ input: < -70 dB for 2nd order, < -80 dB for 3rd order

Residual responses (no signal at input): < -120 dBm using -25 dBm range, or 95 dB below input range setting

Residual phase noise (Typical at 40 MHz, -10 dBm input):

5 kHz offset: -112 dBc/Hz

100 kHz offset: -120 dBc/Hz

Average noise level:

50/75Ω input: (see Below)

1 MΩ input: Below 500 kHz add 12 dB to above

Average Noise Level

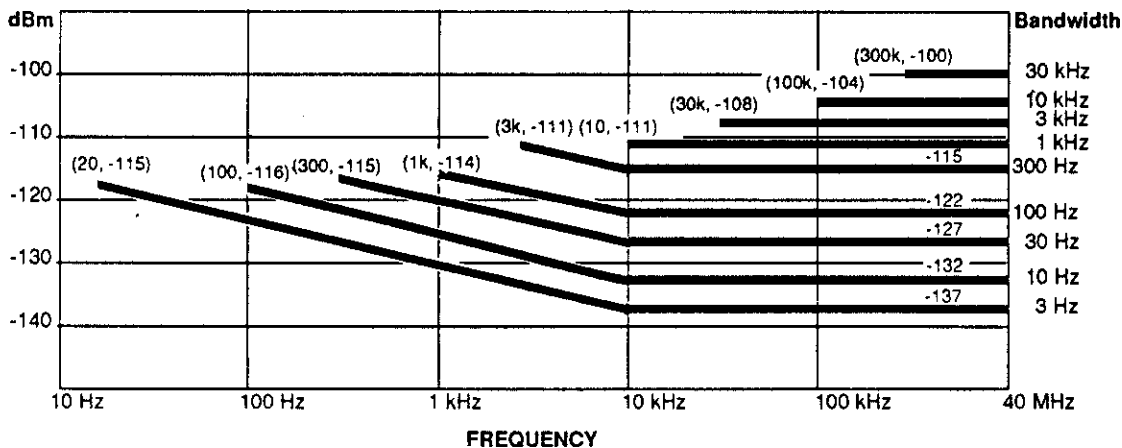

Display

Displayed amplitude range:

Scale: 10 vertical division graticule with reference level (0 dB) at top graticule line

Calibration: 1, 2, 5, 10 dB/division

Measurement traces: Two measurement traces can be displayed. Each trace is 1024 points vertical X 1001 points horizontal.

Trace A is updated by the analyzer sweep, recall from data registers, or by transfer from trace B.

Trace B is updated by transfer from trace A.

Trace functions: Transfer trace A to B, transfer trace B to A, max. hold, subtract trace B from A, clear trace A, save/recall trace A

Trace storage: 10 complete measurement traces can be stored in nonvolatile registers. These traces can be copied to the displayed traces A and B.

Limit testing: The measured trace is checked at the conclusion of each sweep for conformance to user-defined limits at every point. A pass/fail indication is provided in the display and over HP-IB.

Any two of the 10 nonvolatile trace registers can be used as limits. The two memories must be contiguous, with the lower numbered memory as the lower limit. Limits are entered as absolute or relative values. Limit lines can be displayed simultaneously with measurement traces.

Display hardcopy: Both display traces, including full annotation and limit lines, are automatically reproduced on HP-GL-compatible HP-IB pen-plotters and on graphics printers such as the HP Thinkjet and HP Laserjet.®

Trace detection: Linear envelope detection of video information from the IF signal. Peak signal excursions between sweep data points are measured and displayed to assure that no signal responses are missed.

Marker

Marker accuracy: See *Frequency and Amplitude* sections of these specifications

Marker search:

PEAK SEARCH -- Sets the marker to the highest signal in the displayed frequency span

NEXT PEAK -- Sets the marker to successively lower signal peaks in the displayed frequency span

NEXT LEFT -- Sets the marker to the next signal peak to the left of the current marker position in the displayed frequency span

NEXT RIGHT -- Sets the marker to the next signal peak to the right of the current marker position in the displayed frequency span

THRESHOLD -- When activated, the display line can be adjusted by the user as a search threshold

Functions:

FREQUENCY DISPLAY -- Absolute and relative (offset) modes

COUNTER -- Counted frequency of selected signal in absolute and relative (offset) modes

AMPLITUDE DISPLAY -- Absolute and relative (offset) modes

NOISE LEVEL -- Averaged and corrected noise level, normalized to 1 Hz bandwidth

SIGNAL TRACK -- Resets center frequency once per sweep to the peak signal found near the marker position.

Sweep

Modes: Continuous, single, manual (CW, direct or knob entry)

Trigger: Free run, external, line

Time: 0.2s to 200s/Hz of frequency span, excluding calibration cycles (autocalibration may be disabled)

Tracking generator

Level: 0 dBm to -11 dBm, manual control from front panel

Frequency accuracy: ± 1 Hz relative to analyzer tuning

Frequency response: ± 0.7 dB; Typically: ± 0.5 dB

Impedance: 50 Ω , >14 dB return loss

Signal inputs

50/75Ω: >26 dB return loss, BNC connectors

1 MΩ: ±3% shunted by <30 pF, BNC connector

Max. input level:

50/75Ω: 13V peak ac plus dc, relay protected for overloads to 42V peak.

1 MΩ: 42V peak ac plus dc (derated by factor of two for each octave above 5 MHz)

External trigger: Negative-going TTL level or contact closure initiates sweep

External frequency reference: 10 MHz or subharmonic to 1 MHz, 0 dBm minimum level

Signal outputs

Frequency reference: 10.00 MHz $\pm 1 \times 10^{-7}$ /mo., +10 dBm into 50Ω

IF: 350 kHz, -11 dBV to -15 dBV at the reference level

Video: 10 V at the reference level

External display: X, Y: 1V full deflection. Z: <0V to >2.4V

Probe power: +15 Vdc, -12.6 Vdc: 150 mA max., suitable for HP active probes

HP-IB interface

Complies with IEEE 488-1978

Control: All control settings except tracking generator level, CRT intensity, focus, astigmatism, graticule illumination

Interface functions: SH1 AH1 T5 L4 SR1 RL1 PP0 DC1 DT1 C0 E1

Instrument state storage

Setup state: 10 nonvolatile registers for storage of complete instrument configuration

Power-up state: HP 3585B can be configured to turn on in standard or user-defined state or in power-off state

General information

Environmental:

Temperature, operating: 0°C to 55°C

Humidity: < 95% RH

Warm up time: 20 min. at ambient room temperature

Power:

115V (+11% -25%), 48-440 Hz

230V (+11% -18%), 48-66 Hz

180 W, 3A max.

Weight: 36.7 kG (81 lb.)

Dimensions: 22.9 cm (9 in.)H X 42.6 cm (16.75 in.)W X 63.5 cm (25 in.) D

Ordering information:

HP 3585B spectrum analyzer

Option W30 2 years extended warranty

Option 907 Front handle kit

Option 908 Rack flange kit

Option 909 Combined rack flange/handle kit

Option 910 Additional set of manuals

SECTION II

INSTALLATION AND INTERFACING

2.1. INTRODUCTION.

2-2. This section contains instructions for installing and interfacing the Model 3585 Spectrum Analyzer. Included are initial inspection procedures, power and grounding requirements, environmental requirements, installation instructions, turn-on and interfacing procedures and instructions for repackaging for shipment.

2-3. INITIAL INSPECTION.

2-4. This instrument was carefully inspected both mechanically and electrically before shipment. It should be free of marks or scratches and in perfect electrical order upon receipt. To confirm this, carefully inspect the instrument for signs of physical damage incurred in transit, check for supplied accessories (Paragraph 1-21) and test the electrical performance using the Performance Test procedures given in Section IV. If there is physical damage, if the contents are incomplete or if the instrument does not pass the Performance Tests, notify the nearest -hp- Sales and Service Office. If the shipping container is damaged or the cushioning material shows signs of stress, notify the carrier as well as the Hewlett-Packard Office. Keep the shipping materials for the carrier's inspection.

WARNING

To avoid the possibility of dangerous electrical shock, do not apply ac line power to the 3585 if there are signs of shipping damage to any portion of the outer enclosure.

2-5. POWER REQUIREMENTS.

2-6. The Model 3585 requires a single-phase ac power source of:

86V to 127V, 48Hz to 440Hz (115V Voltage Selector Setting)

189V to 255V, 48Hz to 66Hz (230V Voltage Selector Setting)







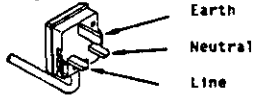
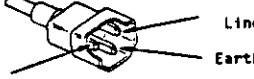

Maximum power consumption is less than 180 watts; maximum line current is 3 amperes. Refer to Paragraph 2-26 for the Instrument Turn On procedure.

CAUTION

Before applying ac line power to the 3585, be sure that the VOLTAGE SELECTOR switch is set for the proper line voltage and the correct line fuse is installed in the rear-panel line FUSE holder. (See Paragraph 2-26.)

2-7. Power Cables.

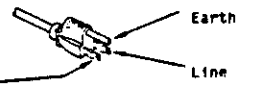
2-8. Figure 2-1 illustrates the standard power-plug configurations that are used for -hp- power cables. The -hp- part number directly below each drawing is the part number for a power cable equipped with a power plug of that configuration. The type of power cable that is shipped with each instrument is determined by the country of destination. If the appropriate power cable is not included with your instrument, contact the nearest -hp- Sales and Service Office and the proper cable will be provided.

<p>Option 900 BS 1363A Plug United Kingdom</p>  <p>Earth Neutral Line</p> <p>CABLE*: HP 5041-5807 220V - 5A OPERATION</p>	<p>Option 905 IEC 320-C14 For interconnecting system components and peripherals</p>  <p>Line Earth Neutral</p> <p>CABLE: 5041-5836 250V - 10A OPERATION</p>	<p>Option 917 Republic of South Africa and India</p>  <p>Earth Neutral Line</p> <p>CABLE: 5041-5822 250V - 10A OPERATION</p>	
<p>Option 901 NZSS 198/AS C112 Plug Australia/New Zealand</p>  <p>Earth Neutral Line</p> <p>CABLE*: 5041-5808 220V - 6A OPERATION</p>	<p>Option 906 SEV 1011.1959-24507 Type 12 Plug Switzerland</p>  <p>Neutral Earth Line</p> <p>CABLE*: 5041-5812 220V - 6A OPERATION</p>	<p>Option 918 MITI 41-9692 Plug Japan</p>  <p>Earth Neutral Line</p> <p>CABLE: 5041-5840 125V - 12A OPERATION</p>	
<p>Option 902 IEC 83 - C4 Continental Europe</p>  <p>Earth Line* Neutral* (* Line/Neutral Polarity Optional)</p> <p>PLUG*: CEE7-V11 220V - 6A CABLE*: 5041-5809 OPERATION</p>	<p>Option 912 DHCR 107 Plug Denmark</p>  <p>Line Earth Neutral</p> <p>CABLE*: 5041-5814 220V - 6A OPERATION</p>	<p>Option 903 U.S./Canada</p>  <p>Earth Neutral Line</p> <p>PLUG*: NEMA 5-15P 125V - 10A** CABLE*: 5041-5819 OPERATION</p>	
<p>*The number shown for the plug is the industry identifier for the plug only. The number shown for the cable is an HP part number for a complete cable including the plug. **UL Listed for use in the United States of America</p>			<p>Option 904 NEMA 6-15P Plug U.S./Canada</p>  <p>Line 1** Earth Line 2</p> <p>CABLE*: 5041-5806 250V - 6A** OPERATION</p>

WARNING

The power cable plug must be inserted into a socket outlet provided with a protective earth terminal. Defeating the protection of the grounded instrument cabinet can subject the operator to lethal voltages.

2-9. GROUNDING REQUIREMENTS.

2-10. To protect operating personnel, the instrument's panel and cabinet must be grounded. The Model 3585 is equipped with a three-wire power cord which, when plugged into an appropriate receptacle, grounds the instrument. The offset pin on the power plug is the ground connection.

2-11. ENVIRONMENTAL REQUIREMENTS.

WARNING

To prevent potential electrical or fire hazard, do not expose equipment to rain or moisture.

2-12. Operating Environment.

2-13. In order for the 3585 to meet the specifications listed in Table 1-1, the operating environment must be within the following limits:

- Temperature.....0°C to + 55°C(+ 32°F to + 131°F)
 - Relative Humidity..... ≤ 95%*
 - Altitude..... ≤ 15,000 feet
 - Magnetic Field Strength..... ≤ 0.1 gauss
- *Except 300Hz Res. BW, 40%

2-14. Storage and Shipping Environment.

2-15. The 3585 should be stored in a clean, dry environment. The following environmental limitations apply to both storage and shipment:

- Temperature..... - 40°C to + 75°C (- 40°F to + 158°F)
- Relative Humidity..... ≤ 95%
- Altitude..... ≤ 25,000 feet

In high-humidity environments, the instrument must be protected from temperature variations that could cause internal condensation.

2-16. Cooling System.

2-17. The 3585 uses a forced-air cooling system to maintain the proper internal operating temperature. The cooling fan is located on the rear panel. Air, drawn through the rear-panel fan filter, is circulated through the instrument and exhausted through holes in the side panels. The instrument should be mounted to permit as much air circulation as possible, with at least one inch of clearance at the rear and on each side. The filter for the cooling fan should be removed and cleaned at least once every 30 days. To clean the fan filter, simply flush it with soapy water, rinse and then air dry.

2-18. Thermal Cutout.

2-19. The 3585 is equipped with a thermal cutout switch which automatically disables the power supplies when the internal temperature exceeds + 65°C (external temperature approximately + 55°C). To reset the thermal cutout, set the LINE switch to OFF, allow time for the instrument to cool and then set the LINE switch to ON. (The thermal cutout will *not* reset automatically; the LINE switch must be turned off and then back on.) If a thermal cutout occurs, check for fan stoppage, clogged fan ports and other conditions that could obstruct air flow or cause excessive heating.

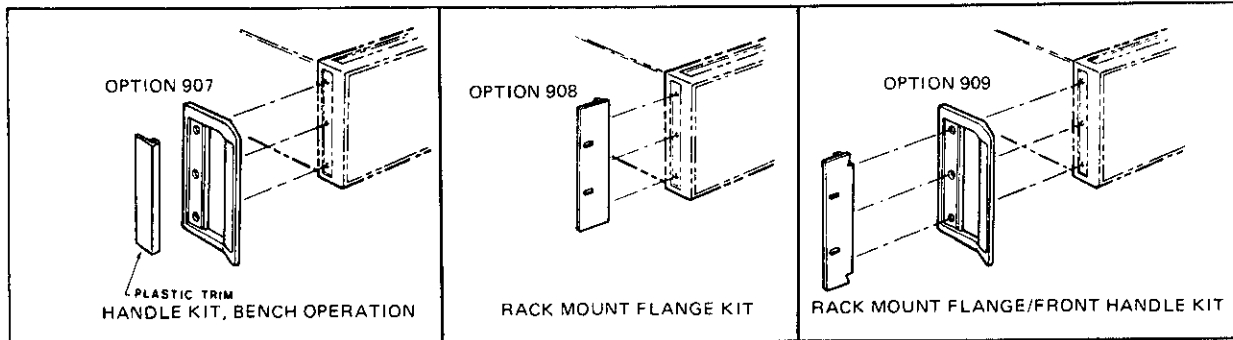

Figure 2-2. Rack Mount and Handle Kits.

2-20. INSTALLATION.

2-21. Mounting.

2-22. Bench Mounting. The 3585 is shipped with plastic feet attached to the bottom panel, ready for use as a bench instrument. The feet are shaped to make full-width modular instruments self align when they are staked. Because of its weight, the 3585 is not equipped with a tilt stand. It is recommended that a Front Handle Kit (Option 907, -hp- Part No. 5061-0091) be installed for ease of handling the instrument on the bench.

2-23. Rack Mounting. The 3585 can be rack mounted either with or without slides using the following procedures.

2-24. Rack Mounting Without Slides.

- a. Remove the plastic trim (Figure 2-2) and front handles from the 3585 if it is so equipped.
- b. Remove the plastic feet from the bottom of the 3585.
- c. Install the Rack Flange Kit with or without handles according to the instructions included in the kit:
 - Rack Flange Kit (no handles) Option 908, -hp- Part Number 5061-0079
 - Rack Flange & Front Handle Kit Option 909, -hp- Part Number 5061-0085
- d. Install an Instrument Support Rail on each side of the instrument rack. (The Instrument Support Rails, used to support the weight of the instrument, are included with -hp- rack-mount cabinets.)

WARNING

1. The weight of the 3585 must be supported by Instrument Support Rails inside the instrument rack. Do not under any circumstances attempt to rack mount the 3585 using only the front flanges.
 2. The 3585 is heavy for its size (approximately 88 lbs, 40 kg.). Use extreme care when lifting it to avoid personal injury.
- e. Using two people, lift the 3585 to its position in the rack on top of the Instrument Support Rails.
 - f. Using the appropriate screws, fasten the 3585's Rack-Mount Flanges to the front of the instrument rack.

2-25. Rack Mounting With Slides.

Following text replaces table and notes text on 2-5:

Qty.	Description	Part Number
1	Option 908, rack flange kit5062-3979
or	Option 909, rack flange and handle kit5062-3985
1	Heavy-duty slide kit1494-0016
2	Side covers5060-9948

NOTE

Instrument Support Rails are not absolutely necessary when rack mounting with slides. However, they do relieve a considerable amount of strain from the slides and provide an extra measure of safety.

- a. Perform Steps a through d of the previous procedure (Paragraph 2-24).

NOTE

Instrument Support Rails are not absolutely necessary when rack mounting with slides. However, they do relieve a considerable amount of strain from the slides and provide an extra measure of safety.

- b. Remove the 3585 side covers and replace them with the side covers listed at the beginning of this procedure.
- c. Attach a slide inner-member bracket to each side of the 3585
- d. Attach the slide's outer members to the instrument rack according to the instructions included with the slides.
- e. If your instrument rack has extension legs on the front, *be sure* that they are extended at this time.

WARNING

- 1. *When the 3585 is pulled out on fully-extended slide mounts, its weight can overturn an instrument rack. Physical injury can result. Care should be taken to avoid this situation.*
- 2. *The 3585 weighs approximately 88 pounds (40 kg.). Use extreme care when lifting it to avoid personal injury.*

- f. Using *two* people, lift the 3585 to its position in the rack and mate the two sections of the slides together. *Do not* rest the full weight of the 3585 on the extended slides until you are *sure* the instrument rack will not overturn.
- g. Slide the 3585 into the rack. Using the appropriate screws, fasten the 3585's Rack-Mount Flanges to the front of the rack.

2-26. Instrument Turn On.

a. Before connecting ac power to the 3585 :

1. Set the rear-panel VOLTAGE SELECTOR switch to the position that corresponds to the power-line voltage to be used:

Voltage Selector	Line Voltage
115V	86V to 127V (48-440Hz)
230V	189V to 255V (48-66Hz)

WARNING

To avoid serious injury, be sure that the ac power cord is disconnected before removing or installing the ac line fuse.

2. Verify that the proper line fuse is installed in the rear-panel FUSE holder:

Voltage Selector	Fuse Type	-hp- Part No.
115V	3A, 250V Normal Blo	2110-0003
230V	1.5A, 250V Normal Blo	2110-0043

WARNING

To protect operating personnel, the 3585 chassis and cabinet must be grounded. The 3585 is equipped with a three-wire power cord which, when plugged into an appropriate receptacle, grounds the instrument. The offset pin on the power plug is the ground connection. To preserve this protection feature, the power plug shall only be inserted in a three-terminal receptacle having a protective earth ground contact. The protective action must not be negated by the use of an extension cord or adapter that does not have the required earth ground connection. Grounding one conductor of a two-conductor outlet is not sufficient protection.

Ensure that all devices connected to the 3585 are also connected to the protective earth ground.

- b. Verify that the BNC-to-BNC jumper (supplied with the instrument) is connected between the rear-panel OVEN REF OUT and EXT REF IN connectors. (For information concerning the use of an external frequency reference, see Chapter 1 of Section III, Part One.)

c. Set the front-panel LINE switch to the OFF position.

- d. Connect the ac power cord to the rear-panel LINE connector. Plug the other end of the power cord into a three-terminal *grounded* power outlet.

- e. Set the front-panel INTENSITY control to the OFF (fully CCW) position.
- f. Set the LINE switch to the ON position.

NOTE

The instrument's beeper will sometimes sound as a result of the local oscillator initially being unlocked during the turn-on sequence. This initial "beep" may be ignored.

- g. Things to check:
 1. Verify that the cooling fan (located on the rear panel) is operating.
 2. Verify that the activated front-panel functions on your instrument correspond to those shown in Figure 2-3.
 3. Verify that the front-panel SWEEPING light is flashing.

If any of the above conditions is not met, turn the instrument off immediately and contact the nearest -hp- Sales and Service Office or a qualified service technician.

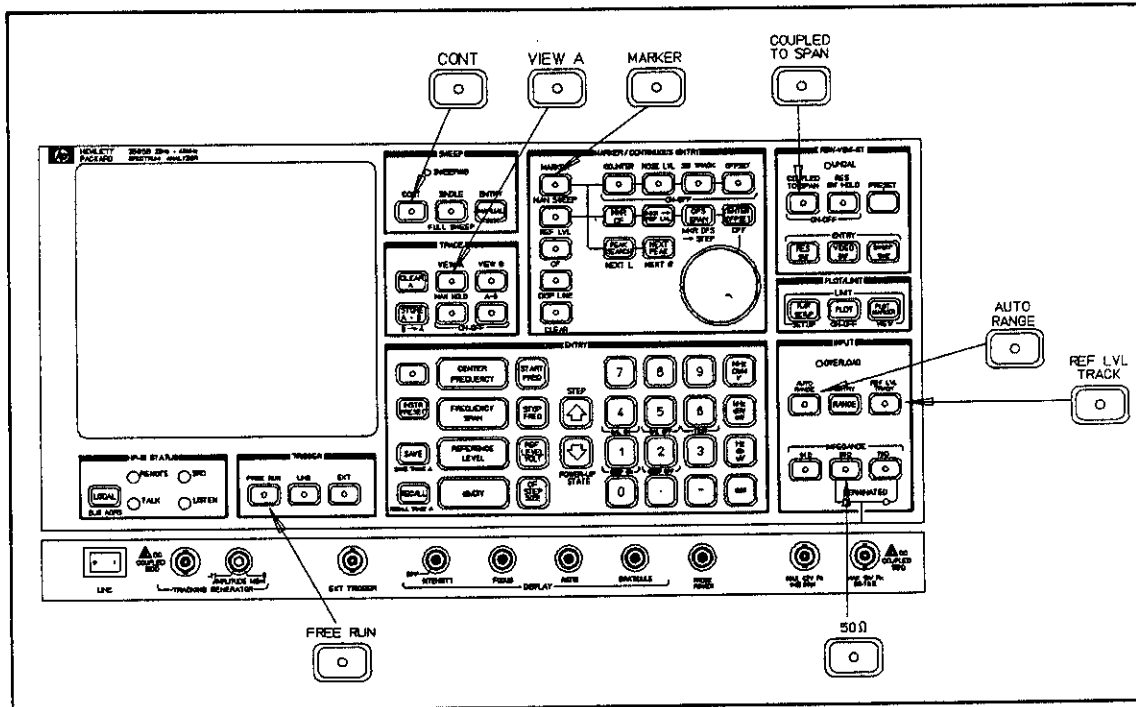

Figure 2-3. Front-Panel Functions Activated At Turn-On.

h. Adjust the front-panel INTENSITY control to obtain the desired intensity on the CRT screen. Adjust the FOCUS and ASTIG controls as follows:

1. Set the FOCUS control to midrange.
2. Adjust the ASTIG (Astigmatism) control for the sharpest trace possible.
3. Adjust the FOCUS control for the sharpest and clearest trace possible.
4. Repeat Steps 2 and 3 until optimum adjustment is obtained. If, after several iterations a sharp, clear presentation cannot be obtained, internal adjustments are probably required. These adjustments must be performed by a qualified service technician.

i. The CRT display should now appear as shown in Figure 2-4.

Verify that the Zero Response is present and is aligned with the first vertical line on the left-hand side of the CRT graticule.

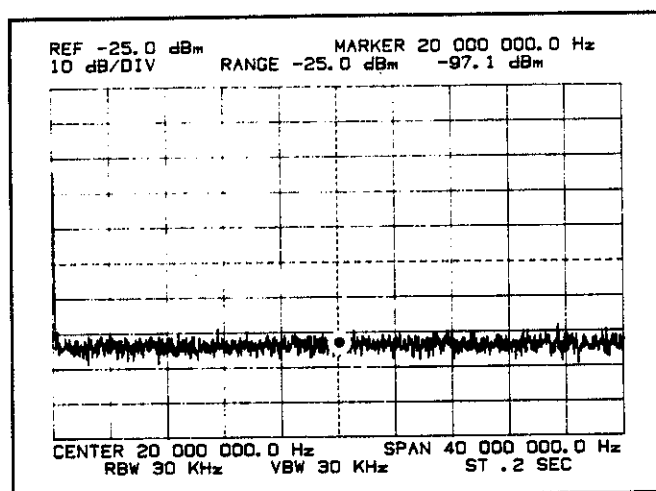



Figure 2-4. Turn-On Display.

j. Press the front-panel  key. (This will force an internal verification test and Automatic Calibration. The "CALIBRATING" message will appear on the CRT screen.)

If the beeper sounds and/or a Calibration Error Code (e.g., "CALIBRATION ERROR 03") appears on the CRT screen, the instrument is either defective or in need of adjustment. Turn the instrument off and contact -hp- or a qualified service technician.

k. The 3585's specifications are met after a 20-minute warmup at the ambient operating temperature.

NOTE

When the internal Oven Reference is enabled (about ten minutes after turn on), the beeper will sound and the "LOCAL OSC. UNLOCKED" message will momentarily appear on the CRT screen.

2-27. HP-IB Connections And Interfacing.*

2-28. The 3585 HP-IB connector (Figure 2-5) is compatible with the -hp- 10631 (A, B, C or D) HP-IB Cables. The 3585 uses all of the HP-IB lines. The HP-IB system allows you to interconnect up to fourteen HP-IB compatible instruments (including the controller). The HP-IB Cables have identical "piggyback" connectors on both ends so that several cables can be connected to a single source without special adapters or switch boxes. You can interconnect system components and devices in virtually any configuration you desire. There must, of course, be a path from the calculator (or other controller) to every device operating on the bus. As a practical matter, avoid stacking more than three or four cables on any one connector. If the stack gets too long, the force on the stack can produce sufficient leverage to damage the connector mounting. Be sure that each connector is firmly screwed in place to keep it from working loose (see CAUTION in Figure 2-5).

2-29. Cable Length Restrictions. To achieve design performance with the HP-IB, proper voltage levels and timing relationships must be maintained. If the system cables are too long, the lines cannot be driven properly and consequently, the system will fail to perform. When interconnecting an HP-IB system, observe the following rules:

- a. The total cable length for the system must be less than or equal to 20 meters (65 feet).
- b. The total cable length for the system must be less than or equal to 2 meters (6 feet) times the total number of devices connected to the bus.

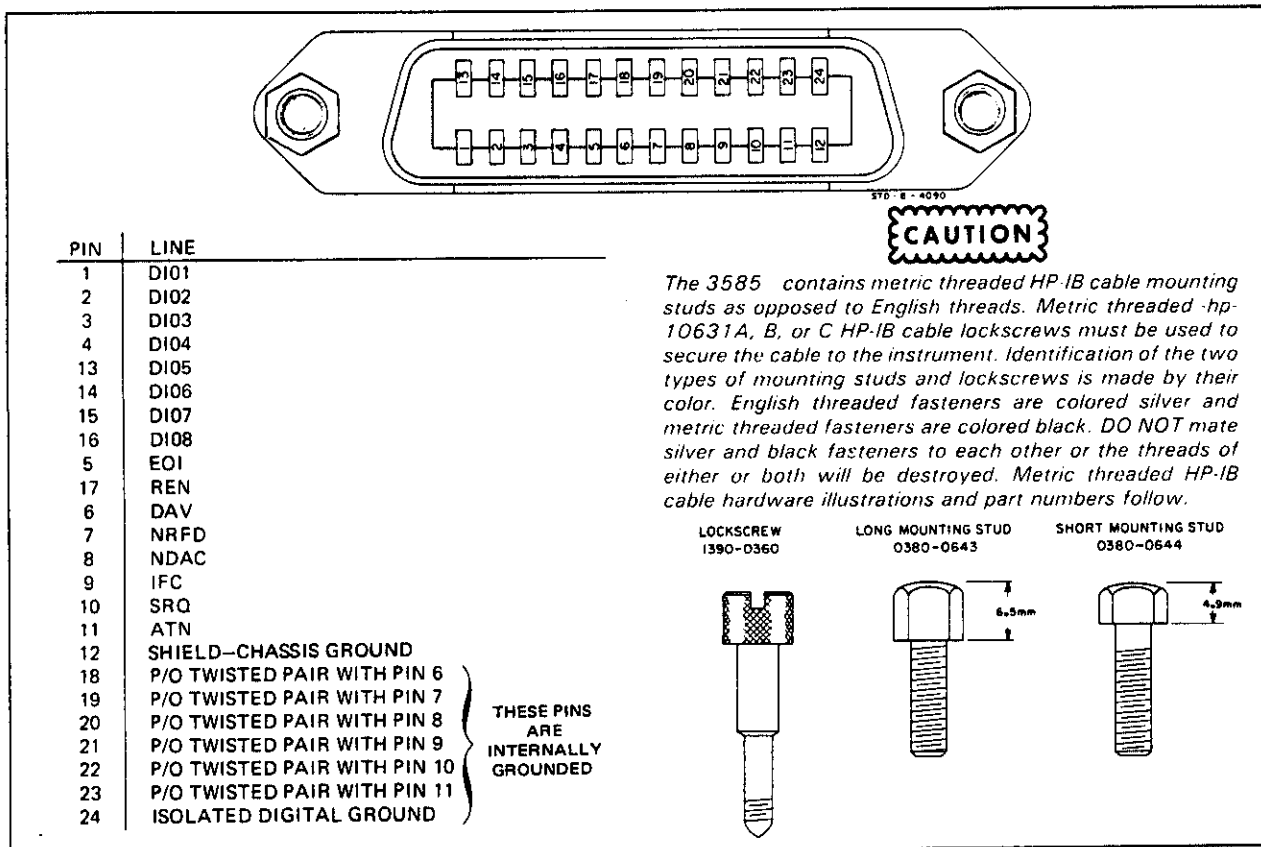

Figure 2-5. HP-IB Connector.

*Hewlett-Packard Interface Bus (HP-IB) is -hp-'s implementation of IEEE Standard 488-1975, "Digital Interface for Programmable Instrumentation".

2-30. Controller Interfacing. Instructions for interfacing the 3585 via the HP-IB are included in Section III, Chapter 9, "Remote Operation."

2-31. HP-IB Address Selection.

2-32. The 3585 is shipped from the factory with an HP-IB address of eleven. For information on changing this setting, see "Setting the HP-IB Address" in Section III, Chapter 9, "Remote Operation."

2-33. HP-IB Descriptions.

2-34. A description of the HP-IB is included in Section III, Chapter 9, "Remote Operation." A study of this information should be helpful if you are not familiar with the HP-IB concepts.

2-35. REPACKAGING FOR SHIPMENT.

2-36. Original Packaging.

2-37. If at all possible, repackage the instrument in the original container, which is specially designed to accommodate the weight of the 3585. Containers and materials equivalent to those used in factory packaging are available through -hp- Sales and Service Offices. Place the instrument in the container with appropriate (3 to 4 inches) packing material and seal well with strong tape or metal bands. Also mark the container "FRAGILE" to insure careful handling.

NOTE

If the instrument is to be returned to -hp- for service, attach a tag indicating the type of service required. Include any symptoms or details that may be of help to the service technician. Also include your return address, the instrument's model number and full serial number. In any correspondence, identify the instrument by model number and full serial number.

2-38. Other Packaging.

2-39. The following general instructions should be used for repackaging with commercially-available materials:

a. Wrap the instrument in heavy paper or plastic. (If shipping to a Hewlett-Packard office or service center, attach a tag indicating the type of service required, return address, model number, and full serial number.)

b. Use a strong shipping container. A doublewall carton made of 250-pound test material is adequate.

c. Use enough shock-absorbing material (3-to-4 inch layer) around all sides of the instrument to provide firm cushion and prevent movement inside the container. Protect the control panel with cardboard.

d. Seal the shipping container securely.

e. Mark the shipping container FRAGILE to assure careful handling.

SECTION III

OPERATING INSTRUCTIONS

This Section provides complete operating information for the HP 3585 Spectrum Analyzer. It is composed of nine chapters. The first eight chapters deal with front-panel operation, covering the basic and detailed aspects of operating the 3585 from the front panel.

Chapter 9 covers remote operation with a controller/computer via the Hewlett-Packard Interface Bus (HP-IB). This programming information is intended users thoroughly familiar with front-panel operation.

FRONT-PANEL OPERATION

PREFACE.

This first portion of Section III contains information and procedures to assist you in learning to operate the 3585 from the front panel. It is divided into eight chapters:

- Chapter 1. Overview And General Operating Information**
- Chapter 2. Basic Operating Procedures**
- Chapter 3. Operation In The Manual Mode**
- Chapter 4. Input And Range Functions**
- Chapter 5. Major Operating Parameters And Entry Functions**
- Chapter 6. CRT Display And Trace Functions**
- Chapter 7. Bandwidth And Sweep Time Coupling**
- Chapter 8. Marker/Continuous-Entry Functions**

This subsection has been made as comprehensive as possible in an effort to provide a useful and informative operational reference for the instrument, and is not intended to be read from cover-to-cover. The chapters are overlapping and, in some cases, deliberately redundant to allow you to read about a specific function and any related or interactive functions with a minimum of cross referencing. Most of the information that you will need to use the instrument is included in Chapters 1, 2 and 3.

After you have worked with the 3585 for awhile, you may have questions concerning some of its performance capabilities and operating features. While no printed manual can pretend to answer all questions or cover all situations, the answers to most of your questions can be found in Chapters 4 through 8, which cover some of the more subtle and detailed aspects of operation.

CHAPTER 1

OVERVIEW AND GENERAL OPERATING INFORMATION

This chapter provides an overview of the 3585 and general information concerning its major performance capabilities and operating features. Contents are as follows:

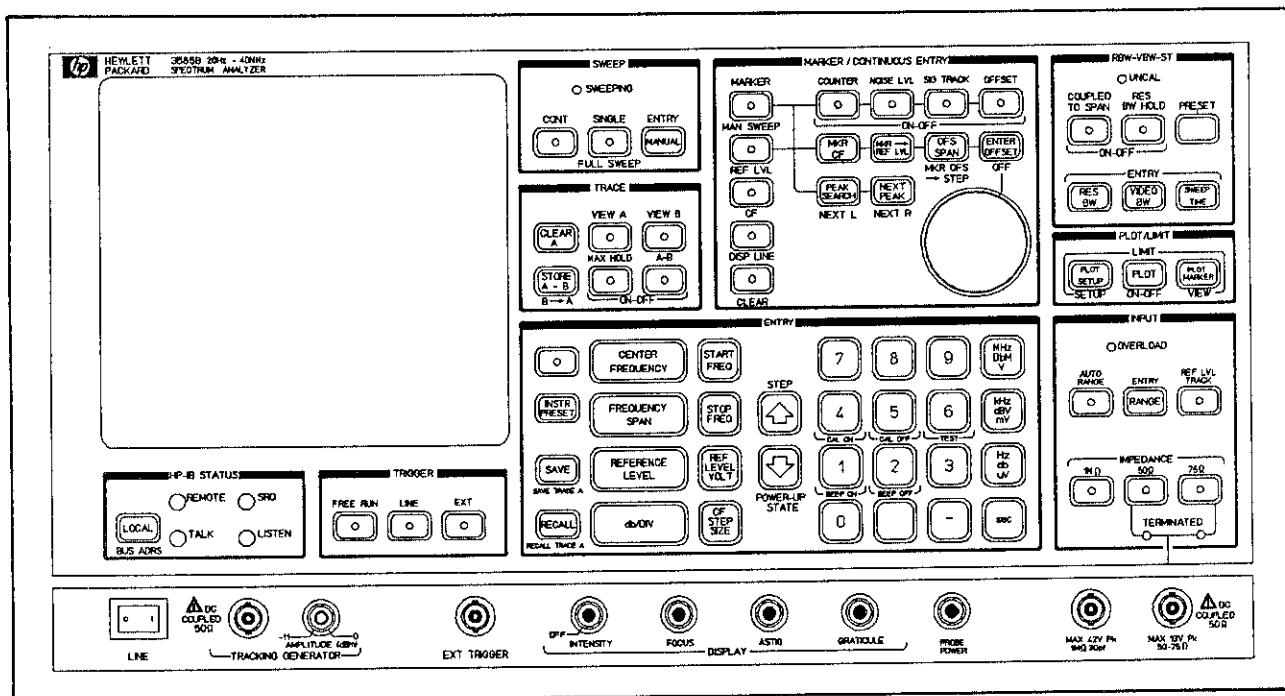

The 3585 Front Panel

PERFORMANCE SUMMARY/DESCRIPTION

PERFORMANCE SUMMARY AND DESCRIPTION

The Model 3585 is a high-performance, easy-to-use spectrum analyzer, covering the 20 Hz to 40.1 MHz frequency range. It can be used as a stand-alone bench instrument for signal-analysis and network-analysis applications; or, through its HP-IB interface, it can be linked to a computing controller and up to thirteen other HP-IB instruments to form a powerful automatic measurement system.*

3585 PERFORMANCE SUMMARY

FREQUENCY:

Measurement Range:

20 Hz to 40.1 MHz

Displayed Range:

0 Hz to 40.1 MHz full span

Resolution:

3 dB bandwidths of 3 Hz to 30 kHz in a 1, 3, 10 sequence

Accuracy

Manual Frequency:

$\pm 0.1 \text{ Hz} \pm 1 \times 10^{-7}/\text{mo.}$

Marker:

Normal $\pm 0.2\%$ of Frequency Span
 \pm Resolution Bandwidth

Counter $\pm 0.3 \text{ Hz} \pm 1 \times 10^{-7}/\text{mo.}$

AMPLITUDE:

Measurement Range:

-137 dBm to +30 dBm (50 Ω or 75 Ω)

Displayed Range:

10, 5, 2, 1 dB/DIV over a 10 division scale

Dynamic Range:

Harmonic distortion and third order intermodulation distortion $> 80 \text{ dB}$ below signal \leq to the Range Setting..

Average Noise Level:

$< -137 \text{ dBm}$ in the 3 Hz Resolution Bandwidth

Accuracy:

Best achievable accuracy over the measurement range is $\pm 0.4 \text{ dB}$ to $\pm 1.3 \text{ dB}$ depending on the level.

SWEEP:

Time:

0.2 sec. to 59,652 hrs.

INPUT:

Signal Inputs:

Terminated 50/75 Ω ; return loss $> 26 \text{ dB}$

High-Impedance 1 M Ω ; $\pm 3\%$ shunted by $< 30 \text{ pf}$

Max. Input Level:

50/75 Ω ; +30 dBm (1 watt)

1 M Ω ; 42 V Peak

OUTPUTS:

Tracking Generator:

0 dBm to -11 dBm (50 ohms)

Display:

X, Y, and Z outputs for auxiliary CRT display

INSTRUMENT STATE AND TRACE MEMORY STORAGE:

As many as ten user-defined instrument states may be saved in nonvolatile memory and recalled for later use.

As many as ten traces may be stored in nonvolatile memory and recalled for later use.

REMOTE OPERATION:

All analyzer control settings (with the exception of line, tracking generator amplitude and display) can be programmed via the Hewlett-Packard Interface Bus (HP-IB).*

*Hewlett-Packard Interface Bus (HP-IB) is -hp-'s implementation of IEEE Standard 488-1975 and identical ANSI Standard MC1.1, "Digital Interface for Programmable Instrumentation". HP-IB operation is described in Section III, Part 2.

TURN ON AND WARMUP

Before applying ac line power to the 3585 , make certain that the rear-panel VOLTAGE SELECTOR switch is in the position that corresponds to the voltage and frequency of the ac power source. Also verify that the proper line fuse is installed in the rear-panel fuse holder (see Section II).

The 3585 specifications are met after a 20-minute warmup at the ambient operating temperature.

Frequency Reference

The 3585 can be operated using its own internal Oven Reference or an external frequency reference. The internal or external frequency reference must be connected to the rear-panel EXT REF IN connector.

Internal Oven Reference

The 3585 is equipped with a temperature-stabilized, crystal-controlled 10 MHz reference oscillator, whose output is available at the rear-panel OVEN REF OUT connector. The frequency accuracy of this internal Oven Reference is expressed as a time coefficient of $10 \text{ MHz} \pm 1 \times 10^{-7}$ per month, relative to the time the instrument is shipped from the factory or the reference frequency is adjusted using the procedure outlined in the 3585 Service Manual. The Oven Reference time coefficient is included in the Counter and Manual frequency accuracy specifications.

To use the internal Oven Reference, connect the BNC to BNC jumper (supplied with the instrument) between the rear-panel OVEN REF OUT and EXTERNAL REF IN connectors.

NOTES

- 1. Power is applied to the internal reference oven only when the LINE switch is in the ON position. The 3585 does not have a "standby" mode.*
- 2. The output of the internal Oven Reference is disabled until the oven reaches the proper operating temperature. During the oven warmup cycle, there is no signal applied to the EXT REF IN connector; so the 3585's master oscillator runs in the open-loop mode in which the frequency accuracy is unspecified. When the oven reaches the proper operating temperature (about ten minutes after turn on), the Oven Reference is automatically enabled. At that time, the beeper sounds and the message, "L.O. UNLOCKED" momentarily appears on the CRT screen. The message disappears as soon as the master oscillator is phase-locked to the Oven Reference.*

TURN ON AND WARMUP

External Reference

For applications requiring optimum frequency accuracy, the 3585 can be phase locked to an external frequency standard. The external reference frequency must be 10 MHz or any subharmonic down to 1 MHz (± 5 ppm); and the amplitude must be within the range of 0 dBm to +15 dBm (50 ohms). The frequency accuracy of the external reference may be substituted for the Oven Reference time coefficient in the Counter and Manual frequency-accuracy specifications. To avoid performance degradation, the phase noise and spurious content of the external reference signal must be at least -110 dBc (1 Hz) relative to 10 MHz at a 20 Hz to 1 kHz offset.

To use an external reference:

1. Remove the jumper from between the rear-panel OVEN REF OUT and EXTERNAL REF IN connectors.

(To keep from losing the jumper, you may connect one end of it to any unused rear-panel connector.)

2. Using a shielded cable equipped with BNC connectors, connect your external reference to the EXTERNAL REF IN connector.

(When the reference is initially connected, the beeper will sound and the "L.O. UNLOCKED" message will appear on the screen. The message will continue to be displayed until the master oscillator is properly phase-locked to the external reference.)

Operational Verification

The 3585 automatically performs an internal operational verification test and calibration during its turn-on sequence and also when the  key is pressed. This internal test verifies that most of the analog and digital circuitry is operating properly; but it does not verify that the 3585 meets its published specifications. In the event of a test failure, the instrument's beeper will sound and, in most cases, a Calibration Error Code or failure message will appear on the CRT screen.

NOTE

The beeper will sometimes sound as a result of the local oscillator being unlocked during the instrument's turn-on sequence; but this initial "beep" does not constitute a test failure. To perform the verification test, allow the instrument to warmup for about two minutes and then press . If this causes the beeper to sound, the instrument is either defective or in need of adjustment. Contact a qualified service technician or return the 3585 to -hp- for service.

THE POWER-UP OPTION

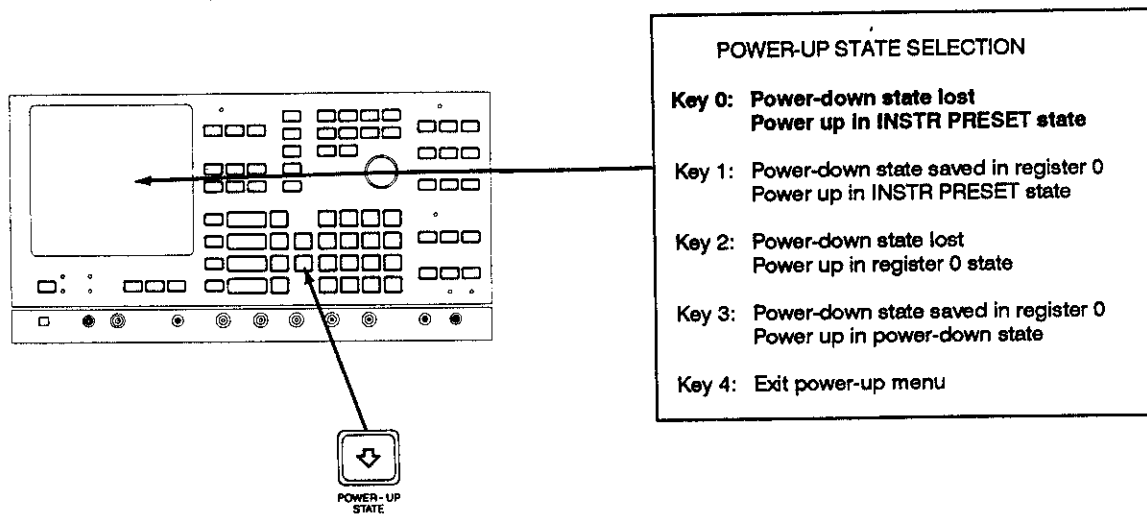

There are four possible actions the analyzer can take when the power is turned on. To make this selection, first, display the Power-Up State Selection menu by pressing (blue) Power-Up State key (down arrow key). Pressing a numeric key selects the action the analyzer takes when the power is cycled (see figure).

- Pressing the "0" key causes the analyzer to power-on in the Instrument Preset state. No other actions are taken.
- Pressing the "1" key causes the analyzer to save its last state in register 0 when the power is cycled. This save is not performed if there have been no bus or front-panel commands since the power was last turned off. The analyzer powers on in the Instrument Preset state.
- Pressing the "2" key causes the analyzer to power-on in the state in register 0. Register 0 is not altered.
- Pressing the "3" key causes the analyzer to save its last state in register 0 when the power is turned off. This state is then recalled shortly after the power is again restored.

NOTES

1. In options 2 and 3, the recall of register 0 does not occur until after the sweep has been started in the Instrument Preset state. Thus, until a complete sweep has completed, there is some incorrect data at the beginning of the sweep.
2. If, in options 2 and 3, the analyzer detects bad data in register 0, it reverts to the Instrument Preset state and displays an error message.
3. The power-up option is not changed by Instrument Preset.

FRONT-PANEL TOUR

THE GREEN KEY

THE GREEN KEY

The Instrument Preset key is the green key in the Entry front-panel section. The primary purpose of this key is to provide a convenient starting place for a measurement setup. The same thing may be accomplished for other setup states by saving and recalling states in one of the ten instrument state registers (see "Instrument State Storage" in Chapter 1). Pressing the Instrument Preset key changes the instrument parameters and functions to values and settings which, collectively, are called the "Instrument Preset State" (see figures below). (The definition of the turn-on state is dependent on the power-up option selected.) Instrument Preset does not erase trace memory and it does not erase the instrument state registers. Specifically, it performs the following functions:

- Restores a full 0 Hz-to-40 MHz frequency span with resolution and video bandwidths of 30 kHz and a 0.2 second sweep time, continuous sweep active.
- Optimizes the reference level coupling and bandwidth/sweep-time coupling.
- Activates the terminated input and selects the 50Ω impedance setting.
- Initiates an internal test sequence and an automatic calibration.

Memory Clear

Memory-clear is a special Preset operation that clears all registers and memory in the analyzer. This is provided as a convenience to quickly clear all information from the analyzer and as a fail-safe trouble-shooting tool to use in the case where bad stored data (e.g.; in the power-up instrument state register) is preventing the analyzer from operating. To perform a memory-clear:

1. Turn the power switch off.
2. Press and continue to hold the green Instrument Preset key.
3. Turn the power on. Continue holding the Preset key until the front-panel lights quit blinking.

Instrument Preset State Parameter Values	
Range	+30.0 dBm*
Reference Level	+30.0 dBm
Vertical Scale (dB/DIV)	10.0 dB/div
Frequency Span	40.0 MHz
Center Frequency	20.0 MHz
Start Frequency	0.0 Hz
Stop Frequency	40.0 MHz
Resolution Bandwidth	30.0 kHz
Video Bandwidth	30.0 kHz
Sweep Time (ST)	0.2 s
Marker Frequency	20.0 MHz
Offset Amplitude	0.0 dBV
Offset Frequency	0.0 Hz

* With no input, the analyzer automatically downranges to -25 dBm. With Reference Level Tracking activated, the Reference Level changes when the Range setting changes.

Functions Activated by Instrument Preset

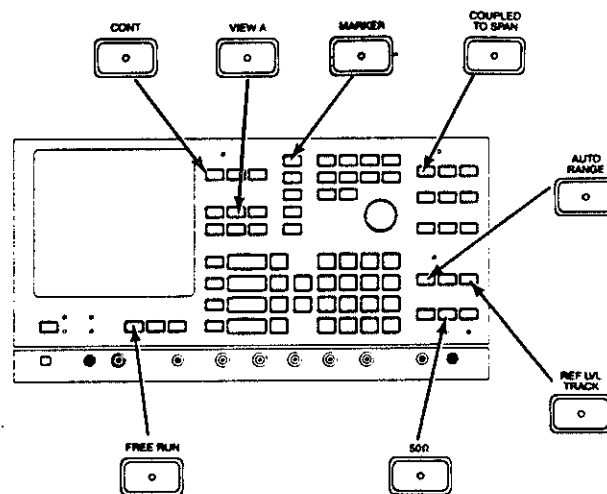

THE BLUE KEY

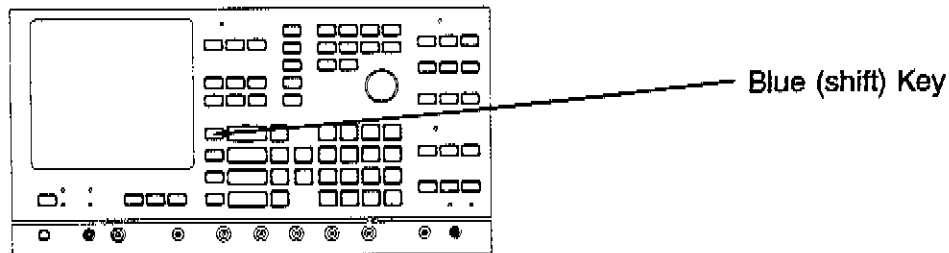

Many of the front-panel keys may be used to activate two functions. These are identified by the blue lettering below the key. The name of the first or primary function served by the key is printed on or above it. The blue text is the function name of the second function served by the key. These are sometimes referred to as "shifted functions" because you must first press the blue shift key before pressing the function key. Each of these functions is documented later in this operating manual.

Pressing the blue key turns on a light in the center of the key to indicate that the shift is active and that the secondary function of any double function key will be activated when it is pressed. If the key pressed after the blue key has no blue text under it (and no secondary function), nothing happens when it is pressed except that the light in the blue key goes out. If the blue key is pressed repeatedly, the light and the shift status toggle on and off.

Some shifted function names do not appear on the front panel (semicolon separates key presses from description in the following list).

- (blue) . ; (decimal point in numeric keypad) toggles the displayed grid on and off.
- (blue) Free Run; (in the Trigger section) displays the ROM version code in the lower-left corner.
- (blue) Line; (Trigger section) toggles annotation line on and off (see "Display Control" in Ch. 9).
- (blue) External; (Trigger section) toggles script lines on and off (see "Display Control" in Ch. 9).
- (blue) Offset; (Marker section) toggles tracking generator offset mode (see "Test Modes" in Ch. 9).
- (blue) Res BW; (RBW-VBW-ST section) toggles single loop mode (see "Test Modes" in Ch. 9).
- (blue) A-B; (Trace section) if the display line is set, changes the A-B reference to the position of the display line (see "Programming the A-B Trace Position" in Ch. 9).
- (blue) 3; (Numeric keypad) toggles bus debugging on and off. Effective only in remote control. (see "Bus Debugging" in Ch. 9.)

FRONT-PANEL TOUR

THE BEEPER

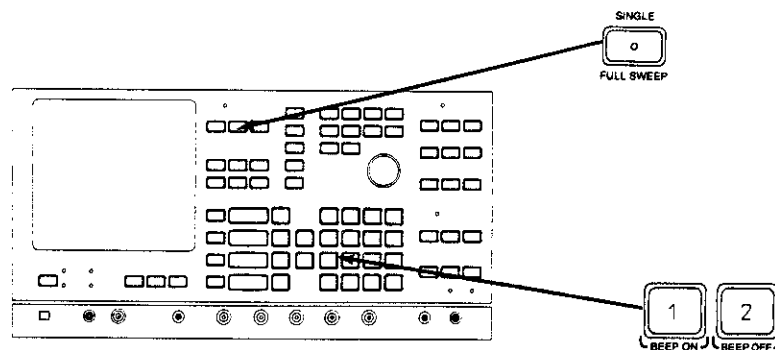

FULL SWEEP

After completing a measurement with a narrow frequency span, it is sometimes desirable to return to a full 0 Hz-to-40 MHz span, to locate the next signal to be measured, without presetting the analyzer. This can be done by pressing (blue) Full Sweep in the Sweep Section. Full Sweep may be used to quickly change the frequency sweep to the full range of the analyzer. It does not change the marker position or any other parameter value (other than start, stop, center, and span frequency), nor does it change the active status of any toggled function. With Coupled-To-Span activated, the Res. BW, Video BW, and Sweep Time parameters are coupled to frequency span and may, therefore, change when Full Sweep is pressed. The change in center frequency and/or resolution bandwidth caused by pressing Full Sweep initiates an automatic calibration.

THE BEEPER

The analyzer communicates with the operator via alphanumeric messages displayed on the screen. To call the operator's attention to these messages, it sounds an audible alerting device called a "beeper" which produces a short-duration, high pitched tone whenever a message appears on the screen. If the condition causing the message is repeated, the beeper responds, too. The beeper also sounds whenever an error is detected in the internal test routine that is performed during the turn-on sequence and each time the instrument is preset.

Beeper Control.

The beeper may be turned off by pressing the (blue) Beep Off key (under the 2 numeric key). It is turned on by pressing the (blue) Beep On key (under the 1 numeric key).

INPUT FUNCTIONS*

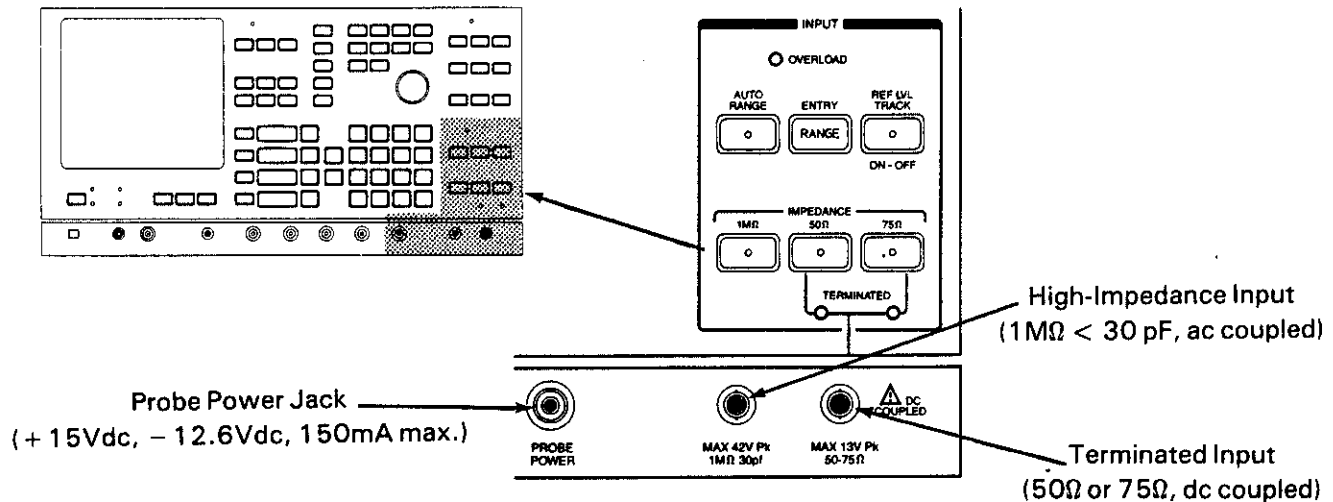

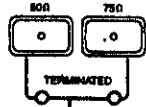

CAUTION

1. The Terminated input is dc coupled.. Peak (combined ac/dc input levels exceeding ± 13 volts will "trip" the internal protection circuit causing the input to open; but may also damage the input circuitry.
2. RF input levels exceeding ± 5.25 volts peak may damage the High-Impedance input circuitry. The combined ac/dc input level applied to the High-Impedance input must not exceed ± 42 volts peak.



- 

Activate Terminated input and select 50Ω or 75Ω dc-coupled termination. Also used to select 50Ω or 75Ω calibration impedance for dBm measurements at the High-Impedance input

Lights indicate that Terminated input is terminated in 50Ω or 75Ω, and also indicate the calibration impedance.
- 

Activates High-Impedance input; deactivates Terminated input.
- 

Sets RANGE automatically as a function of the composite ac input-signal level.
- 

Deactivates  ; prefaces RANGE, enabling it to be changed with STEP keys.
- 

Lights when ac input-signal level exceeds RANGE setting.
- 

Couples Reference Level (amplitude of top graticule line) to RANGE. Initially sets Reference Level equal to RANGE to maintain on-screen display. The Reference Level can be set equal to RANGE at any time by turning  off and then back on.

*See Chapter 4 for further information.

FRONT-PANEL TOUR
CRT Display

CRT DISPLAY OVERVIEW*

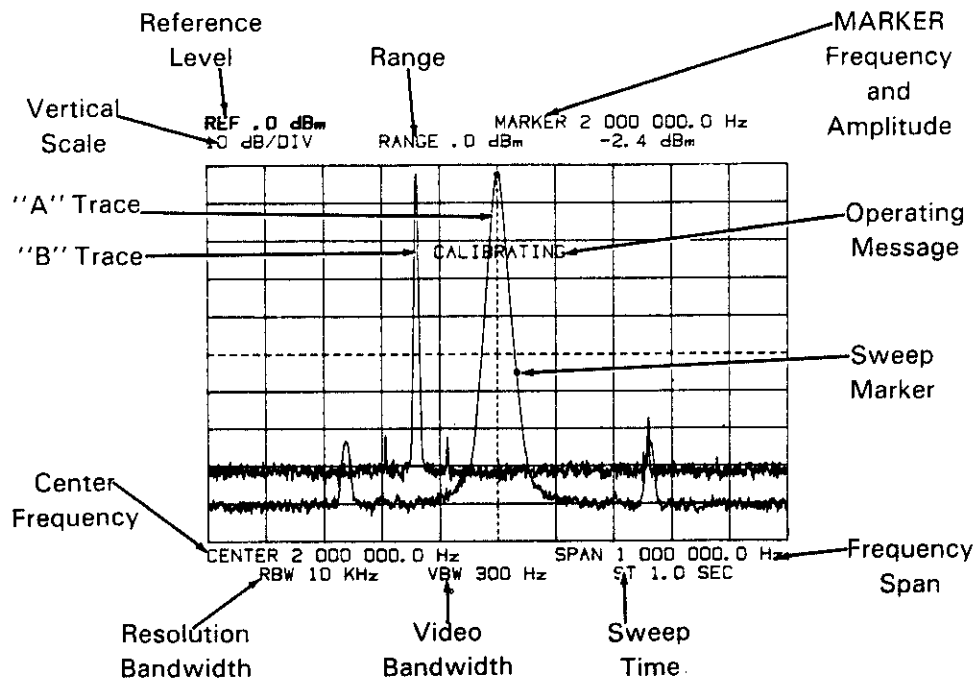

The CRT (Cathode Ray Tube) displays:

a. Graphic traces of amplitude-versus-frequency:

Two digitally-stored graphic traces, read out of Trace Memories "A" and/or "B", are written onto the CRT screen at a rapid, flicker-free rate. Each trace is a point-by-point plot, consisting of 1,001 equally-spaced points, connected by straight lines. Trace Memory "A", containing the Current ("A" or "A-B") Trace, is updated by the frequency sweep or at the Manual measurement point by real-time video samples taken at the Manual frequency. Trace Memory "B" is updated only by transfer from Trace Memory "A" with  .

*See Chapter 6 for further information.

b. Markers:

1. Tunable Marker:

Positioned by turning the knob when the marker or manual sweep is active or by marker functions such as peak search, next peak, next left, next right, and signal tracking. Used for direct measurement of on-screen responses or for measurements in the manual mode.



2. Stationary (Offset) Marker

With  activated, the stationary marker appears at the point on the CRT trace that represents the Offset reference frequency.

3. Sweep Marker:

Displayed when Sweep Time is ≥ 1 second, to indicate the position of the frequency sweep.

c. Display Line:

When the  function is activated, a horizontal Display Line appears on the CRT screen. The Display-Line amplitude can be adjusted with   to measure the trace amplitude in "dB" relative to the Reference Level (top graticule line).

d. Measurement Data:

The Frequency/Amplitude readout, in the top-right corner of the CRT screen, displays the Marker, Counter, Manual or Offset frequency and amplitude; or the Display-Line amplitude, depending on which MARKER/CONTINUOUS ENTRY functions are activated.

e. Current values of all pertinent operating parameters.

f. Operating Messages:

1. Status Messages; e.g., "CALIBRATING"
2. Entry Requests; e.g., "ENTER REG. NUMBER"
3. Operator Error Messages; e.g., "OUT OF RANGE"
4. Calibration Error Codes; e.g., "CALIBRATION ERROR 01"

g. Externally-generated graphics and alphanumerics, remotely entered via the HP-IB.

FRONT-PANEL TOUR

DISPLAY ADJUSTMENTS/TRACE FUNCTIONS

DISPLAY ADJUSTMENTS/TRACE FUNCTIONS

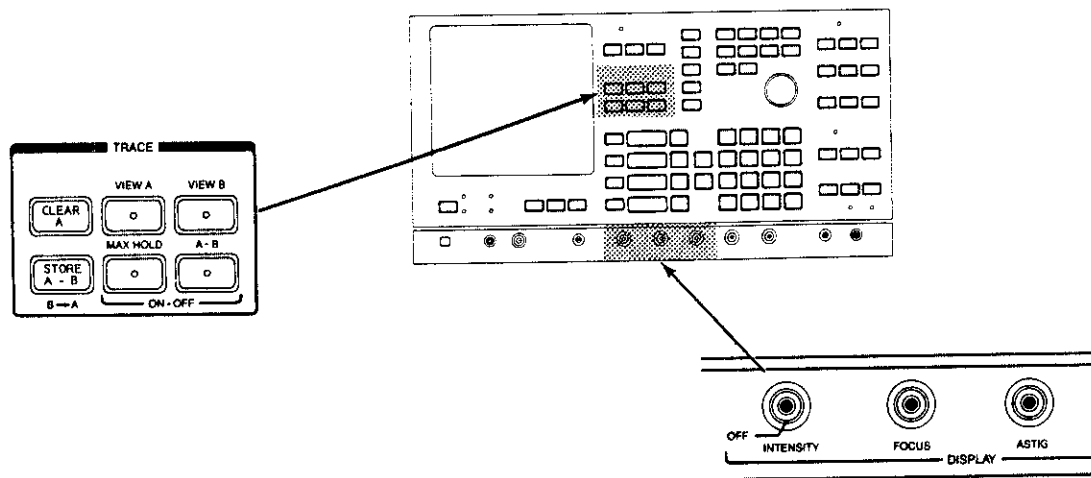

Display Adjustments



Controls the intensity of all display writing. Minimum intensity (Off) blanks the screen.



Adjusts for optimum sharpness and clarity of displayed image.



Controls background illumination on analyzers with a graticule etched on the face of the CRT. This is useful when photographing the display; the graticule grid will not show on the photo without full-screen illumination. Analyzers without the CRT-etched graticule display a grid by drawing it on the screen along with the trace and alphanumeric. Background illumination is not required for photographing the displayed grid. (The displayed grid is toggled, in either case, by pressing (blue) •, the decimal point in the numeric keypad preceded by the blue shift key.)

Trace Functions



Displays current trace stored in trace memory A (could be A or A-B).



Nondestructively transfers the current trace to trace memory B, where it is kept in nonvolatile memory until a different trace is stored or a memory-clear is performed.



Displays the trace that is stored in trace memory B.



Erases trace memory A. Resets and automatically rearms Continuous sweep; terminates Single sweep.



Subtracts trace B from trace A and writes the difference into trace A memory to produce the A-B trace.



Causes the current trace to retain the maximum positive video amplitude that occurs over successive frequency sweeps or at the manual frequency point.

KEYBOARD ENTRY FUNCTIONS

Entry Keys

Each of the analyzer's major operating parameters has an Entry key which, when pressed, prefaced a data entry for that parameter. The prefaced parameter is highlighted on the display screen to indicate that its value can be changed using the Step keys or Numeric/Units keys.

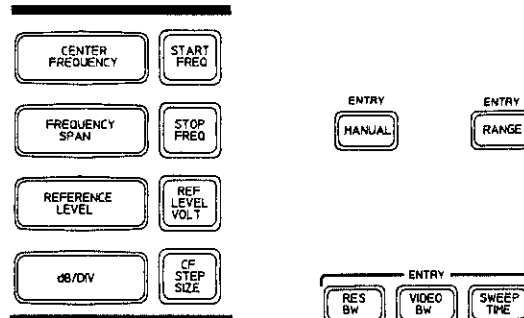

Step Keys

The Step keys increment or decrement the value of the prefaced parameter. Each press of a Step key produces a single change of the value of Step Size. Multiple step changes can be made without reprefacing. Step sizes for all parameters except center frequency and manual frequency are internally defined to either produce an appropriate amount of change or select the next available setting. Center and manual frequency steps are equal to the center frequency step size which can be set to any value within the range of 0 Hz to 40.1 MHz with 0.1 Hz resolution. Steps that would exceed the upper or lower limit of a parameter are not accepted.



Numbers/Units Keyboard

The value of any prefaced parameter (except Range) can be set exactly using the Numbers/Units keyboard. To change the value of a prefaced parameter numerically, enter the desired number using the numeric keypad and then terminate the entry by pressing the appropriate suffix (units) key. The analyzer's free-entry format allows you to make your entries in the units that are most convenient. Entries that exceed the limits of a parameter or attempt to select unavailable settings are not accepted.

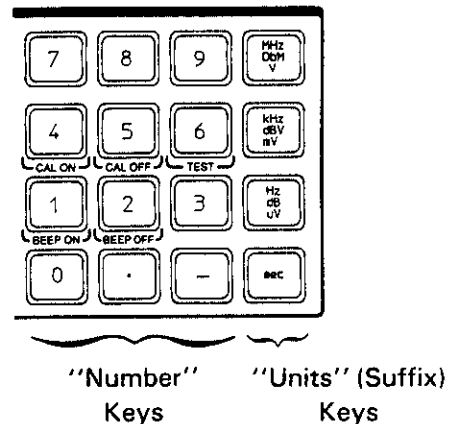

FRONT-PANEL TOUR

TRACE AND INSTRUMENT STATE STORAGE

TRACE AND INSTRUMENT STATE STORAGE

Trace Storage

There are ten trace memory registers in addition to the displayable registers for trace A and trace B. Trace A can be stored in any of the registers by pressing (blue) Save Trace A, followed by a numeric key to indicate the register number, 0–9. A stored trace can be recalled into trace A by pressing (blue) Recall Trace A, followed by the numeric key indicating the register number, 0–9.

A distinction is made between displayed trace memory (trace A and trace B) and stored trace memory. When a trace is stored in a trace register, the trace A values (in display units) are converted into dBV (or dB if A–B is active) using the current scaling parameters and then stored. When the trace is recalled, it is converted from dBV to display units. Recalling the trace with different scaling than was active when it was stored, may cause loss of precision or clipping. If A–B is active when the trace is recalled, the data in trace memory is treated as dB, regardless of how it was stored.

If A–B is active when the trace is stored, the active dB/DIV value is used to convert the current display data to relative values in dB before the data is stored. If A–B is not active, the current reference level, dB/DIV value, input impedance, and termination impedance values are used to convert the display data into dBV before it is stored. The numbers are stored in units of .01 dB or .01 dBV (e.g.; –1.72 dBV is stored as –172).

When recalling a trace from a trace memory register, the above procedure is reversed using the currently active display settings. The resulting data is rounded to the nearest integer and clipped to fit within the vertical size of the display. No frequency information is saved in trace memory; there is always a strict one-to-one correspondence between bins in the trace A display and locations in the trace memory registers.

Instrument State Storage

To save time when making a series of measurements requiring different control settings, the Save key can be used to store the current operating parameters and states of the front-panel functions in one of ten instrument state storage registers, numbered 0 through 9. The stored parameters and functions can then be recalled using the Recall key. The contents of the instrument-state storage registers are retained in non-volatile memory until overwritten by saving to the register with another instrument state.

If a recalled register contains invalid data (e.g.; by loading it over the bus), the beeper will sound (if it is active) and the message "Bad data in register" is displayed. The instrument state will then return to what it was before the recall was attempted.

NOTE

The check for bad data is not exhaustive. Recall of a bad instrument state could cause the analyzer to function improperly or become inoperative. This is not likely under normal use. If it occurs, cycle power to regain control. If the power-up state register contains corrupt data, perform a memory-clear.

Things that are saved:

1. Operating Parameters:

Range (if auto range is not active)
Reference level (and amplitude display units)
Vertical scale (dB/Div)

Frequency span
Center frequency
Manual frequency (if manual mode is active)
Center-frequency step size

Resolution bandwidth
Video bandwidth
Sweep time

2. Limit setup:

Trace register number of the lower limit
Status of View Limit
Limit mode (absolute or relative)
Status of Limit Testing (on/off)

3. States of all front-panel functions which have LED indicators

4. Marker position

5. Display-Line amplitude

6. Offset reference frequency and amplitude (whether Offset is active or not)

7. A-B 0 dB reference display position

Things that are not saved:

1. Display traces

2. Status of momentary-contact functions; e.g., MKR→CF

3. Status of :

Calibration
Beeper
Test modes
Plotter
Single-loop test mode
Tracking generator offset mode

4. Prefaced parameter

5. HP-IB status (as indicated by the Status lights)

FRONT-PANEL TOUR
BANDWIDTH/SWEEP TIME FUNCTIONS

BANDWIDTH/SWEEP TIME FUNCTIONS

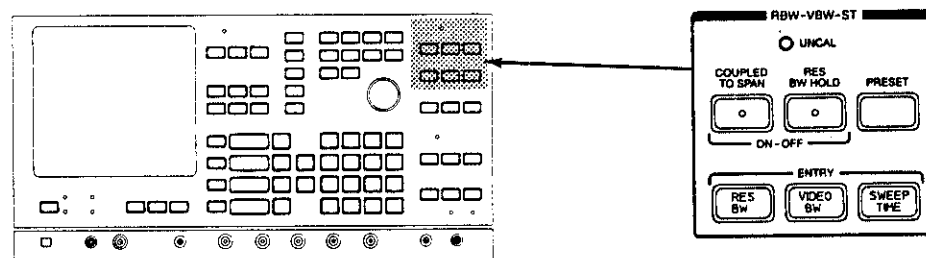

The Entry keys preface the Resolution Bandwidth (RBW), Video Bandwidth (VBW), or Sweep Time (ST) parameter value entry. The prefaced parameter can be changed by Step Entry or Numeric Entry.



Couples RBW to Frequency Span; couples VBW to RBW; automatically adjusts Sweep Time according to RBW, VBW, and frequency span. The Instrument Preset function activates Coupled-to-Span, deactivates Res-BW-Hold, and optimizes the RBW, VBW, ST coupling.



Prevents RBW and VBW from changing as a function of frequency span. Also prevents RBW (but not VBW) from changing when the BW/ST Preset key is pressed. Does not prevent Step or Numeric RBW/VBW changes.





Restores optimum RBW, VBW, and Sweep Time settings. If Res-BW-Hold is activated, pressing the Instrument Preset key restores the optimum VBW and Sweep Time, but does not affect the RBW.



Lights when manually-selected sweep rate is too fast to maintain calibration. Accuracy specifications are met *only* when this light is not illuminated.

OPERATION WITH BANDWIDTH/SWEEP TIME COUPLING:



To begin a measurement, the operator normally presses . This activates , deactivates  and sets the Frequency Span to 40 MHz. It also sets the RBW and VBW to 30 kHz and the Sweep Time to 0.2 seconds. These are the preferred or "optimum" settings for the full 40 MHz Span.

After connecting the signal source, the operator adjusts the Center Frequency and Frequency Span (or Start and Stop Frequencies) to display the signals of interest. During this process, the Resolution Bandwidth is automatically narrowed as a function of Frequency Span to maintain a good aspect ratio and provide an appropriate amount of frequency resolution. Since the Video Bandwidth is coupled to Resolution Bandwidth, it changes along with the RBW to maintain proportional display smoothing. The Sweep Time is mathematically calculated according to the RBW, VBW and Frequency Span, and is automatically adjusted to maintain the maximum-calibrated sweep rate or the analyzer's minimum Sweep Time of 0.2 seconds.

Once the frequency parameters have been set, the operator can freely adjust the RBW and/or VBW settings to obtain the required resolution, sensitivity and display smoothing. With optimized Sweep Time coupling, the Sweep Time is automatically adjusted to maintain the optimum sweep rate. If desired, the Sweep Time can be increased from the optimum setting to minimize the effects of sweep dynamics; or it can be decreased (at the cost of calibration) to quickly survey the spectrum of interest.

The coupling system is very flexible and will allow the operator to select any available RBW, VBW, Sweep Time combination. It will then remember and, where possible, maintain the relationships established by the operator. The optimum settings can be restored by pressing the  key.

For applications such as horizontal expansion, it is desirable to maintain a specific RBW setting and adjust the Frequency Span, while allowing the coupling system to automatically adjust the Sweep Time. This can be done by activating the  function.

If the operator does not wish to use the coupling system, it can be completely disabled by deactivating the  function. (The UNCAL indicator and PRESET key are operative whether or not the  function is activated.)



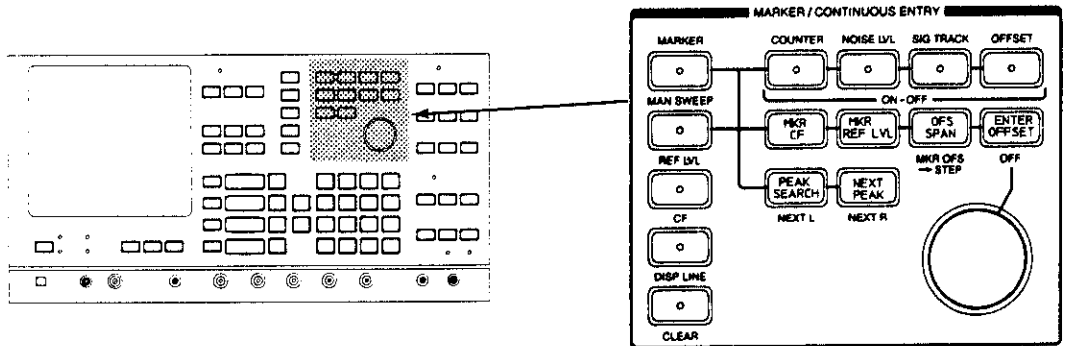

MARKER/CONTINUOUS ENTRY FUNCTIONS*

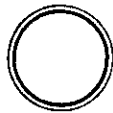

Continuous Entry Functions



The Continuous Entry control is a multi-purpose "digital potentiometer" whose function is selected using the Continuous Entry keys. (Only one Continuous Entry Function can be activated at a time.) It can be used with:

-  to position the tunable Marker for measurement of on-screen responses.
-  to tune the Manual frequency.
-  to adjust the Reference Level.
-  to adjust the Center Frequency.
-  to adjust the Display-Line amplitude.

Continuous Entry Functions

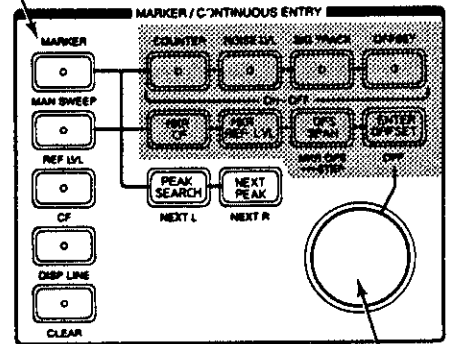



Continuous Entry Control

*See Chapter 8 for further information.

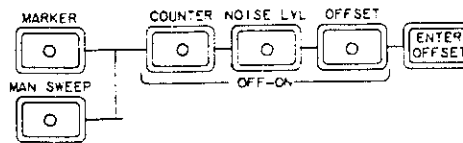
Marker/Manual Measurement Functions



Marker

Measure absolute frequency and amplitude of on-screen responses with  

(The Marker amplitude can be displayed in dBm (50Ω or 75Ω), dBV or rms volts. The Marker's frequency resolution and accuracy is limited by the point-by-point display and sweep dynamics.)

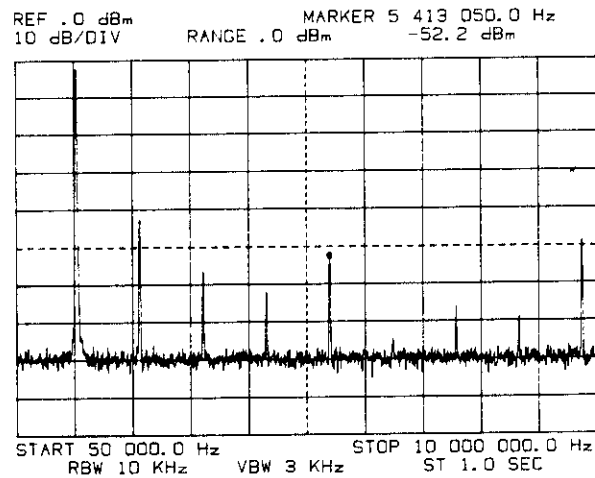

REF .0 dBm
10 dB/DIV

COUNTER 11 123 456.7 Hz
RANGE .0 dBm
-24.0 dBm

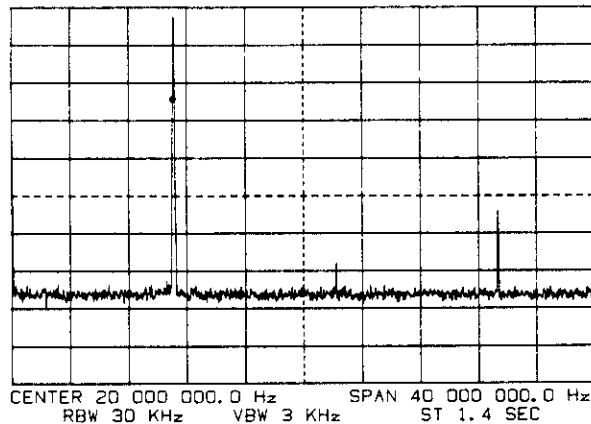

Counter

Use the  function to precisely measure the frequency of the signal that is producing the response on which the Marker is positioned.

(The Counter, unaffected by display resolution and sweep dynamics, displays the true frequency at the peak of the response. The Marker does not need to be at the peak of the response, but it must be at least 20 dB above the noise and 20 dB above any unresolved signal.)

Noise Level

The  function provides a direct real-time reading of the rms random noise spectral density at the Marker or Manual frequency, normalized to a 1 Hz noise power bandwidth. All correction factors are included in the internal noise-measurement routine.

(Absolute noise level readings are displayed in "dBm (1 Hz)", "dBV (1 Hz)" or " $V\sqrt{Hz}$ ". Relative (Offset) noise readings are displayed in "dB (1 Hz)". Noise measurement times range from 0.3 seconds to 33 seconds, depending on the Resolution Bandwidth setting.)

REF .0 dBm
10 dB/DIV

COUNTER 1 150 833.7 Hz
RANGE .0 dBm
-107 dBm (1Hz)

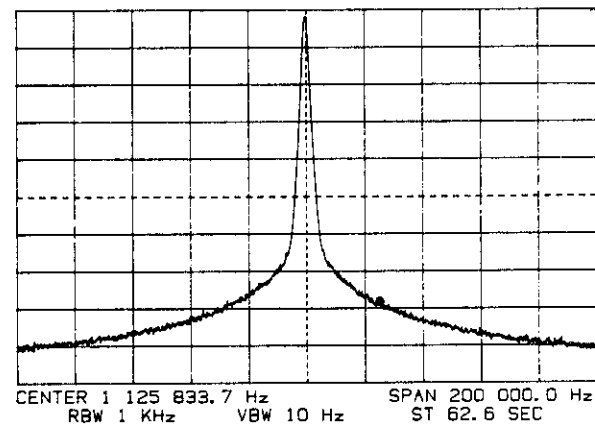

FRONT-PANEL TOUR

MARKER/CONTINUOUS ENTRY

Signal Tracking



Signal tracking is an on/off feature in the Marker/Continuous Entry section that can be activated during continuous sweeps to find a peak near the marker position, move it to the center of the display, and adjust the analyzer's center frequency to keep the peak at the center of the display. This "search and center" process occurs after every sweep while tracking is active. If the peak changes frequency between sweeps, the tracking feature changes the analyzer's center frequency to the new frequency of the peak.

Offset Function



The Offset function allows you to quickly measure the relative frequency and amplitude between two points of interest within the measurement range of the analyzer. It can be used in conjunction with the marker or manual sweep functions to make relative measurements at the marker or manual frequency. It operates with the counter function to count the frequency difference between two points of interest on a trace. It also operates with the noise level function to measure signal-to-noise ratio.

To use the marker offset feature:

1. Move the marker dot (by turning the knob) to the point on the trace from which you wish to make a relative measurement; e.g. the fundamental frequency of a signal source.
2. Activate the Offset function by pressing the Offset key (with a light in the center). The key's light turns on and "MARKER" changes to "OFFSET" in the upper-right corner of the display.
3. Enter the present position of the marker into the offset registers by pressing the Enter Offset key. This changes the offset values to .0 Hz and .0 dBm.
4. Move the marker to another point on the trace. The readout in the upper-right corner of the display is now relative to the point entered in step 3.

NOTES

1. A stationary point remains at the point on the trace at the offset reference value.
2. Offset amplitude readings are displayed in dB units, only.
3. Appendix 3-A contains a programming example in which an offset reference point is set which is not on the measurement trace. This is only possible in remote operation.

Marker/Offset Entry Functions

The Marker/Offset entry functions are time-saving, single-key, operating aids which allow the operator to quickly perform frequently-used manipulations such as centering a signal and moving it to the top of the screen or finding the frequency with largest amplitude value. These functions also make it easy to enter an arbitrary frequency span, "zoom in" on a signal of interest, or enter the center frequency step size.



Put marker value in center frequency. This sets the center frequency value to that of the current marker, counter, or manual frequency value, and moves to the center frequency point on the display trace. To quickly move a response to the center of the screen, set the marker to the point of interest with the knob and then press Mkr→CF.



Sets the reference level equal to the marker amplitude, moving the point on the trace marked by the marker dot to the top line of the display grid.



Sets frequency span equal to the displayed offset frequency. This function operates only when the Offset function is activated. Move the marker to the desired start frequency, press the Offset key (the key's light turns on), move the marker to the desired stop frequency, and press the OFS→Span.



Put marker frequency offset value (or marker, counter, or manual values, whichever is active) into the center frequency step size (or manual frequency step size). This is a shifted function activated by first pressing the blue shift key and then OFS→Span. The function label appears in blue under the key. See "The Blue Key" in Chapter 1.



The Peak Search function moves the marker to the point on the trace representing the largest amplitude. It also activates the knob to control the marker. If several points have the same peak value, the marker is moved to the lowest frequency which has that value. See discussion in Chapter 8.



Next Peak. This function moves the marker to the peak with next-largest value, relative to the current marker position and activates the knob to move the marker. Peaks with amplitudes equal to and to the left of the current marker position are ignored. If one or more peaks of equal amplitude exist to the right of the current position, the marker is moved to the one nearest the current position. If there is no peak that satisfies the next-peak criteria, the analyzer beeps when the key is pressed (if the beeper is active) and the marker is not moved.



Next Peak Left or Right. This function moves the marker to the next peak left of (lower frequency) or right of (higher frequency) the current marker position. If a new peak is found, the knob is activated to move the marker. If there is no peak that satisfies the next-left criteria, the analyzer beeps when the key is pressed (if the beeper is active) and the marker is not moved.

FRONT-PANEL TOUR
Sweep/Trigger

SWEEP AND TRIGGER FUNCTIONS

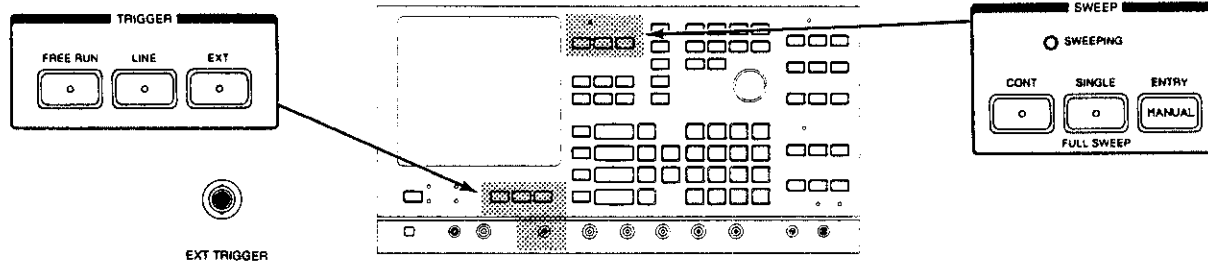

Sweep Functions:



Lights to indicate that a frequency sweep is in progress. Goes out between sweeps and during mid-sweep interruptions.



Repetitive frequency sweeps synchronized by sweep trigger. Upon completion of each sweep, the sweep is automatically rearmed and a new sweep is initiated on receipt of a sweep trigger. Pressing  resets the sweep that is currently in progress (except when switching from Single).



Single frequency sweep initiated by sweep trigger. Once a Single sweep has terminated, it resets to the Start Frequency to await rearming. Pressing  (except when switching from Cont.) resets and/or rearms the sweep, enabling a new sweep to be initiated by a sweep trigger.*



Selects Manual mode; automatically activates ; sets Manual frequency equal to current Marker frequency; prefaces Manual frequency, enabling it to be changed by Step or Numeric Entry.

Trigger Functions:



Sweep automatically triggered after rearming.



Sweep internally triggered at power-line frequency (48 Hz to 440 Hz).



Sweep triggered by High-to-Low transition or contact closure at EXT TRIG input.*



EXT TRIGGER

High = open or +2.0V to +35V; Low = short to ground (outer shell) or +1.3V to -35V. Sweep triggered by High-to-Low transition; triggers are accepted only after the sweep has been rearmed. (Rearming time ranges from about 25 milliseconds to 2.4 seconds, depending on RBW/VBW settings.) Triggers applied during a sweep or during rearming are ignored.

*Sweep rearming and triggering operations are inhibited during Automatic Calibrations and also while operating parameters are being changed.

LIMIT TESTING

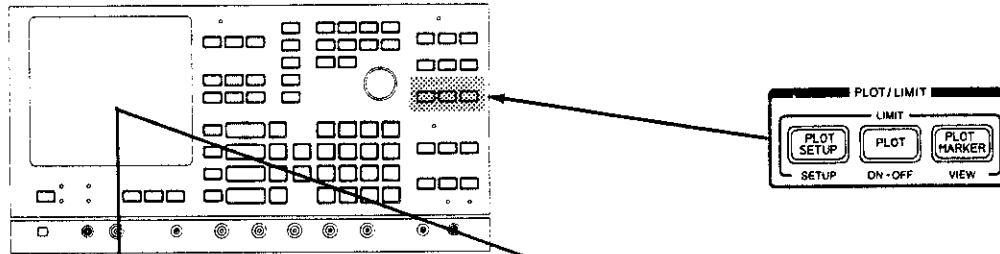

LIMIT SETUP MENU

Key 7: Anchor vector (then horizontal motion)
 Key 8: Anchor vector (then vertical motion)
 Key 9: Finish moving line*

Key 4: Start new limit line
 Key 5: Select limit registers
 Key 6: Select limit mode: ABSOLUTE

Key 0: Save lower limit
 Key 1: Save upper limit
 Key 2: Recall lower limit
 Key 3: Recall upper limit

Lower limit is trace register 0
 Upper limit is trace register 1

press PLOT SETUP to exit menu

All entries shown

LIMIT SETUP MENU

Key 7: Anchor vector (then horizontal motion)
 Key 8: Anchor vector (then vertical motion)
 Key 9: Finish moving line*

→ Turn knob to move line vertically
 Key 5: Select limit registers
 Key 6: Select limit mode: ABSOLUTE

Key 0: Save lower limit
 Key 1: Save upper limit
 Key 2: Recall lower limit
 Key 3: Recall upper limit

Lower limit is trace register 0
 Upper limit is trace register 1

press PLOT SETUP to exit menu

Ready to define new limit trace

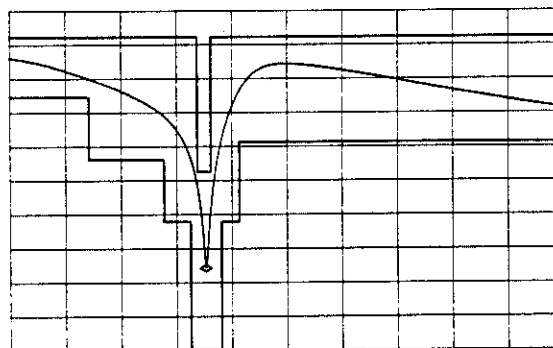

Measurement trace bounded by upper and lower limit traces

Limit testing uses two user-defined traces as upper and lower boundaries for testing the response of a measurement trace as shown in the figure above. The limits are two traces composed of vectors or line segments. The two limit traces are defined individually and stored in trace registers 0-9. They may be created manually (using tasks in the Limit Setup Menu), with HP-IB commands, or by storing measurement traces.

FRONT-PANEL TOUR

LIMIT TESTING

There are three Limit keys selected by first pressing the (blue) shift key:



Limit Setup is a shifted function which displays a menu of tasks used to create, save, and recall limit traces. If the B trace is displayed, it continues to be displayed in the Limit Setup Menu. This allows a displayed trace while limits traces are created.



Limit On/Off is a shifted function which turns limit testing on or off (toggle). Uses the currently-selected register pair shown in the Setup menu. When on, the limit-test algorithm compares the values of the measurement trace with the limits traces. It passes if the lower limit is \leq measurement trace and the measurement trace is \leq the upper limit. If the test fails, the analyzer beeps (if the beeper is active), and an error message appears.



View Limit allows the limits traces to be displayed with a measurement trace. Limits traces are turned off by pressing (blue) View, again. The limit traces are displayed as two dashed lines representing the upper and lower amplitude limits. This is done with a "chopped" trace alternating between the upper and lower limit traces.

The general setup procedure for limit testing is listed and each step described in the following discussion:

1. Set up the analyzer to make the desired measurement.
2. Set up the test limits (Limit Setup key).
3. Turn limit testing on (Limit On/Off key).
4. Display the limits trace (View Limit key)(optional).

Measurement Setup.

The analyzer should be set up for the measurement before setting the test limits; especially the frequency range. The limits traces' amplitude values are stored in dB or dBV, so they adapt to changes in range, reference level, and scale made during a measurement. The horizontal units, however, do not change when the measurement frequency range is changed.

Setting Limits.

Setting limits is accomplished in the Limit Setup Menu. To display this menu, press the (blue) Limit Setup key in the Plot/Limit key group. The Limit Setup Menu identifies the currently selected limits register pair (bottom of screen) and lists the tasks with the corresponding numeric keys that activate them.

Limit Setup tasks are selected by pressing keys in the numeric keypad as defined in the menu. When a selection is made, its menu entry changes into an instruction emphasized by an arrow in the left margin. The Limit Setup tasks are used to define a new limit trace, save or recall a limits trace, or select the register pair to save the trace to or recall the trace from. To exit the Limit Setup Menu, press the Plot Setup key.

You can view a measurement trace in the Limit Setup menu by copying the A trace into trace B with the Store A→B key (before getting into the Limit Setup Menu) and then viewing the B trace by pressing the View B key.

Creating a Limit Trace. When you first enter the Limit Setup Menu, a bright trace appears at the bottom of the screen with a bright dot at the far left. The knob is in control of the vertical position of the line. To create a new limit trace:

1. Position the line (by turning the knob) at the baseline of the limit you want to create.
2. Press the 9 key to "Finish moving line."
3. Define a vector.
 - a. **Position the dot** (with the knob) at the starting point of the vector you wish to create. If the start of the next vector is the same as the end of the last one, *don't turn the knob.*
 - b. **Press the 7 key.** (see note 2) This anchors the vector (defines the beginning end point of the vector as the current position of the dot) and activates the knob to move the marker dot horizontally.
 - c. **Turn the knob** to move the dot to the horizontal coordinate of the vector end point.
 - d. **Press the 8 key.** This allows the knob to move the dot vertically.
 - e. **Turn the knob** to move the dot to the vertical coordinate of the vector end point.
 - f. **Press the 9 key** to enter the definition of the new vector.
4. Repeat step 3 until the entire limit trace is defined.
5. **Save the newly-defined limit.** (see note 1)
 - a. Select the trace memory register pair to save the new limit trace in.
 - i. Press the 5 key to select the memory register pair. Notice that the currently selected pair is highlighted at the bottom of the display.
 - ii. Press a numeric key 0-8 corresponding to the lower limit trace memory register desired. **The upper limit is always the next larger numbered register.**
 - b. Save the limit trace as either:
 - the lower limit, by pressing the 0 key, or
 - the upper limit, by pressing the 1 key.

NOTES

1. If you don't save the limit trace, it will be lost when you begin to define another limit line, recall another limit trace, or exit the setup menu.

2. In step 3, you may begin defining a vector by pressing either the 7 or the 8 key. Also, you don't have to press both if your .

3. Vectors are defined from left to right, only. You can't anchor a vector and move left of the starting point.

4. The position readout of the dot appears in the upper-right annotation while the limit setup menu is displayed. If the Marker Offset is active when Limit Setup is selected, the readout is relative to the offset

5. Saving limit traces overwrites information in the selected trace memory register. Be sure to check the contents of the register before saving new data into it. Use the (blue) Recall Trace A key, followed by the register number of interest to display the trace memory information.

6. The limits coordinates adapt to changes in scale and reference level (vertical coordinates) but not to changes in frequency range (horizontal coordinates).

FRONT-PANEL TOUR

LIMIT TESTING

Saving/Recalling Limits. The limit traces are stored in pairs in the trace memory registers (0 through 9). The default trace memory registers used for storage of the trace limits are registers 0 and 1. The two are always consecutive. The user picks the lower-numbered register, which is used for the lower limit, and the analyzer uses the next-greater register for the upper test limit. The user selection may be 0 through 8.

Remote control allows the user to define a trace on the analyzer and move it to the controller where it and many other traces can be stored and recalled for later use. This is especially useful if you need more than five limits setups. Or, the trace can be generated on the controller and loaded in the analyzer (see the BD and BL commands in Chapter 9). This can be used to generate smooth curves.

Measurement traces may be used as limits traces by saving trace A into registers with the (blue) Save Trace A key (and an appropriate register number), and then recalling the trace as a limit in the Limit Setup Menu. Refer to "Using a Measurement Trace as a Limit" later in this discussion.

NOTES

- 1. Since the limits trace pairs are stored in trace memory locations, saving a limit trace can overwrite another limit trace or stored measurement trace. Conversely, measurement traces may overwrite registers storing limits traces when the Save Trace A key is used.*
- 2. Sections of either limit trace at the extreme bottom or the extreme top of the display are effectively $-\infty$ and $+\infty$, respectively, when they are stored while in the limit setup menu. Traces stored by pressing (blue) Save Trace A are saved just as they appear in the display.*

Selecting Limit Mode. There are three modes that the limit testing feature can work in: absolute, relative, or A-B. In absolute mode, the limit registers are always treated as dBV and compared to the measured values in dBV. Absolute mode is selected by making sure A-B is off and then selecting Absolute by pressing key 6 in the numeric keypad (toggles between absolute and relative) while the limit setup menu is displayed. This is the default condition selected by Instrument Preset.

In the relative mode, the limit registers are assumed to contain data in dB with respect to the reference level; i.e.; the limits always appear at the same place in the display unless the dB/DIV parameter is changed. Relative mode is selected by pressing key 6 in the numeric keypad (toggles between absolute and relative) while the limit setup menu is displayed.

In the A-B mode, the limit registers assumed to contain data in dB with respect to the A-B reference point which is normally the center graticule line. A-B mode is selected by first activating the A-B feature and then selecting Absolute by pressing key 6 in the numeric keypad (toggles between absolute and relative) while the limit setup menu is displayed.

Turning Limit Testing On.

When a measurement trace is displayed with limit testing on, the analyzer compares the trace values with the values of the limit traces. This comparison is made after a sweep is complete. If there is any measurement trace value that is less than the lower trace limit or greater than the upper trace limit, the limit test fails. In Manual Sweep mode, the test is made after every reading and only that reading is compared to the limits. If a failure occurs, the analyzer beeps (if the beeper is on), places an "X" on the trace at the left-most failure point, and displays the error message "Limit Test Fail."

NOTE

Avoid defining upper and lower limit trace-pairs which intersect each other. Any point at which the value of the lower limit trace is greater than the value of the upper limit constitutes an automatic failure condition.

To turn on limit testing:

1. Select the limits traces you wish to use.
 - a. Press the (blue) Setup Limits key in the Plot/Limits key group to display the setup menu.
 - i. Press the 5 key to select the memory register pair. Notice that the numbers of the currently selected pair are highlighted at the bottom of the display.
 - ii. Press a numeric key 0-8 corresponding to the lower limit trace memory register desired. The upper limit is always the next larger numbered register.
 - b. Press the Plot Setup key in the Plot/Limit front-panel section to exit the Limits Setup menu.
2. Press the (blue) Limit On/Off key in the Plot/Limit key group. This turns limit testing on but does not display the limits traces. (See the discussion on Viewing Traces in the following discussion.)

FRONT-PANEL TOUR

LIMIT TESTING

Viewing Limits.

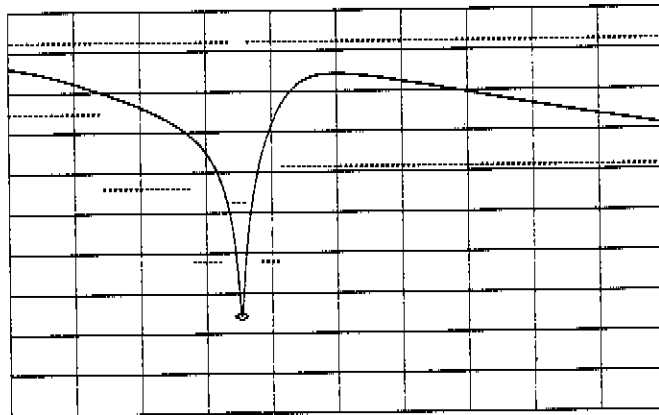

Limit traces displayed

To view the trace limits as currently selected in the Limit Setup menu, press the (blue) View key in the Plot/Limit key group. The limits are displayed as two dashed lines. If changes are made to the range, reference level, or scale (dB/Div), the limits traces automatically update themselves.

NOTES

- 1. Any part of the limits traces where the lower limit value is greater than the upper limit value is not displayed. For example, if the entire lower limit trace is defined to be larger than the upper limit, no limit traces are displayed when View Limits is activated.*
- 2. To turn View Limits off, press (blue) View again.*

Editing Limit Traces.

Changing the definition of a limit trace is done by redefining parts of an existing trace. This differs from creating a new trace in that you first recall the trace. Vectors are "edited" by replacing the old vector with a new definition.

Enter the Limit Setup menu by pressing the (blue) Setup key in the Plot/Limit key group.

To edit an existing limit trace:

1. Recall the limit trace to be edited.
 - a. Select the trace memory register pair containing the limit trace of interest.
 - i. Press the 5 key to select the memory register pair. Notice that the currently selected pair is highlighted at the bottom of the display.
 - ii. Press a numeric key 0-8 corresponding to the lower limit trace memory register desired. The upper limit is always the next larger numbered register.
 - b. Recall:
 - the lower limit, by pressing the 2 key, or
 - the upper limit, by pressing the 3 key.
2. Define a vector.
 - a. Position the dot (with the knob) at the starting point of the vector you wish to create. If the start of the next vector is the same as the end of the last one, *don't turn the knob*.
 - b. Press the 7 key. This anchors the vector (defines the beginning end point of the vector as the current position of the dot) and activates the knob to move the marker dot horizontally. (You could press either the 7 or 8 key to initiate the new vector.)
 - c. Turn the knob to move the dot to the horizontal coordinate of the vector end point.
 - d. Press the 8 key. This allows the knob to move the dot vertically.
 - e. Turn the knob to move the dot to the vertical coordinate of the vector end point.
 - f. Press the 9 key to enter the definition of the new vector.
3. Repeat step 2 until editing is complete.
4. Save the limit.
 - a. Select the trace memory register pair in which to save the new limit trace. If you want to use the limit trace register pair currently selected, skip to step b.
 - i. Press the 5 key to select the memory register pair. Notice that the currently selected pair are highlighted at the bottom of the display.
 - ii. Press a numeric key 0-8 corresponding to the lower limit trace memory register desired. The upper limit is always the next larger numbered register.
 - b. Save the limit trace as either:
 - the lower limit, by pressing the 0 key, or
 - the upper limit, by pressing the 1 key.

FRONT-PANEL TOUR

LIMIT TESTING

Using a Measurement Trace as a Limit.

A measurement trace can be used to define the limits traces. Since the limits traces are stored in the same memory registers as the measurement traces, you can take a measurement, shift it up or down, save it in a trace register, and use it as a limit trace. Remember, the limit registers are used in pairs and the lower-numbered register is the lower limit. The following procedure utilizes this method of creating limit traces:

1. Set up the analyzer using single sweep mode
2. Take a single sweep measurement
3. Lower the reference level by the amount of the lower margin
4. Save trace A in the trace register to be used as the lower limit (0-8; for this example, use 2)
5. Raise the reference level above that of the measurement by the amount of the upper margin
6. Save trace A in the trace register just above that used in step 4 (would have to be 3)
7. Now select the register pair (in this example, 2 & 3) as limits from the Limit Setup menu as described previously.

The trace data is saved in dBV (or dB if A-B is active). This is calculated from the display memory (contains display position information, only) and the active scale and reference level selections. The procedure listed above stores traces shifted up or down by the amount of reference level change entered in steps 3 and 5. This is especially useful if you have a "golden" filter against which you wish to test a production run.

NOTE

When you exit the Limit Setup menu in the above procedure, a sweep will begin from the position of the marker, even though single sweep is active. Selecting external trigger before entering the Limit Setup Menu eliminates this extra sweep (unless there is an external trigger signal present).

PLOTTING

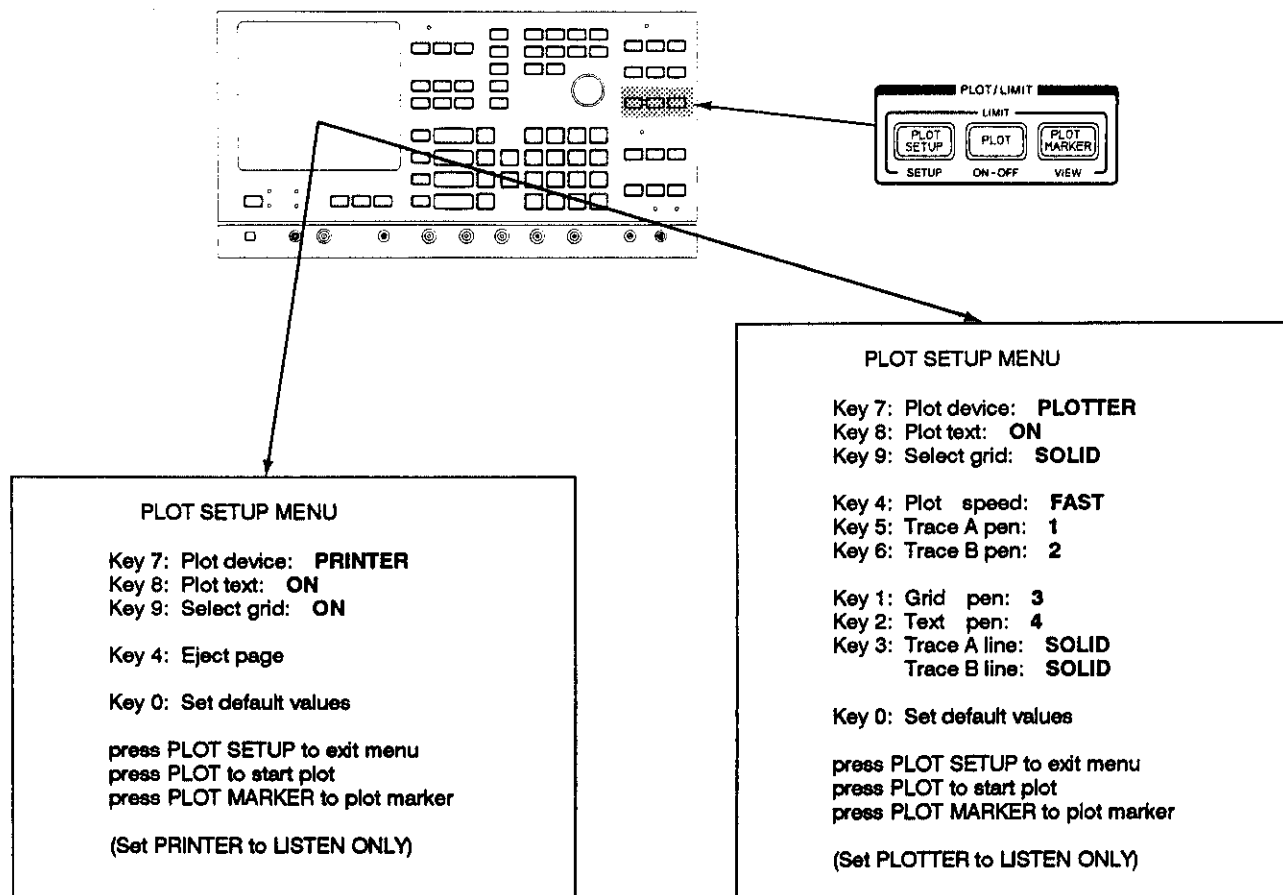

The 3585 can drive an HP-GL plotter or raster graphics printer (with an HP-IB interface) to create a copy of the display on paper. It does so by using the rear-panel HP-IB interface. The plotter/printer must be addressed to listen-only and all controllers must be removed from the bus. There are three keys which control the plot functions.



Pressing the Plot Setup key displays a menu used to set the plotter/printer. This menu allows you to select the device (plotter or printer) and all the options associated with that device. The menu selections are made by using numeric keys as indicated.



Pressing the Plot key starts a plot or print (depending on the device selected in setup). The plot may be aborted by pressing the Instr Preset key. See "Aborting the Plot."



If the marker dot is displayed and the selected device is a plotter, pressing the Plot Marker key plots a marker diamond at the marker position on the trace and writes marker frequency and amplitude values near the new marker position, as shown on the analyzer display. If the device is a printer, pressing the Plot Marker key prints the marker information in one line of text on the printer. If no marker dot is displayed, Plot Marker causes a beep (if the beeper is active) and no other action occurs.

FRONT-PANEL TOUR

PLOTTING

When the marker dot is displayed, pressing the Plot Marker key writes whatever information is displayed in the upper-right corner next to the diamond symbol on the trace. This information includes counter information, noise level, or offset values. Plot Marker is normally used after a plot is made with the Plot key.

The Plot and Plot Marker keys may be used without first accessing the Plot Setup menus. However, the options defined there determine the plot configuration used. The plot options are not changed by pressing Instrument Preset, redefining the instrument state (e.g., by recalling a state register), or by cycling power.

Set Up the Hardware.

When the 3585 talks to a plotter or printer, there must be no controller connected to the bus. When you press the Plot or Plot Marker keys, the 3585 checks for listening devices and controllers connected to the bus. There should be at least one device on the bus which is listening and no controllers. If no listener is detected, the analyzer displays the message "No Listener on bus!" If it detects a controller it displays the message "Controller on bus." (Plotting in remote operation is a special case covered in Chapter 9 and Appendix 3-A, Programming Examples.)

Remove any controllers from the bus by disconnecting their HP-IB cables or turning off their power. Set the desired plotter or printer to listen-only or the HP-IB address that corresponds to listen-only (refer to the device's reference manual). Connect the plotter to the analyzer with an HP-IB cable. Set up the plotter with the paper and pens and set P1 and P2 (corner points) as desired. The analyzer scales the plot to fill the P1-P2 rectangle. A printed plot is done at the printer's default resolution. The graphics portion of the printout has a width of 520 pixels and a height of about 350 pixels. The 3585 does not reconfigure the printer.

Set Up the Display.

Set the display to appear as you wish the plot to appear. Text¹, displayed traces, and the display line are plotted as they appear on the display. Marker dots are plotted as diamond symbols. Bus commands may be used to display special script and annotation text, which is also plotted. The text at the top and bottom of the display and the grid² are controlled by selections in the plot setup menu. If they are turned off, they will not appear on the plot. (In the case of a plotter, the grid may also be set to dashed, besides being on or off.) Error messages and bus-debug characters are not plotted.

- 1 The appearance of the screen text is determined by the analyzer setup. Whether it is plotted or not is determined by a selection in the Plot Setup menu.
- 2 Turning the grid display off has no effect on the grid plot status; a grid is plotted unless it is turned off in the plot menu. See earlier discussion on displaying the grid.

Options.

Pressing the Plot Setup key displays the menu used to set up the plot options. Pressing key 7 (in the numeric keypad) toggles between the plotter menu and the printer menu.

Plotter. (See menus on earlier page.) The plot-text option is toggled on and off by pressing key 8. The select-grid option sequences through three choices (solid, dashed, and off) when key 9 is pressed. Plot speed is selected by pressing key 4 which toggles it either fast (actual speed is device-dependent) or slow (5 cm/sec). Pen selection for each trace, the grid, and the screen text is made by pressing a numeric key to identify the item and then pressing another numeric key (1–8) corresponding to the plotter pen to be used for that item. Limits traces are plotted with the pen selected for text. The display line is plotted with the pen selected for trace B. If B is not plotted, the pen selected for trace A is used to plot the display line.

The trace line-type is either dashed or solid. With two possible traces, there are four possible combinations of line types. Pressing key 3 repeatedly sequences through these four combinations. Pressing key 0 resets all entries in the displayed menu to their default settings (see menu on previous page).

Printer. The printer options allow control over the screen text and grid. The text is toggled on or off by pressing key 8. The grid is toggled on or off by pressing key 9. Pressing key 4 sends a form-feed command to the printer. Pressing key 0 resets the menu entries to their default setting; text on and grid on.

Aborting the Plot.

When the Plot or Plot Marker keys are pressed, the analyzer displays the message "Inst Preset to Abort" and begins sending HP-GL commands to the device. If the Instrument Preset key is pressed, the analyzer quits sending the HP-GL commands that draw the display and sends commands to put the pen away and park the pen holder near P2. During this "cleanup" action, the message "Aborting Plot . . ." is displayed. When the cleanup commands are transferred to the plotter, the analyzer returns to the measurement which was in progress when the plot key was pressed.

The abort request is only effective during the analyzer-plotter bus interaction. If the plot device buffers up the HP-GL commands (storing them in memory until the hardware is ready for the next instruction), the bus interaction may be completed long before the plotted drawing is finished. When the analyzer has sent all the plot commands, it removes the abort-plot message from the display and returns to the measurement in progress before the plot key was pressed. Pressing Instr Preset after the analyzer has returned to the measurement does not stop the plotter; it resets the analyzer.

While the "Aborting Plot" message is displayed, you can press the Instr Preset key a second time, which causes the analyzer to leave the plot routine, returning to whatever measurement was in progress when the plot key was pressed. This is useful if the plotter malfunctions or "hangs" during a plot and does not respond to the abort request. This action terminates the cleanup action early and may leave a pen in the plotter arm.

NOTE

An aborted plot cannot be restarted. It must be started again from the beginning.

FRONT-PANEL TOUR
Status Functions

HP-IB STATUS FUNCTIONS*

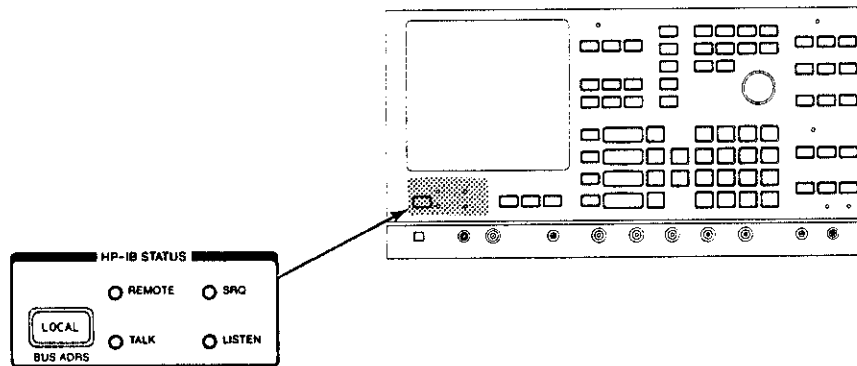

REMOTE

Lights to indicate that the 3585 is in the Remote control mode. This mode can be entered only via the HP-IB.

(When the 3585 is in Remote, all front-panel functions except the LINE switch, the DISPLAY controls, the Tracking Generator AMPLITUDE control and the LOCAL key are disabled. Pressing any key (except LOCAL or INSTR PRESET) or rotating the Continuous Entry control will cause the beeper to sound and the message, "HP-IB REMOTE SET" to appear on the CRT screen.)

LOCAL

Returns the 3585 to Local and reenables all front-panel functions. An HP-IB Local Lockout will disable LOCAL until a remote Return To Local command is given, or the LINE switch is turned off and then back on.

(Pressing LOCAL during an HP-IB Local Lockout causes the beeper to sound and the message, "HP-IB LOCAL LOCKOUT" to appear on the CRT screen.)

LISTEN

Lights to indicate that the 3585 is addressed to listen.**

TALK

Lights to indicate that 3585 is addressed to talk.

SRQ

Lights to indicate that the 3585 is generating an HP-IB Service Request.

*HP-IB operation is fully described in Section III, Part 2.

**The LISTEN or TALK light will remain on (even in Local) until the 3585 is unaddressed via the HP-IB or is turned off and then back on.

AUTOMATIC CALIBRATION

One of the major features of the 3585 is its ability to calibrate automatically, thus eliminating the need for external calibration adjustments. The purpose of Automatic Calibration (Auto. Cal.) is to compensate for minor amplitude and frequency offsets that are normally present in the instrument's analog section. It is also used to compensate for frequency drift in the Tracking Generator to insure that the Tracking-Generator frequency is always within ± 1 Hz of the analyzer's tuned frequency. The Automatic Calibration is performed by the 3585's Central Processor, in conjunction with the Tracking Generator and a highly accurate internal calibration source.

During each Auto. Cal. cycle, the output of the internal calibrator is switched into the Terminated input channel and a 50 Ω or 75 Ω dummy load is switched across the Terminated input to maintain the proper input termination. Amplitude errors appearing at the Reference Level and Center Frequency or Manual frequency are then minimized or eliminated by the adjustment of internally-programmable parameters such as the local-oscillator frequency, IF gain and video level. Attenuator errors, and any residual amplitude errors that cannot be adjusted out, are stored in memory as Auto. Cal. constants and are corrected mathematically.

The following is a list of common questions and answers concerning the 3585's Automatic Calibration feature. A review of this list should provide you with sufficient information to use the instrument:

QUESTION:

When does the Automatic Calibration take place?

ANSWER:

- a. About 0.2 seconds after the instrument is turned on and at two-minute intervals, thereafter.
- b. About two seconds after  is pressed, or immediately after the instrument is preset by remote control.
- c. Whenever the Center Frequency, Manual frequency, Resolution Bandwidth or IMPEDANCE setting is changed.

(During front-panel operation, the calibration occurs about two seconds after the parameter is changed or immediately if the instrument is in the Manual mode. In Remote, the calibration is performed immediately after the parameter is changed. These parameter-initiated calibrations are inhibited when the Center Frequency or Manual frequency is lower than 150 kHz. Changing the Manual frequency by Continuous Entry does not initiate a calibration.)

- d. The operator can force an Automatic Calibration at any time by entering



AUTOMATIC CALIBRATION

QUESTION:

How does the operator know that a calibration is being performed?

ANSWER:

The "CALIBRATING" message appears on the CRT screen.

QUESTION:

What will happen if the instrument is unable to calibrate properly?

ANSWER:

The beeper will sound and a Calibration Error Code, e.g., "CALIBRATION ERROR 03", will appear on the CRT screen.

(Calibration Error Codes are defined in the 3585 Service Manual.)

QUESTION:



What should the operator do if a calibration error occurs?

ANSWER:

The recommended procedure is as follows:





- a. First, write down the Calibration Error Code and the control settings that are currently being used.

(This information may be of help to the service technician if the condition is intermittent.)

- b. Deactivate  and then store the current instrument state in Register 1 by entering  

- c. Press  :

1. If a Calibration Error Code appears on the screen and/or the beeper sounds, the instrument is either defective or in need of adjustment. Contact a qualified service technician or return the instrument to -hp- for service or repair.

2. If presetting does not produce a Calibration Error Code or "beep", return to the original control settings by entering   . (If the instrument does not calibrate automatically, force a calibration by entering   .)

AUTOMATIC CALIBRATION

If a Calibration Error Code does not appear, the original error was probably the result of a transient or other nonrepeatable phenomenon; in which case, you may continue to use the instrument. Keep in mind, however, that the problem may return. If the calibration error is repeatable, there is definitely something wrong. Again, contact a qualified service technician or return the instrument to -hp-.

QUESTION:

How long does it take to perform an Automatic Calibration?

ANSWER:

The Automatic Calibration time ranges from about 0.1 second to 10 seconds, depending primarily on the Resolution Bandwidth setting. Narrow bandwidths require longer settling times and, therefore, take longer to calibrate.

The initial calibrations that take place after turn on usually take the longest, because there are no previous calibration constants to use as references. Calibration time is also longer during the instrument's warmup cycle since the circuit parameters are continually changing.

QUESTION:

Does a successful Automatic Calibration verify that the 3585 meets its published specifications?

ANSWER:

No. Instrument performance must be tested using the Performance Test procedures outlined in Section IV of this manual. A calibration error is usually a definite indication that something is wrong; but the absence of a calibration error does not begin to verify that the 3585 meets its specifications.

A successful Automatic Calibration is, of course, a good sign that the 3585 is operating properly. However, the corrections that are made during an Automatic Calibration are relative to the instrument's own internal calibration source which could conceivably be out of tolerance. Also, the Automatic Calibration system has no way of testing specified parameters such as noise and distortion levels, spurious responses, scale linearity and frequency response - all of which are important to the overall performance of the instrument.

AUTOMATIC CALIBRATION

QUESTION:

Does Automatic Calibration compensate for full-span frequency response deviations and vertical scale errors?

ANSWER:

No. The Automatic Calibration applies only to the Reference Level amplitude at the Center Frequency or Manual frequency.

The calibration is performed at the Center Frequency or Manual frequency if that frequency is 150 kHz or higher. Otherwise, the calibration is performed at 150 kHz. Since the 3585's response is extremely flat in the 20 Hz to 150 kHz range, the calibration at 150 kHz applies to all Center or Manual frequency settings within that range. For measurements at frequencies other than the Center or Manual frequency and amplitudes other than the Reference Level, the Frequency Response and Amplitude Linearity specifications must be added to the Reference Level and Marker accuracy specifications.

QUESTION:

Is the CRT graticule calibrated?

ANSWER:

No.

For analyzers with lines etched on the face of the CRT, the calibration system has no way of associating any particular displayed point with the grid pattern. The correlation between the frequency and amplitude of a displayed point is determined entirely by the CRT trace alignment which is not specified. To obtain the specified amplitude and frequency, you must make your measurements using the tunable marker rather than the CRT graticule.

For analyzers with a displayed grid pattern, the circuits generating the grid display are not referenced to those creating the trace pattern. Again, it is a matter of alignment which is not specified.

QUESTION:

Is the High-Impedance (1 M Ω) input calibrated?

ANSWER:

Not completely. The Automatic Calibration is performed through the Terminated input channel, regardless of which input is being used. The High-Impedance input channel itself is not calibrated, but all circuitry following the input channel is calibrated in the normal manner. Since the calibration is performed through the Terminated input channel, the Terminated input provides higher amplitude accuracy than the High-Impedance input.

QUESTION:

Can the operating parameters be changed during an Automatic Calibration cycle?

ANSWER:

Yes; but only from the front panel. Remote entries are inhibited during Automatic Calibrations. Changing the Center Frequency, Manual frequency, Resolution Bandwidth or IMPEDANCE setting will abort an Automatic Calibration cycle that is currently in progress. A new calibration will be initiated about two seconds after the parameter is changed.

QUESTION:

Does an Automatic Calibration inhibit measurements and interrupt the frequency sweep?

ANSWER:





Yes. During an Automatic Calibration cycle, all measurements and all instrument functions such as Auto. Range are inhibited and the frequency sweep is stopped. However, the Auto. Cal. will not interrupt a frequency sweep unless the Sweep Time is 22 seconds or longer or the calibration is initiated by a change in parameters. If a Noise-Level calculation is in progress when a normal Auto. Cal. cycle is initiated, the calibration is held-off until the Noise Level measurement is complete.

QUESTION:

How can the Automatic Calibration be disabled?

ANSWER:

Automatic Calibration can be disabled by pressing (or remotely entering)

  .It can be reenabled by pressing  or entering   .

(When the Auto. Cal. is disabled, the "CALIBRATION DISABLED" message is displayed in place of the "CALIBRATING" message, each time a calibration cycle would normally occur.)

AUTOMATIC CALIBRATION

QUESTION:

When should the Automatic Calibration be disabled?

ANSWER:

There are three cases where it may be necessary or desirable to deactivate the Automatic Calibration system:

- a. During nonrepeatable real-time measurements where an Auto. Cal. interrupt would cause vital information to be lost.
- b. To save time when remotely entering a string of parameters that would cause successive calibrations to occur, it is generally preferable to deactivate the Auto. Cal., enter the parameter string and then reactivate the Auto. Cal. to force a calibration.
- c. When making X-Y recordings using the rear panel VIDEO OUTPUT or IF OUTPUT. (These outputs go to their full-scale levels during calibrations.)

The 3585's accuracy specifications apply for only two minutes after an Automatic Calibration cycle. If it is necessary to operate with the calibration disabled, always force a calibration before deactivating Auto. Cal. and try to maintain a two-minute calibration interval during your measurement.

REAR-PANEL FEATURES

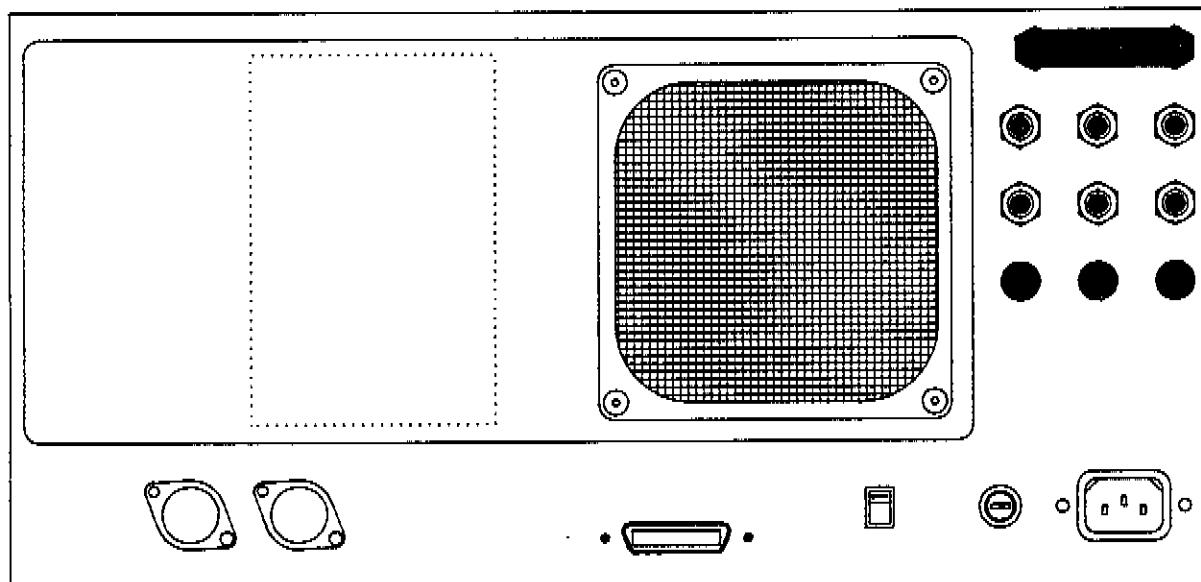

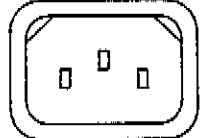
~LINE
 AC Line Input Connector: Accepts power cord supplied with instrument.

~ FUSE
 AC Line Fuseholder.

~ VOLTAGE
 SELECTOR
 Line Voltage Selector Switch.

HP-IB
 HP-IB Connector: Used to interface the instrument with the Hewlett-Packard Interface Bus (HP-IB) for remote operation. Remote operation is described in Section III, Part 2.

OVEN REF OUT
 Supplies a $10 \text{ MHz} \pm 1 \times 10^{-7}$ per month sinusoidal frequency reference from an internal crystal oscillator, located in a temperature-controlled oven. The output is ac coupled and the output impedance is 50 ohms. The nominal output level is +10 dBm/50 ohms. The output is disabled during the oven's warmup cycle. To use the internal Oven Reference, this output must be connected to the EXT REF IN jack.

REAR PANEL



This input allows the 3585's master oscillator to be phase locked to the internal Oven Reference or an external frequency standard. The input is ac coupled and the input impedance is 50 ohms. The frequency of the reference signal applied to this input must be 10 MHz or any subharmonic down to 1 MHz (± 5 ppm), and the amplitude must be within the range of 0 dBm to + 15 dBm (50 ohms). Dynamic range performance will be degraded unless the phase noise and spurious content of the reference signal is ≤ -110 dBc (1 Hz) referred to 10 MHz at a 20 Hz to 1 kHz offset.

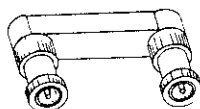

To use the internal Oven Reference, connect this BNC-to-BNC jumper between the OVEN REF OUT connector and the EXTERNAL REF IN connector.



Supplies a 10 MHz square wave that is phase locked to the reference frequency applied to the EXTERNAL REF IN connector. When the internal Oven Reference is used, the frequency accuracy is $10 \text{ MHz} \pm 1 \times 10^{-7}$ per month. The output is transformer coupled, the output impedance is 50 ohms and the nominal output level is + 20 dBm/50 ohms. This reference output can be used to phase lock an external signal source or another analyzer to the 3585's frequency reference.



This output is taken from a voltage divider which connects directly to the output of the 3585's final IF filter. The output signal is a 350 kHz (nominal) sine wave, whose amplitude is linearly proportional to the amplitude of the input-signal component to which the 3585 is tuned. The output is ac coupled and the output impedance is approximately 450 ohms. When the signal amplitude is equal to the Reference Level and the Reference Level is + 10 dB to - 56 dB relative to the Range setting, the full-scale IF output level ranges from approximately 247 mV rms (- 12.0 dBV) to 157 mV rms (- 16.0 dBV), depending on the internal IF gain setting. The IF gain settability is limited to 4 dB steps and, because of the variable offsets that are introduced by the Automatic Calibration system, the IF gain and full-scale IF output level is not always the same for a given Reference Level setting. The full-scale IF output level will vary (over a 4 dB range) as a function of Reference Level, Range, Impedance and Resolution Bandwidth. Before using the IF Output in a critical measurement application, select the required operating parameters, force an Automatic Calibration and then *measure* the full-scale IF output level.

The IF Output can be used to drive an external detector (e.g., a voltmeter or wave analyzer) to obtain a linear video output which, in turn, can be used for audio monitoring in radio surveillance applications, or applied to the vertical input of a storage oscilloscope or X-Y recorder for application requiring a linear amplitude scale. The IF Output can also be connected to a true rms voltmeter for making rms noise-level measurements.

(The 3585's equivalent noise bandwidth is approximately 1.2 times the 3 dB bandwidth established by the Resolution Bandwidth setting. The 3 dB bandwidth has a specified tolerance of $\pm 20\%$ and must, therefore, be measured to obtain accurate results.)

NOTES

1. The IF Output goes to its full-scale level (270 mV to 190 mV) during Automatic Calibration cycles.
2. The Video Output level is +10 Vdc during Automatic calibrations.
3. If the video amplitude is more than ten divisions below the Reference Level, the Video Output will go negative. Maximum negative output levels are typically as follows:

<i>dB/DIV</i>	<i>Maximum Negative Output</i>
10	- 0.5 Vdc
5	- 10.5 Vdc
2 or 1	- 13.5 Vdc





Supplies a dc output voltage (prior to peak detection and digitizing) that is proportional to the "A" Trace video amplitude on the CRT screen. The Video Output is scaled to one volt per division, and the nominal output level ranges from +10.0 Vdc at the Reference Level to 0.0 Vdc at ten divisions below the Reference Level. The output resistance is 1 kilohm, nominal. The output is diode clamped to ±15 Vdc and is internally fused at 62 mA, N.B.

The Video Output can be applied to an external analog-to-digital converter or digital voltmeter to obtain higher amplitude resolution than is provided by the CRT readouts. When connected to a high-impedance headset or amplifier through a coupling capacitor, it can be used to monitor the audio on an amplitude-modulated carrier. (Since the video amplitude is logarithmic, the audio obtained from the Video Output is quite distorted although intelligible enough for some monitoring purposes.

Display Outputs

The DISPLAY outputs allow all of the CRT information to be displayed on an auxiliary CRT monitor.

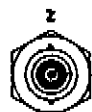
	Output Level (nominal)	Output Resistance (nominal)	Protection
 	0V to +1 Vdc	1 kilohm	diode clamped to ±15 Vdc; internally fused at 62 mA, N.B.
	Beam Off: -0.5 Vdc* Beam On: +4.3 Vdc	47 ohms	diode clamped to ground and +5 Vdc; internally fused at 62 mA, N.B.

*The "Z" output is strictly a beam off/on function; there is no intensity modulation.

CHAPTER 2

BASIC OPERATING PROCEDURES

This chapter describes a basic six-step procedure for making swept signal-analysis measurements using the 3585 . Additional topics include:

Special Measurement Techniques
Improving Noise-Free And Distortion-Free Dynamic Range
Amplitude Frequency-Response (Network Analysis) Measurements Using the Tracking Generator

SIX STEP OPERATING PROCEDURE

Most signal-analysis measurements can be made in six easy steps:

1. Press .
2. Select the desired input and connect the signal source.
3. Adjust the frequency parameters to obtain the desired frequency display range.
4. If necessary, adjust the Resolution Bandwidth and/or Video Bandwidth parameters to obtain the required sensitivity, resolution and display smoothing.
5. Select amplitude display units and, if necessary, adjust the Reference Level.
6. Measure frequency and amplitude of on-screen responses using the tunable Marker.

The detailed aspects of each step are given in the following paragraphs.

STEP 1: Press



The  function provides a convenient starting point for nearly all measurements. Presetting forces all parameters to their turn-on states and initiates an Automatic Calibration cycle. The preset operation does not erase portions of memory in which the "B" Trace, control settings and calibration constants are stored.

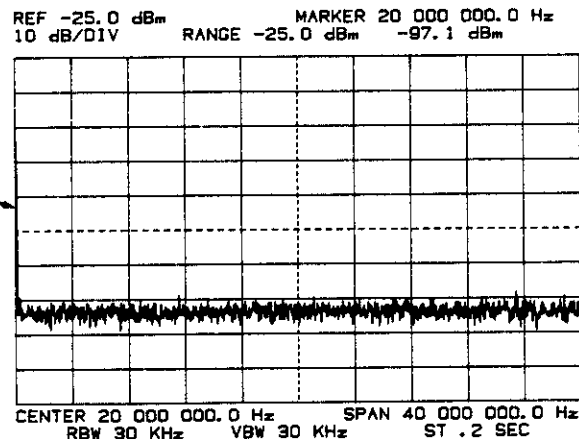

With full span, zero response may mask low-frequency signals.





CRT Display After  (no input signal)

 **STEP 1**

In the preset state, the  and  functions are activated and the 50-ohm Terminated input is selected. Both Range and Reference Level are initially preset to +30 dBm. (With no signal applied to the input, the instrument automatically downranges to -25 dBm.) With  activated, the Reference Level is coupled to Range and, therefore, remains equal to the Range setting.

Presetting establishes a full 0 Hz to 40 MHz Frequency Span with a Center Frequency of 20 MHz and a 0.2-second continuous sweep. This provides a broad "instant" view of the entire spectrum which, in most cases, will allow you to quickly locate and "zoom-in" on the major signals of interest. The peak detection system that is used in the 3585 insures that the peak of any response that protrudes through the noise is retained and displayed at a point on the CRT trace. Therefore, if a response is present anywhere in the span, you will be able to see it unless it is masked by the analyzer's zero response which appears at 0 Hz. If the signal that you wish to measure is lower than about 300 kHz, the full span may not provide the resolution needed to separate it from the zero response. This situation can be quickly remedied by simply decrementing the Stop Frequency (with  ) until the signal becomes distinguishable.



The Resolution Bandwidth and Video Bandwidth parameters are preset to 30 kHz and the Sweep Time is preset to 0.2 seconds. These Bandwidth and Sweep Time settings are the preferred or "optimum" settings for the full 40 MHz span. Once these settings are established, the  function (also activated by ) will automatically set the Resolution Bandwidth and Video Bandwidth to maintain proportional resolution and display smoothing as the Frequency Span is narrowed. It will also automatically adjust the Sweep Time according to the Frequency Span and Bandwidth settings to maintain the maximum-calibrated sweep rate. This convenient coupling arrangement allows the operator to initially concentrate on adjusting the frequency parameters to obtain the desired frequency display range. Once the frequency parameters have been set, the Bandwidth and Sweep Time parameters can be individually adjusted to meet specific requirements and, where necessary, the coupling can be deactivated. The UNCAL indicator, located in the RBW, VBW, ST control block, lights whenever the manually-selected sweep rate is too fast to maintain calibration.

If you require specific Bandwidth and Sweep Time settings, you may, of course, select them at the onset of the measurement. In most cases, however, it is best to start out using the automatic settings and then make any fine adjustments needed to obtain the required results.

STEP 2: Select the desired input and connect the signal source.

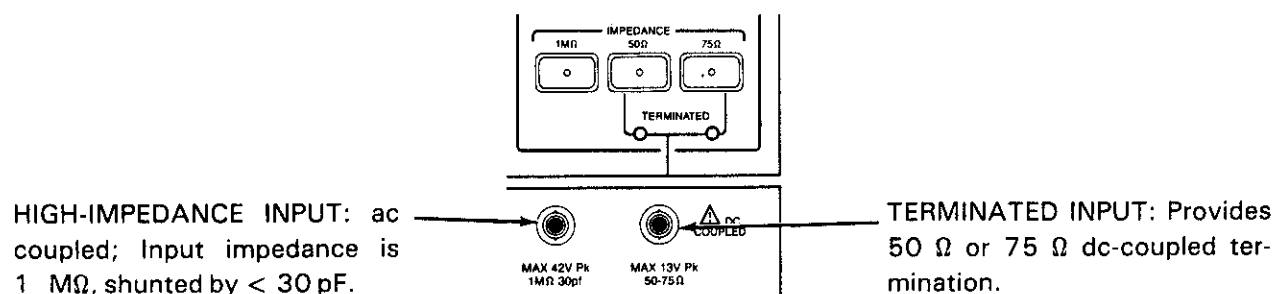
Input Selection







To use the Terminated input, select the desired terminating impedance by pressing the  or  IMPEDANCE key. ( automatically activates the Terminated input and selects the 50 ohm termination.) The IMPEDANCE key will light to indicate that the Terminated input is activated; the TERMINATED light, directly below the IMPEDANCE key, will light to indicate that the input is terminated. The TERMINATED light also indicates the impedance to which the instrument is automatically calibrated for dBm measurements (i.e., dBm/50 Ω or dBm/75 Ω).

To use the High-Impedance input:

- a. Select the desired calibration impedance by pressing  OR .

(The calibration impedance is the impedance to which the instrument is automatically calibrated for dBm measurements; i.e., dBm/50 Ω or dBm/75 Ω. For measurements in dBV or volts, the IMPEDANCE setting is arbitrary.)

- b. Activate the High-Impedance input by pressing .

The  key will light to indicate that the High-Impedance input is activated. The  or  key will go out but the 50 Ω or 75 Ω TERMINATED light will stay on to indicate the calibration impedance and also to indicate that the Terminated input is terminated with a 50 Ω or 75 Ω dummy load.

STEP 2



Connect Signal Source





The Terminated input is dc coupled. Peak (combined ac/dc) input levels exceeding ± 13 volts will activate the protection circuit but may still damage the input circuitry.*

RF input levels exceeding ± 5.25 V peak at the High-Impedance input may damage the input circuitry (see Chapter 4 for details). The peak (combined ac/dc) input level applied to the High-Impedance input must not exceed ± 42 volts.

Connect The Signal Source To The Selected Input

With  activated, the 3585 will automatically select the proper Range according to the amplitude of the ac input signal. With  also activated, the Reference Level will automatically change in 5 dB increments along with the Range setting. Since the Reference Level was initially set equal to the Range with , it will remain equal to the Range until it is manually changed. Unless the input-signal level is well below -25 dBm, this will automatically place the largest input-signal component at or near the top of the screen.

With  activated, Reference Level automatically set equal to RANGE. Largest input-signal response at or near top of screen.  sets RANGE automatically according to input-signal amplitude.

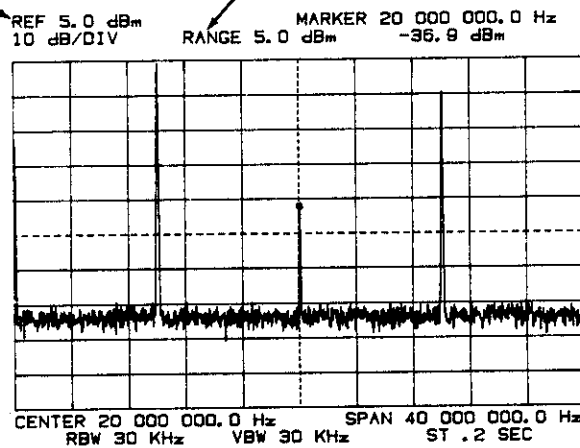

Input Signal Applied

*When the Protection circuit is activated, the Terminated input opens and the 50 Ω or 75 Ω TERMINATED light goes out. To reset the Protection Circuit, disconnect the signal source and then press any of the IMPEDANCE keys.

STEP 3: Adjust the frequency parameters to obtain the desired frequency display range.

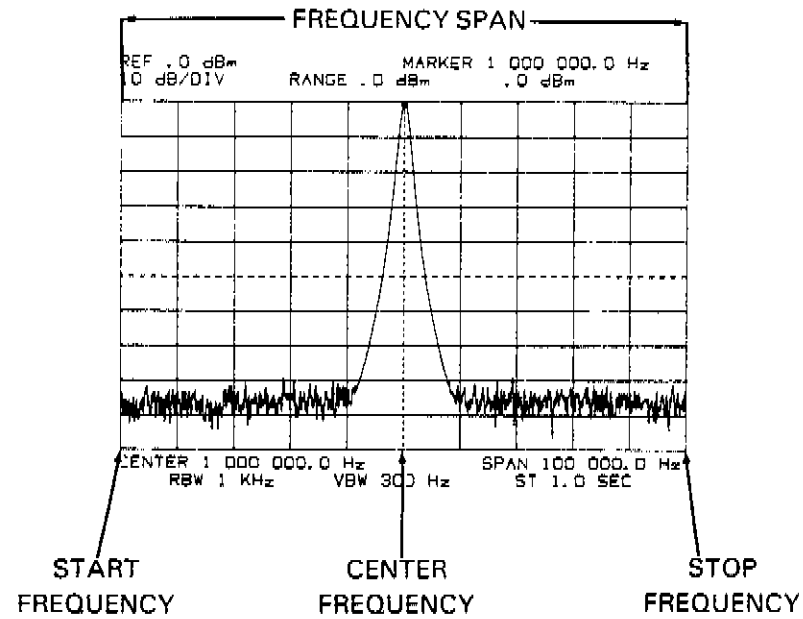

There are two basic methods for setting the frequency display range:

1. Enter Center Frequency and Frequency Span
- OR
2. Enter Start Frequency and Stop Frequency

STEP 3

Center Frequency Entries



Entering Center Frequency and Frequency Span

Center Frequency and Frequency Span entries are generally used to display and measure a specific component within the input-signal spectrum or to examine a group of closely spaced signals such as a modulated carrier and its side frequencies; IM distortion products, noise sidebands, etc.

Center Frequency



The first step is to set the Center Frequency so that the major signal of interest is in the center of the screen. This can be done using any of three entry methods:

1. Marker/Counter Entry:

Marker Entry: With  activated, set the Marker to the peak of the signal of interest with . Then, press . (This sets the Center Frequency equal to the Marker frequency.)

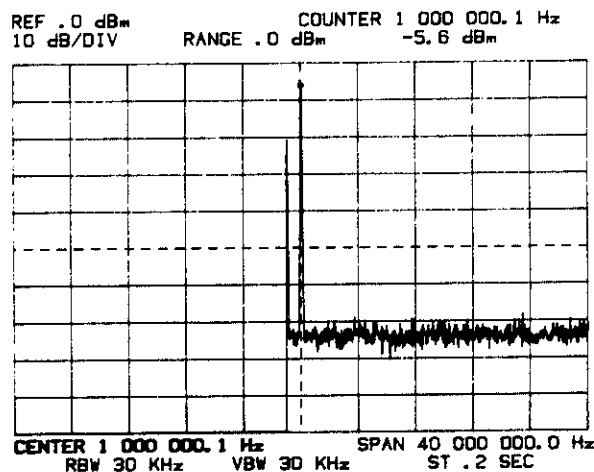
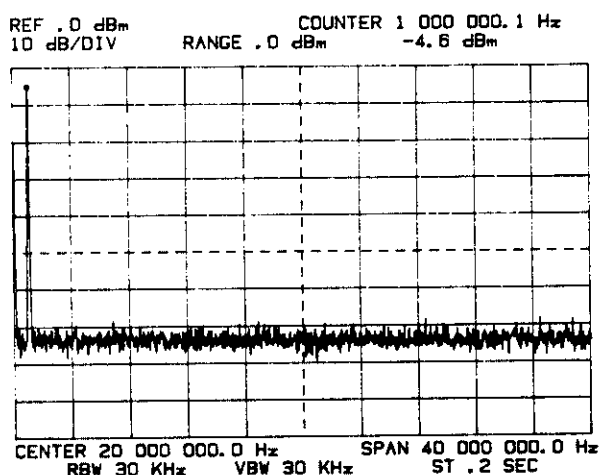
Counter Entry: Because of the limited frequency resolution and accuracy of the Marker, a response that has been moved to the center of the screen by Marker Entry may move off center as the Frequency Span is narrowed. This effect can be avoided by using the COUNTER function:





- a. With  and  activated, set the Marker at least 20 dB above the noise floor on the skirt (or peak) of the response that is to be moved to the center of the screen. Allow time for the "COUNTER" reading to appear in the top-right corner of the screen.

- b. Press .

(This sets the Center Frequency equal to the "COUNTER" frequency.)

(The "COUNTER" reading indicates the true signal frequency at the *peak* of the response on which the Marker is positioned.)

2. Continuous Entry



Activate  ; then move signal of interest to center of screen with  . Continuous Entry resolution is 0.1% of Frequency Span; i.e., 40 kHz for a 40 MHz Span.

3. Numeric Entry:



Center Frequency is settable within the range of 0 Hz to 40.1 MHz with 0.1 Hz resolution.

NOTES

1. If the frequency of the signal to be measured is lower than about 300 kHz, the full Span will not provide the resolution needed to separate that signal from the zero response on the CRT screen. To improve the resolution, simply decrement the Stop Frequency ( ) until the signal becomes distinguishable.

2. With a 40 MHz Frequency Span, a Center Frequency change greater than -0.1 Hz will set the Start Frequency lower than 0 Hz; and a change greater than $+100$ kHz will set the Stop Frequency higher than 40.1 MHz. When the Start or Stop frequency limit is exceeded the "out of range" portion of the CRT trace is blanked and the "SWEEP SPAN LIMITED" message appears on the screen. This effect can be ignored since the limited sweep span condition will be corrected when the Frequency Span is narrowed in the following step.

STEP 3
Frequency Span Entries

Frequency Span

Once the signal has been moved to the center of the screen, the Frequency Span can be narrowed to display the frequency range of interest above and below that signal. As the Frequency Span is narrowed, the Resolution Bandwidth and Video Bandwidth settings are automatically narrowed to maintain proportional resolution and noise averaging; the Sweep Time is automatically adjusted to maintain the maximum-calibrated sweep rate.



NOTE

Changing the Frequency Span changes the displayed frequency range symmetrically about the Center Frequency and, therefore, does not affect the Center Frequency setting. Frequency Span refers to the total displayed frequency range; divide by 10 to determine Frequency Span per division.

The Frequency Span can be narrowed using either of two methods:

1. Step Entry:   

Steps change the Frequency Span to the next value in a 1, 2, 5, 10 sequence.

2. Numeric Entry:  

Frequency Span is settable within the range of 0 Hz to 40.1 MHz with 0.1 Hz resolution.

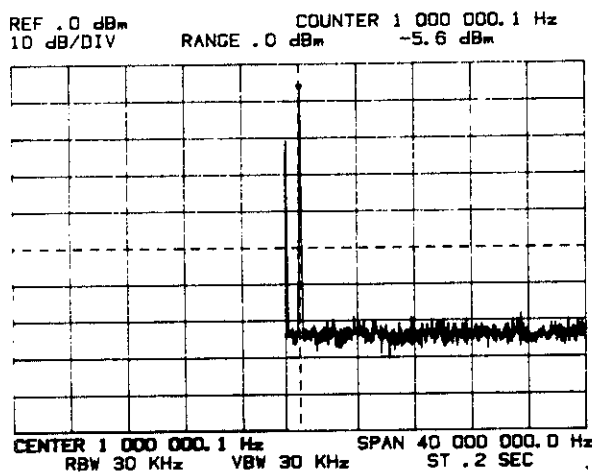

a. Signal in center of screen with limited sweep span.

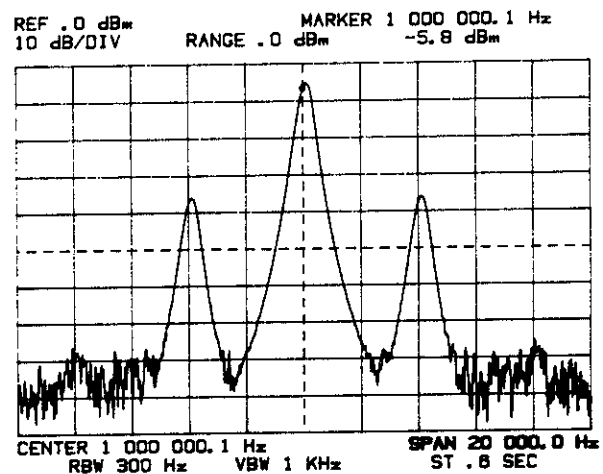



b. Frequency Span narrowed about Center frequency to obtain required resolution. RBW, VBW and ST parameters are set automatically.

(Observe that the peak of the response is skewed slightly off center. This frequency skew, caused by sweep dynamics, can be minimized by increasing the Sweep Time.)

Entering Start and Stop Frequencies

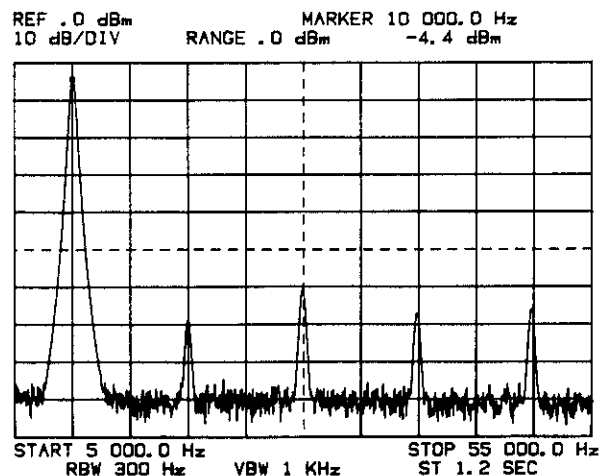
Start and Stop frequency entries provide a convenient way to display a specific range of frequencies. For example, a Start Frequency of 5 kHz and a Stop Frequency of 55 kHz can be used to fully display the fundamental through fifth harmonics of a 10 kHz signal:



Prefacing the Start Frequency or Stop Frequency automatically displays the Start and Stop frequencies in place of Center and Span. The Start and Stop frequencies will continue to be displayed until Center Frequency, Frequency Span or CF Step Size is prefaced; Center Frequency is changed by Marker or Continuous Entry; a Manual frequency is entered or  or  is pressed.



Changing the Start Frequency and/or Stop Frequency changes both the Center Frequency and the Frequency Span. The 3585 will automatically calibrate at the Center Frequency and will automatically set the Resolution Bandwidth, Video Bandwidth and Sweep Time according to the Frequency Span.*

Start and Stop frequencies can be entered three ways:

1. Numeric Entry:  OR  

The Start Frequency and Stop Frequency parameters are settable within the range of 0 Hz to 40.1 MHz with 0.1 Hz resolution.

2. Step Entry:  OR   

Steps change the Start Frequency or Stop Frequency such that the Frequency Span is at the next value in a 1, 2, 5, 10 sequence.

3. Offset Entry:

Offset entries allow you to quickly set Start and Stop frequencies or "zoom in" on a signal of interest using the Marker.



*If the Center Frequency is lower than 150 kHz, the calibration is performed at 150 kHz.

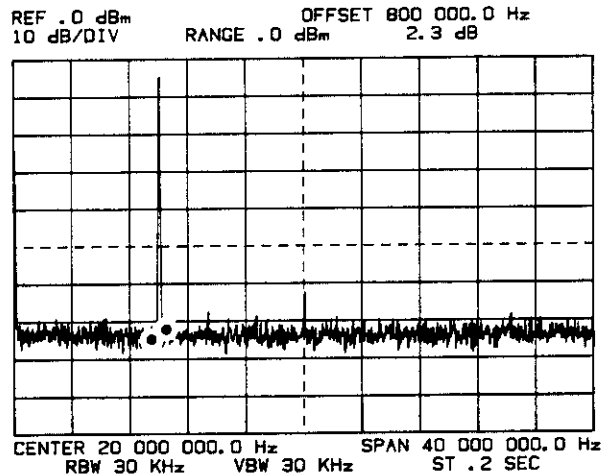
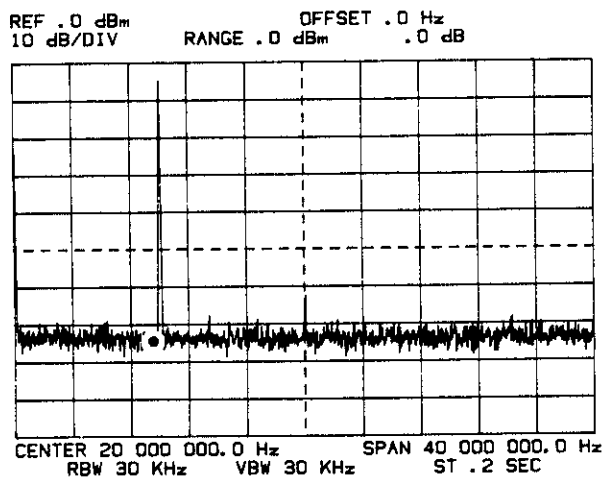

STEP 3
Start/Stop Entries

Example Offset Entry*



a. Set the Marker to the desired Start (or Stop)

Frequency with   .

Activate  and then press  .

b. Set the Marker to the desired Stop (or Start)

Frequency with  .

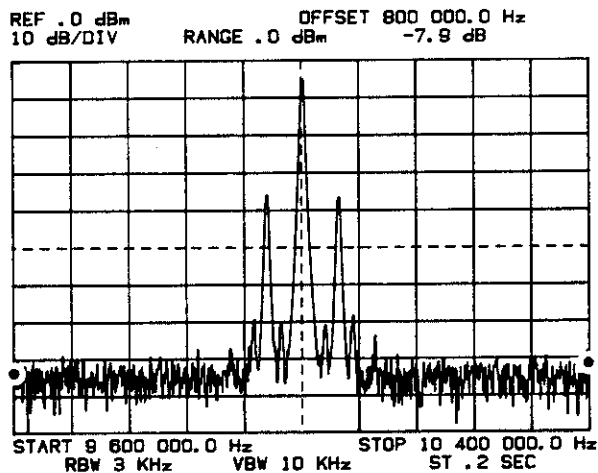



c. Press  .

(This sets the Start and Stop frequencies equal to the left and right Marker frequencies, respectively; and sets the Frequency Span equal to the "OFFSET" frequency displayed in top-right corner of screen. Note that the Markers can be placed at either end of the Span. Pressing  automatically displays "START" and "STOP" in place of "CENTER" and "SPAN".)

*After entering Start and Stop frequencies with Offset to Span, deactivate Offset so that the Marker readout will indicate absolute frequency and amplitude.

STEP 4: If necessary, adjust the Resolution Bandwidth (RBW) and/or Video Bandwidth (VBW) parameters to obtain the required sensitivity, frequency resolution and display smoothing.

Resolution Bandwidth

The Resolution Bandwidth settings that are selected automatically generally provide adequate resolution and a good aspect ratio. However, the automatic RBW settings may not provide the noise-free dynamic range required for your specific measurement or the resolution needed to separate closely spaced signals within the selected frequency span. To improve the sensitivity and frequency resolution, simply narrow the RBW one or two steps by pressing  . (Narrowing the RBW one step reduces the noise level by about 4.5 dB.) When the RBW is narrowed, the Sweep Time will automatically increase to maintain absolute calibration.

NOTE

With  activated, VBW is coupled to RBW. Therefore, a change in the RBW setting will also change the VBW setting. Changing the VBW does not affect the RBW.

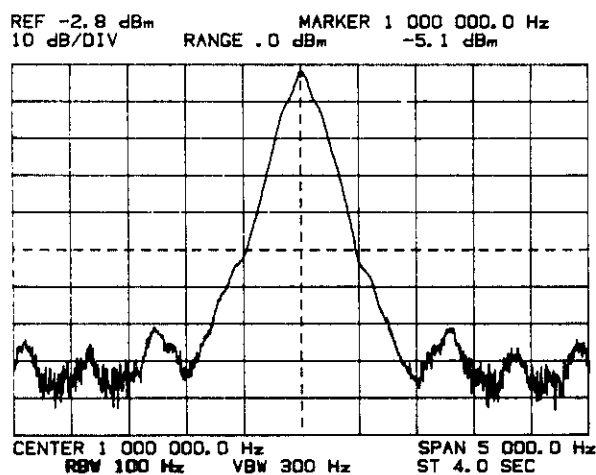

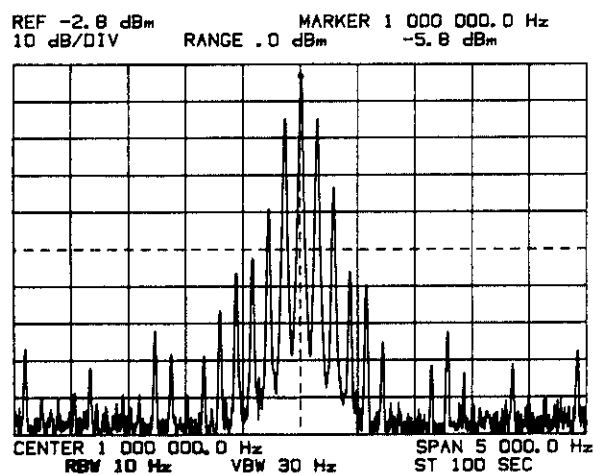

Closely spaced signals in 5 kHz Span unresolved with 100 Hz RBW (automatically selected).



Signals resolved by narrowing RBW to 10 Hz (two steps); VBW tracks RBW; ST increases to 100 seconds to maintain absolute calibration.

STEP 4
Adjust VBW

Video Bandwidth

The Video Bandwidth (VBW) settings that are selected automatically provide a minimum amount of video filtering. To measure low-level signals that are near the noise floor, it is generally necessary to narrow the VBW at least one or two steps below the automatic setting. This can be done by pressing   or by Numeric Entry. The most effective video filtering is obtained when the VBW is 10% to 1% of the Resolution Bandwidth. Narrowing the VBW automatically increases the Sweep Time.

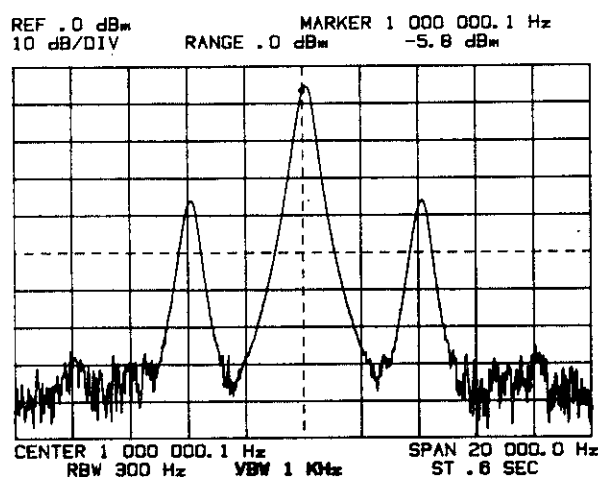

Low level harmonics masked by noise with 1 kHz VBW (automatically selected).

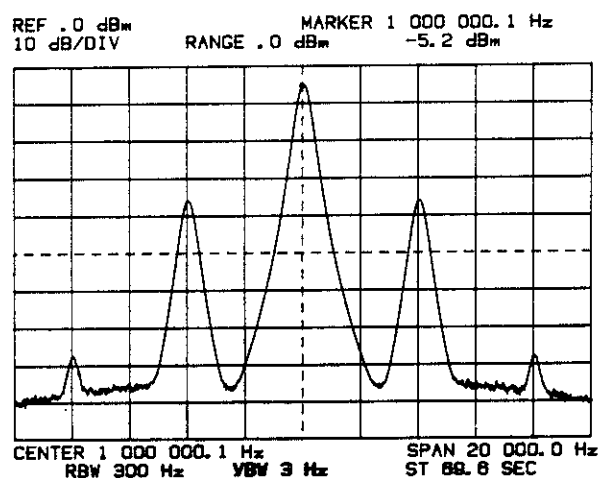

Narrowing VBW to 3 Hz (1% of RBW) reduces the noise variations, making it easy to see the low-level harmonics. (This also increased the Sweep Time and eliminated the frequency skew.)

NOTES

1. To measure impulse noise, the Video Bandwidth must be equal to or wider than the Resolution Bandwidth.
2. When measuring random noise spectral density using the 3585 NOISE LVL function, the Video Bandwidth setting is arbitrary. (The 3585 internally selects the 100 Hz VBW during its noise measurement routine.)
3. To measure the rms value of the average noise appearing on the CRT, the VBW must be narrowed to 1% of the Resolution Bandwidth (or narrower). Add +2.5 dB to the displayed average noise level to compensate for the instrument's log converter and average-responding detector.

STEP 5: Select amplitude display units and, if necessary, adjust the Reference Level.

Select Amplitude Display Units

At this point, the Reference Level, Range and Marker amplitude are displayed in dBm/50 ohms or dBm/75 ohms, depending on the calibration impedance you selected in Step 1. If you wish to make measurements in dBV or rms volts:

1. Convert the readouts to dBV by pressing REFERENCE LEVEL M1: dBV mV.
2. Convert the readouts to rms volts by pressing REF LEVEL VOL1.

NOTES

1. Converting the Reference Level readout to volts does not redefine the vertical scale. The 3585 vertical scale is always in logarithmic units of "dB" relative to the Reference Level; the 3585 does not have a linear scale. Reference Level voltage settability is limited to 0.1 dB (approximately 1%).

2. Pressing REFERENCE LEVEL returns the readouts to "dBm" or "dBV".

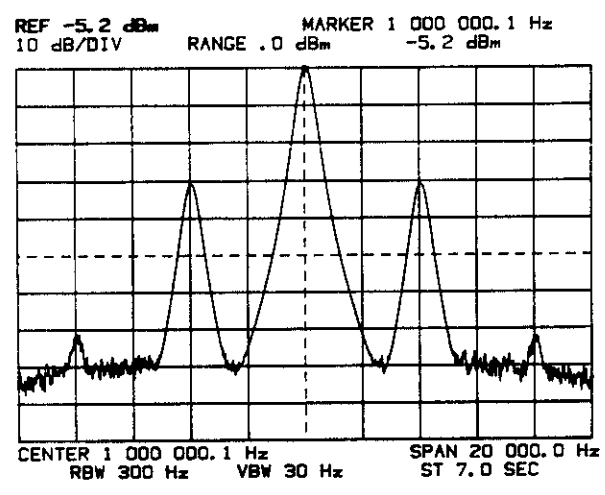

Displays REF, RANGE and Marker amplitude in "dBm" (50 Ω or 75 Ω).

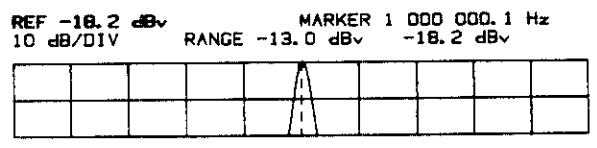

Displays REF, RANGE and Marker amplitude in "dBV" (1 V rms = 0 dBV).

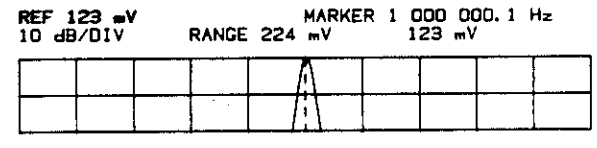

Displays REF, RANGE and Marker amplitude in rms volts.

STEP 5
Adjust Reference Level

Reference Level Adjustment

The 3585 Reference Level is settable from 100 dB below the RANGE setting to 10 dB above the RANGE setting (0.1 dB resolution). The ability to adjust the Reference Level makes it possible to move any response within the 110 dB adjustment range to the top of the screen for measurement. There are two major reasons for doing this:

1. The amplitude accuracy at the top of the screen is substantially better than it is at lower levels.
2. Signals at the top of the screen can be expanded vertically by reducing the Vertical Scale (dB/DIV) setting. Vertical expansion improves the amplitude resolution and accuracy.

Also, with a narrow Resolution Bandwidth the noise level may be so low that it is below the bottom line of the CRT graticule. By lowering the Reference Level, the noise floor and any low-level signals can be moved onto the screen for measurement.

For general-purpose measurements where optimum amplitude accuracy is not required, the Reference Level is normally adjusted so that the peak of the largest response to be measured is at the top of the screen. This minimizes scale errors within the measurement range being used and provides maximum vertical display range. For applications requiring high amplitude accuracy, the individual signals of interest are moved to the center of the screen (by adjusting the Center Frequency) and are then moved to the top of the screen by adjusting the Reference Level. The most accurate point on the CRT display is the Reference Level at the Center Frequency or Manual frequency (i.e., the frequency at which the Automatic Calibration is performed).

NOTES



Points on the CRT trace will not respond to a change in Reference Level (or any other parameter) until they are updated by the frequency sweep. For this reason, it may be beneficial to adjust the Reference Level before making RBW/VBW adjustments that will increase the Sweep Time.

Lowering the Reference Level (rotating  CCW) moves low-level signals closer to the top of the screen.



The Reference Level can be set equal to the RANGE at any time by simply turning  off and then back on.

The Reference Level can be adjusted using any of four different techniques:

1. Continuous Entry:

Activate  and move the signal of interest to the top of the screen using the Continuous Entry control . Continuous Entry resolution is 0.1 dB.

2. Marker Entry:

With  activated, set the tunable Marker to the peak of the response that is to be moved to the top of the screen; and then press . (This sets the Reference Level equal to the Marker amplitude.)

3. Step Entry:  OR   

Steps change Reference Level by 5% of amplitude display range; i.e., 5 dB, 2.5 dB, 1 dB or 0.5 dB, depending on Vertical Scale setting.

4. Numeric Entry:   OR  

Settability is 100 dB below Range to 10 dB above Range, 0.1 dB resolution.

Vertical Expansion

Reducing the Vertical Scale (dB/DIV) setting expands the vertical scale downward from the Reference Level. Vertical expansion improves the amplitude resolution on the CRT trace and also improves the Marker amplitude resolution and accuracy.

The 3585A has four Vertical Scale settings; 10 dB, 5 dB, 2 dB and 1 dB per division. With ten vertical divisions, these settings provide a display range of 100 dB, 50 dB, 20 dB or 10 dB, respectively:



Vertical Scale	Display Range	Marker Amplitude Resolution	Reference Level Accuracy Degradation*
10 dB/DIV	100 dB	0.1 dB	± 0.1 dB
5 dB/DIV	50 dB	0.05 dB	± 0.1 dB
2 dB/DIV	20 dB	0.02 dB	none
1 dB/DIV	10 dB	0.01 dB	none

*When the Marker is at the top of the screen, the Marker amplitude accuracy is equal to the Reference Level accuracy. When using the 10 dB/DIV or 5 dB/DIV Vertical Scale setting, add ± 0.1 dB to the Reference Level (and Marker) amplitude accuracy specification.

The Vertical Scale setting can be changed two ways:

1. Step Entry:   

Steps select next available setting.

2. Numeric Entry:  

Enter specific setting. (Entries that select unavailable settings are not accepted.)

STEP 5

Vertical Expansion

Here is a technique for moving a signal of interest to the top of the screen and expanding it vertically:

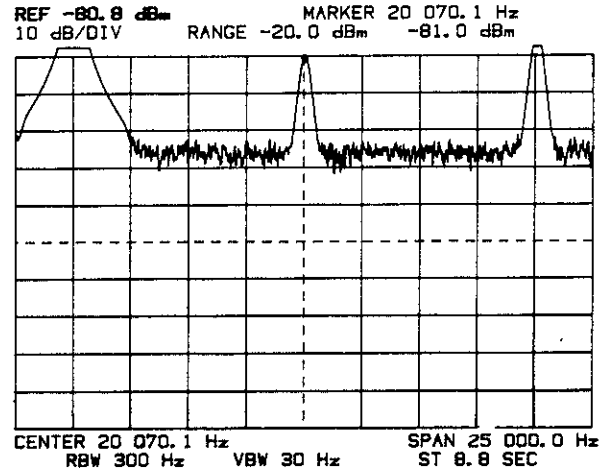
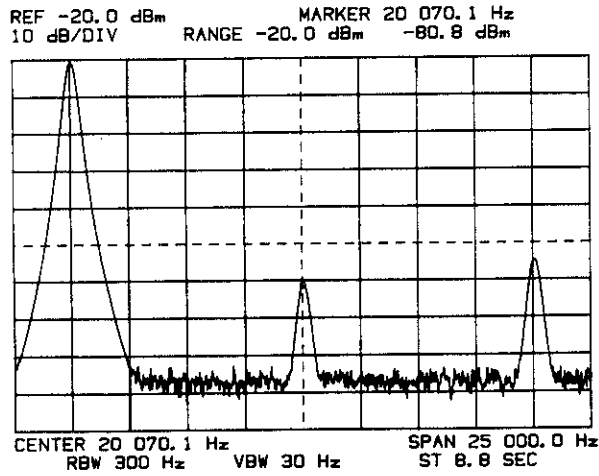

a. Set Marker to peak of signal with 

b. Move signal to top of screen by pressing



(This could also be done by Continuous, Step or Numeric Entry.)

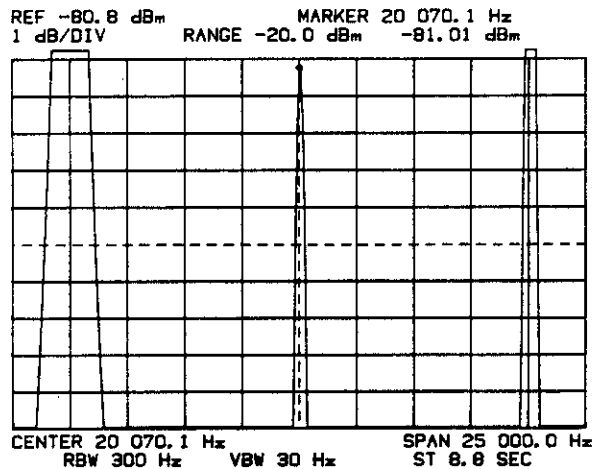

c. Reduce the Vertical Scale with   or by Numeric Entry.



(Observe that "MARKER" amplitude readout now has two fractional digits. With 1 dB/DIV, Marker amplitude resolution is 0.01 dB.)

NOTE

Signals that are above the Reference Level will overdrive the display as shown. This will not damage the instrument nor degrade its performance.

STEP 6: Measure frequency and amplitude of on-screen responses using the tunable Marker.

Absolute Measurements

With  activated, set the tunable Marker to the point of interest on the CRT trace using the Continuous Entry control . Read the absolute frequency and amplitude directly from the "MARKER" readout in the upper right-hand corner of the screen.

Precise Frequency Measurement Using The Counter

The Marker's frequency resolution and accuracy is limited by the point-by-point display and sweep dynamics. To precisely measure the frequency of a signal that is producing a response, use the COUNTER function:

1. Set the Marker at least 20 dB above the noise floor on the skirt (or peak) of the response to be measured.
2. Activate ; allow time for the COUNTER reading to appear in the upper right-hand corner of the CRT screen. (The COUNTER reading does not appear until the frequency sweep passes through the Marker frequency.)
3. The COUNTER reading indicates the true signal frequency at the *peak* of the response on which the Marker is positioned. The Marker does not need to be at the peak of the response.

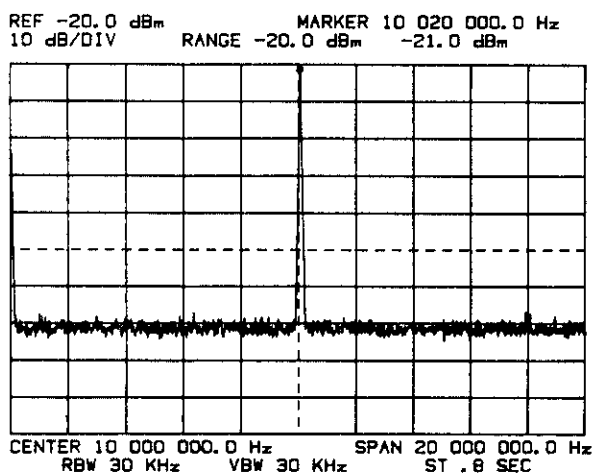

a. Peak of 10.035 MHz response displayed at 10.02 MHz point on CRT trace as indicated by "MARKER" frequency readout.

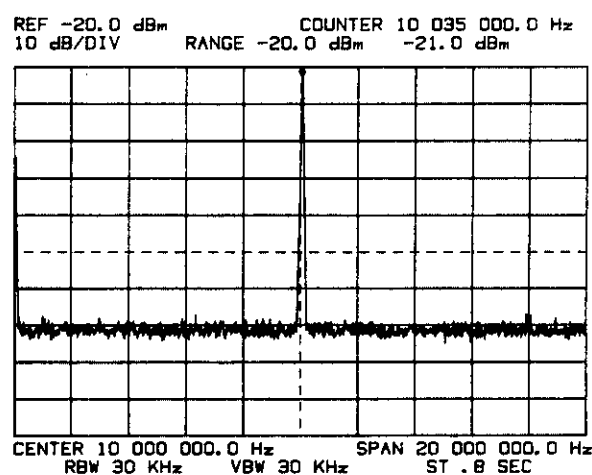

b. "COUNTER" frequency readout indicates true frequency at peak of response.

STEP 6





Optimizing Amplitude Accuracy

NOTES

1. The "COUNTER" amplitude readout indicates the Marker's amplitude on the CRT trace which is not necessarily the amplitude at the peak of the response. To measure the peak amplitude of a response, the Marker must be set to the peak of that response.
2. The counting operation, performed each time the frequency sweep passes through the marker frequency, will sometimes produce dynamic "glitching" on the skirt of the response whose frequency is being counted. This does not affect the frequency or amplitude accuracy.
3. To obtain accurate, stable Counter readings, the Marker must be at least 20 dB above the noise floor and at least 20 dB above any unresolved signal that is inside the IF filter skirts.
4. While the Marker is being tuned, the Counter is inhibited and the readout displays the "MARKER" frequency and amplitude. When the Marker becomes stationary, the "COUNTER" reading reappears after the frequency sweep passes through the Marker frequency.

Optimizing Amplitude Accuracy

To measure the absolute amplitude of a response with high accuracy, perform the following steps:





- a. Move the response to the center of the screen by adjusting the Center Frequency.
- b. Increase the Sweep Time *two* steps by pressing    .
- c. Move the Response to the top of the screen by adjusting the Reference Level.
- d. Reduce the Vertical Scale to 1 dB/DIV with   or by Numeric Entry.
- e. Set the Marker to the peak of the response and observe the amplitude reading.

Relative Frequency And Amplitude Measurements

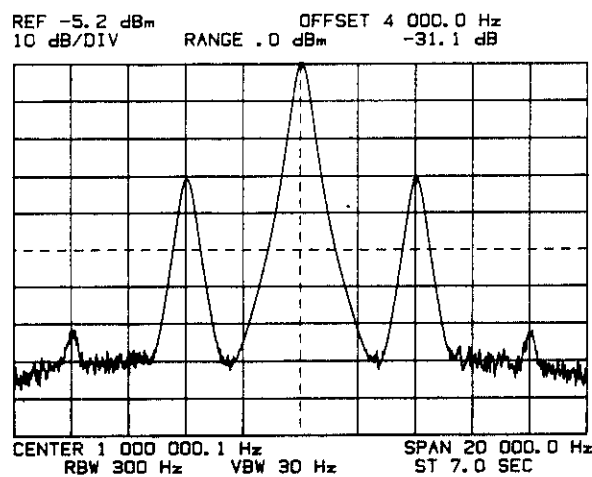
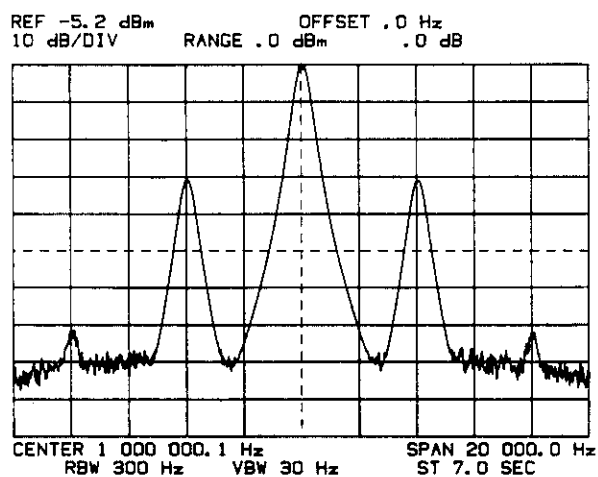
The 3585 OFFSET function can be used to measure the relative frequency and amplitude between any two points on the CRT trace.

EXAMPLE: Measure the frequency and amplitude of AM sidebands relative to the carrier:



- a. First, set the Marker to the peak of the carrier with  . Then activate  and press .
- b. Set the Marker to the peak of the upper (or lower) sideband with . (A stationary marker remains at the carrier frequency.) The "OFFSET" reading indicates the frequency and amplitude of the sideband relative to the carrier.*

NOTE

The "OFFSET" amplitude is always displayed in "dB". It cannot be displayed in volts.

*Modulation percentage can be calculated by: $200 \times \log^{-1} (\text{dB}/20)$. Where: "dB" = amplitude of one sideband relative to carrier.





STEP 6

Offset Counter Measurements

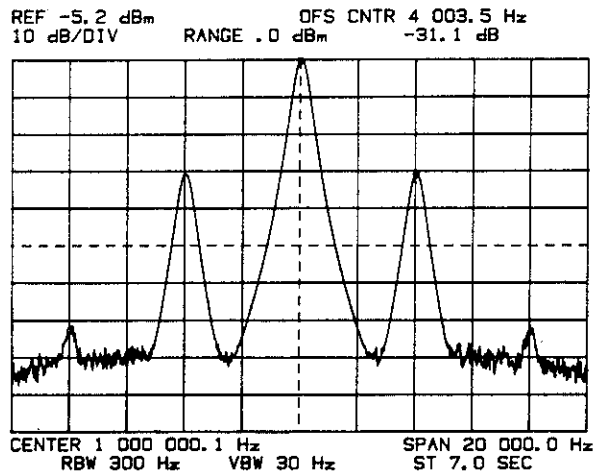
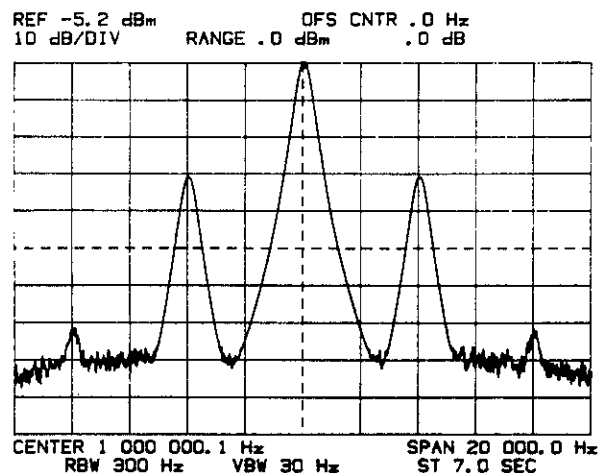
The COUNTER function can be used in conjunction with the OFFSET function to very accurately measure the frequency difference between two signals.

EXAMPLE: use the Counter to precisely measure the frequencies of the AM sidebands relative to the carrier. (This is a more accurate version of the AM measurement given in the preceding example.)



- a. With  and  activated, set the Marker to the peak of the carrier with . Allow time for the "COUNTER" reading to appear in the top-right corner of the screen. Then activate  and press .

(The "COUNTER" reading indicates the true absolute carrier frequency. Pressing  stores the "COUNTER" reading in the Offset Register.)





- b. Set the Marker to the peak of the upper (or lower) sideband with . Allow time for the "OFS CNTR" reading to appear. As indicated by the "OFS CNTR" reading, the true difference frequency is 4,003.5 Hz as opposed to the 4,000.0 Hz reading obtained in the preceding example.

(The "OFS CNTR" reading indicates the difference between the carrier frequency in the Offset Register and the counted frequency of the upper sideband.)

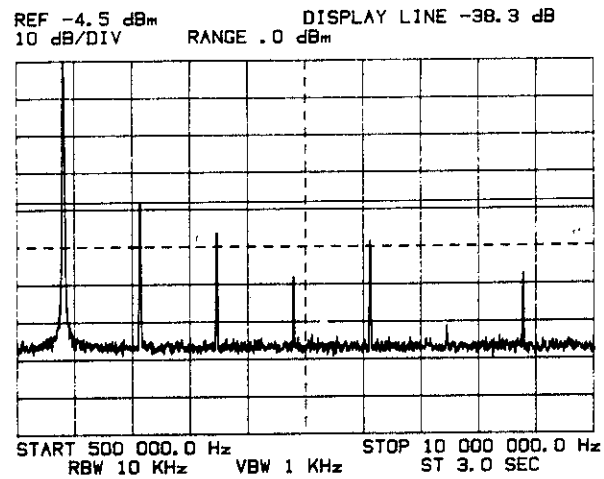
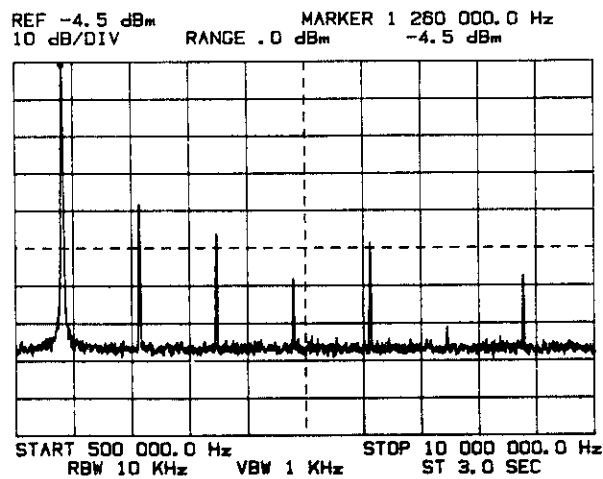





Measure Signals In "dB" Relative To Reference Level Using Display Line

EXAMPLE: Measure harmonics in "dB" relative to the fundamental:





- a. Set Marker to peak of fundamental with  . Move fundamental to top of screen by pressing .
- b. Activate . Set Display Line to peak of harmonic to be measured with . The "DISPLAY LINE" readout indicates the harmonic's amplitude in "dB" relative to the fundamental; i.e., the Reference Level.

NOTE

When  is activated, the Marker disappears from the screen and the "DISPLAY LINE" amplitude is displayed in place of the "MARKER" (or other) reading in the upper-right-hand corner of the screen. Pressing the Display Line  key clears the Display Line and its readout from the screen; but it does not return the Marker to the screen. To restore the Marker and its readout, activate  or  or  or press .

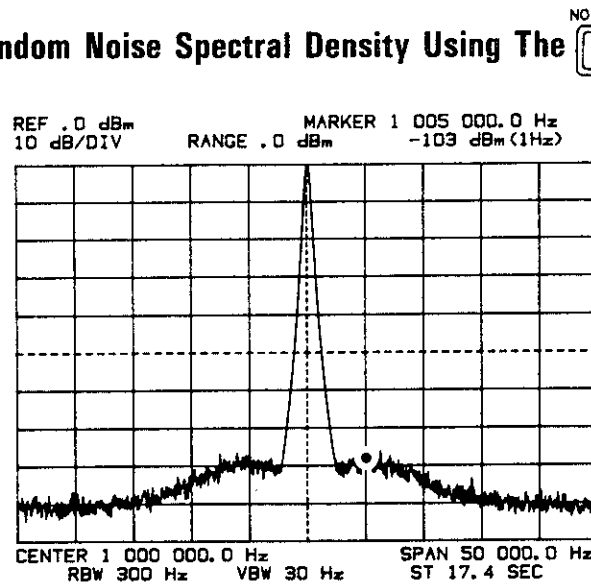
SPECIAL MEASUREMENT TECHNIQUES

Measure Random Noise Spectral Density Using The  Function

Set the Marker to the point of interest on the noise floor. Activate  and allow time for the noise level ("dBm (1 Hz)", "dBV (1 Hz)"; or " $\sqrt{\text{V}}\text{Hz}$ ") to appear in place of the Marker amplitude in the upper right-hand corner of the screen. The noise level reading indicates the rms random noise spectral density at the Marker, normalized to a 1 Hz noise power bandwidth.

NOTES

1. When the analyzer is sweeping, the sweep stops at the Marker frequency to permit the noise reading to be calculated. While the noise reading is being calculated, the suffix of the current amplitude or noise level reading is displayed brighter than normal. At the end of the noise calculation, the sweep resumes and the suffix returns to normal brightness to indicate that a valid noise level reading is available. The noise measurement time varies from approximately 0.3 seconds to 33 seconds, depending on the RBW setting. Narrow bandwidths require longer measurement periods.
2. The noise being measured must be random noise. The NOISE LVL function cannot be used to measure impulse noise or other signals containing discrete, phase-coherent frequency components.
3. To obtain accurate noise level readings, the RBW must be narrow enough to resolve a relatively flat portion of the noise spectrum.
4. The requirements for using the NOISE LVL and COUNTER functions are conflicting-If the Marker is on the noise, the Counter will not operate properly; if the Marker is on a signal, the noise reading will be inaccurate. Therefore, deactivate the COUNTER when using the NOISE LVL function (and vice-versa).
5. Changing the Marker frequency or any of the frequency or amplitude parameters will abort the noise calculation (if any) currently in progress.

Measure Signal-To-Noise Ratio Using The And Functions

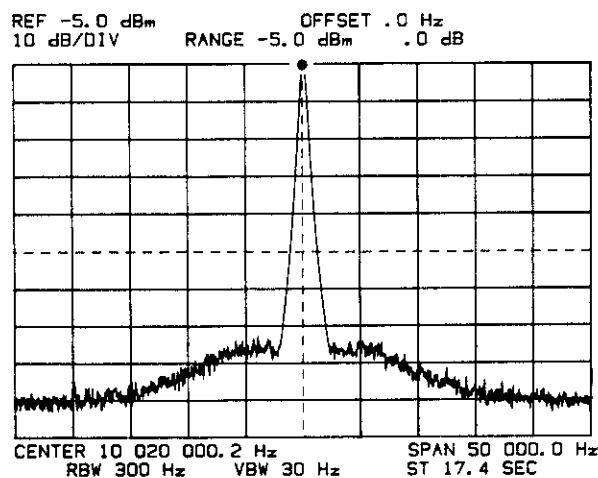

- a. Set the Marker to the peak of the signal with . Activate and press .

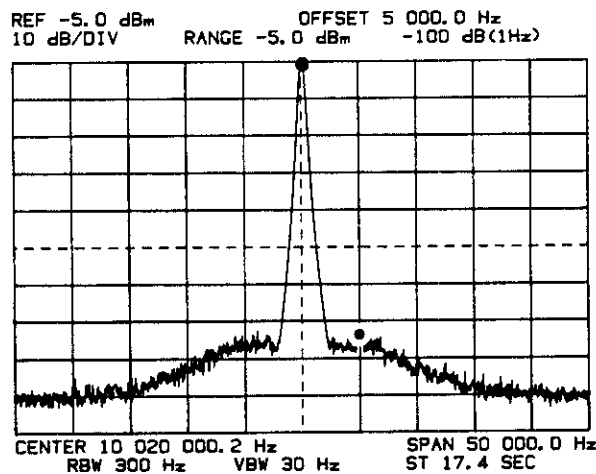









- b. Set the Marker to the point of interest on the noise floor with . Activate and wait for the "dB (1 Hz) reading to appear.

(The "dB (1 Hz) reading indicates the rms noise spectral density at the Marker in a 1 Hz bandwidth *relative* to the carrier amplitude.)

SPECIAL MEASUREMENT TECHNIQUES
Step CF Measuring Harmonic Distortion

Step The Center Frequency To Measure Equally Spaced Portions Of The Spectrum





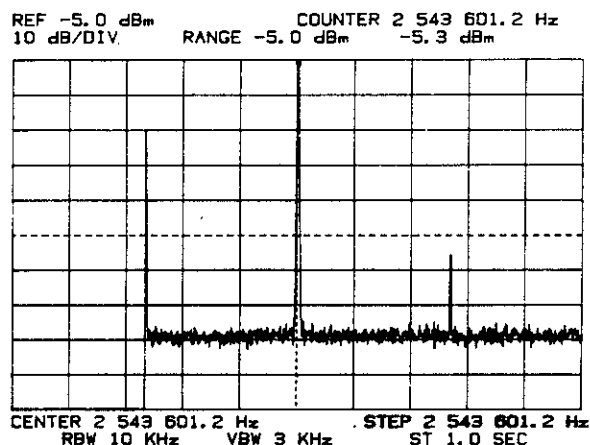
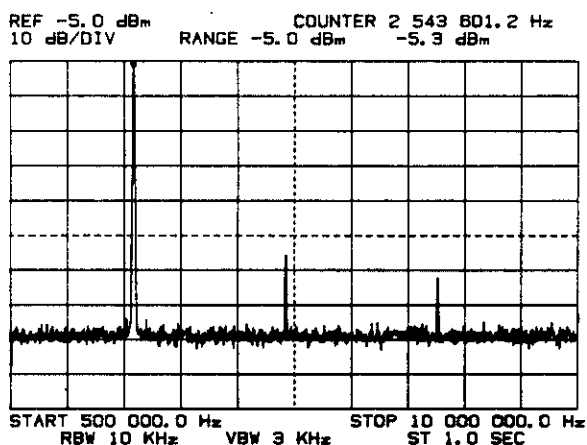

Pressing   OR  changes the Center Frequency in steps equal to the Center Frequency Step Size. The Center Frequency Step Size is settable within the range of 0 Hz to 40.1 MHz with 0.1 Hz resolution. It can be changed by Marker/Offset Entry, Step Entry or Numeric Entry:

- Marker/Offset:  Sets CF Step Size equal to the current Marker, Counter, Offset or Manual frequency (whichever is being displayed).
- Step Entry:    Changes CF Step Size to next value in a 1, 2, 5, 10 sequence.
- Numeric Entry:   Selects a specific step size; 0 Hz to 40.1 MHz, 0.1 Hz resolution.

The ability to step the Center Frequency makes it possible to survey a wide frequency range in sequential pieces with high resolution. This is particularly useful for close-in observation of equally-spaced signals such as distortion products, modulation side frequencies, communication channels, etc. Here are some examples:

Measuring Harmonic Distortion



- a. Set the Marker to the peak of the fundamental with  . Move the fundamental to the top of the screen by pressing . Activate  to precisely measure the fundamental frequency.
- b. Move the fundamental to the center of the screen by pressing  (or by numerically setting the Center Frequency equal to "COUNTER"). Set the Center Frequency Step Size equal to the fundamental frequency (i.e., "COUNTER" frequency) by pressing  or by Numeric Entry.

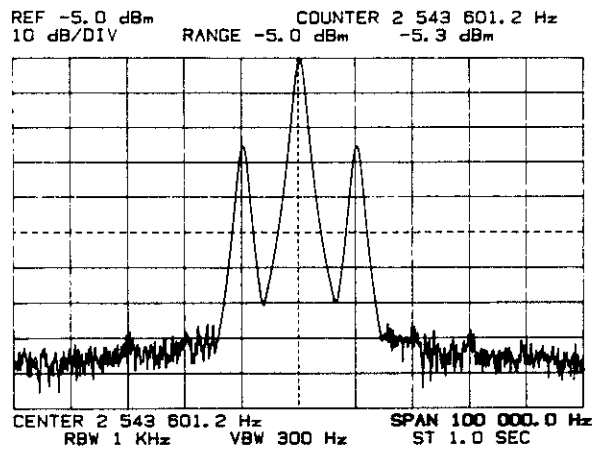

SPECIAL MEASUREMENT TECHNIQUES

Measuring Harmonic Distortion



- c. Narrow the Frequency Span about the Center Frequency to obtain the required resolution. If necessary, reposition the Marker to the peak of the response.

(Due to the changes in Bandwidth and Sweep Time, the response may have moved slightly off center.)

If you wish to measure the succeeding harmonics in "dB" relative to the fundamental, activate  and press .

NOTE

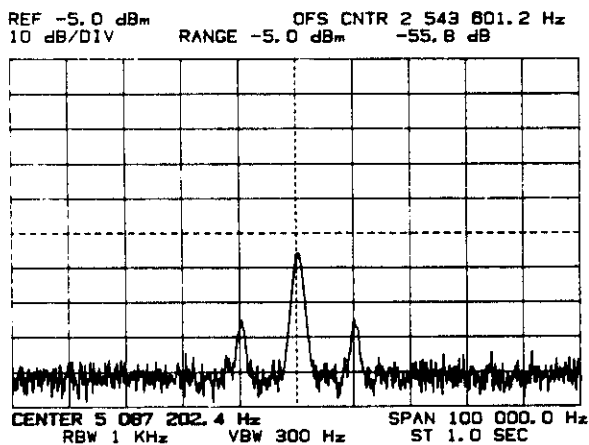

If the harmonics to be measured are not at least 20 dB above the noise, deactivate .

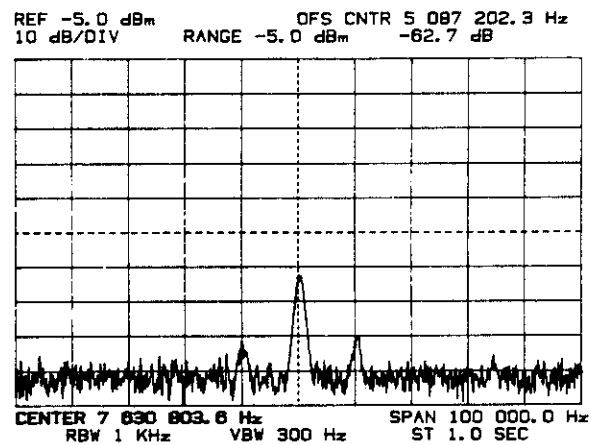

Second Harmonic

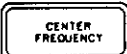

Third Harmonic

- d. Press   to display and measure succeeding harmonics.

(If desired, individual harmonics can be moved to the top of the screen by pressing . Also, the VBW can be narrowed to obtain better noise averaging.)

SPECIAL MEASUREMENT TECHNIQUES

Measuring Modulation Side Frequencies



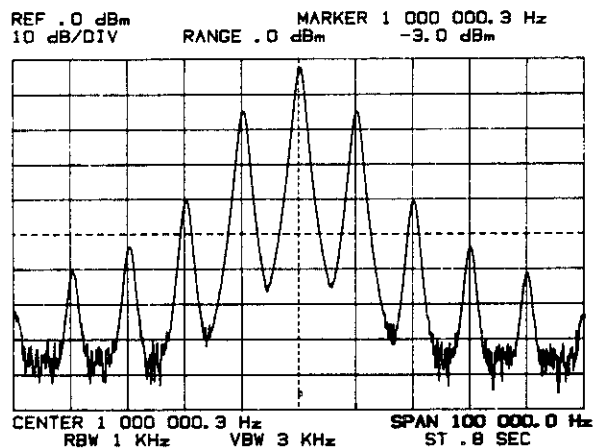

Measuring Modulation Side Frequencies

A 100 kHz span displays a 1 MHz carrier that is amplitude modulated by a signal whose frequency is approximately 10 kHz. The display shows the carrier and the upper and lower sidebands, containing the fundamental modulation side frequencies and their harmonics.

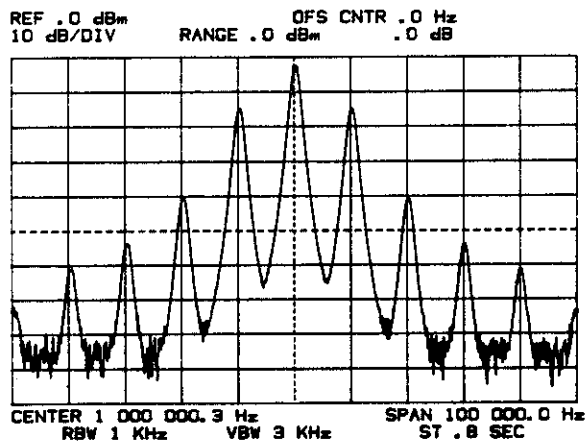

To individually measure the modulation side frequencies and harmonics with high resolution:



- a. Set the Marker to the peak of the carrier with  . Activate  to precisely measure the carrier frequency. Store the carrier frequency and amplitude in the Offset Register by activating  and pressing .

SPECIAL MEASUREMENT TECHNIQUES

Measuring Modulation Side Frequencies

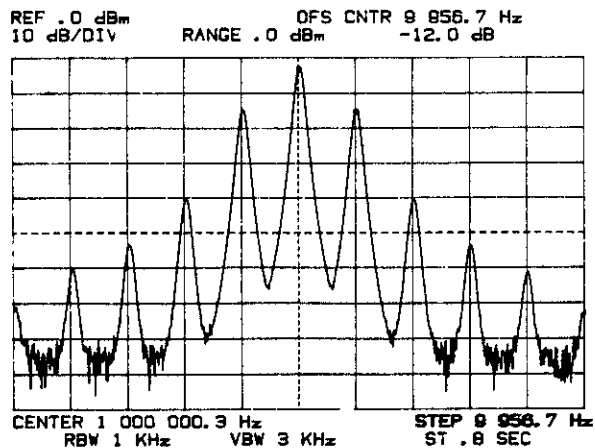

- b. Set the Marker to the peak of the upper (or lower) side frequency. The "OFS CNTR" (Offset Counter) reading indicates the difference between the carrier frequency in the Offset Register and the counted side frequency on which the Marker is positioned. The amplitude readout indicates that the side frequency is 12 dB below the carrier.

Set the Center Frequency Step Size exactly equal to the "OFS CNTR" frequency by pressing  or by Numeric Entry.

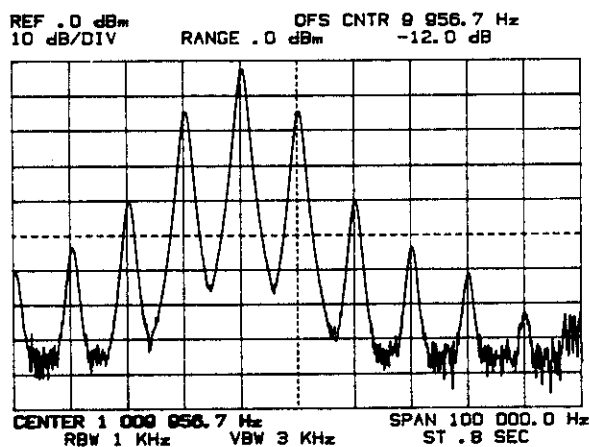

- c. Move the upper side frequency to the center of the screen by pressing



(This sets the Center frequency exactly equal to the *absolute* Counter frequency.)

Deactivate 

(The Counter is no longer needed and some of the higher order harmonics are too near the noise to be measured with the Counter.)

SPECIAL MEASUREMENT TECHNIQUES

Measuring Modulation Side Frequencies

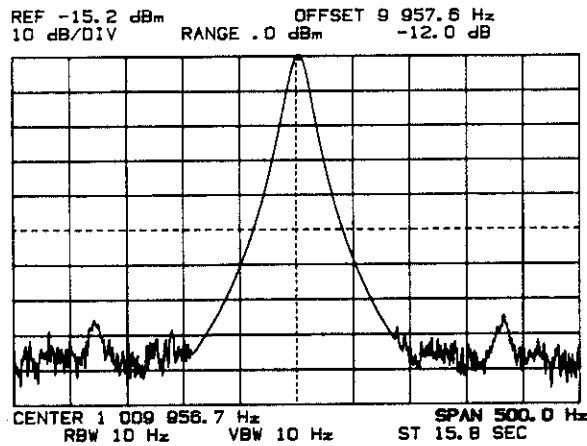

- d. Narrow the Frequency Span about the Center Frequency to obtain the required resolution. Due to the change in Bandwidth and Sweep Time, the response may be skewed slightly off center, making it necessary to reposition the Marker. With the marker set to the peak of the response, move the response to the top of the screen by pressing . If you wish to measure succeeding harmonics in "dB" relative to the fundamental (rather than the carrier) press .

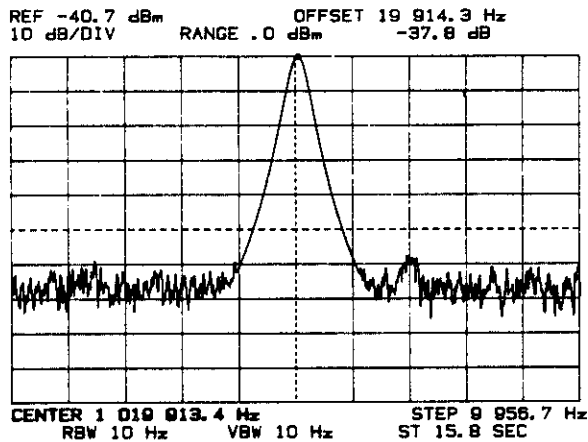

Second Harmonic

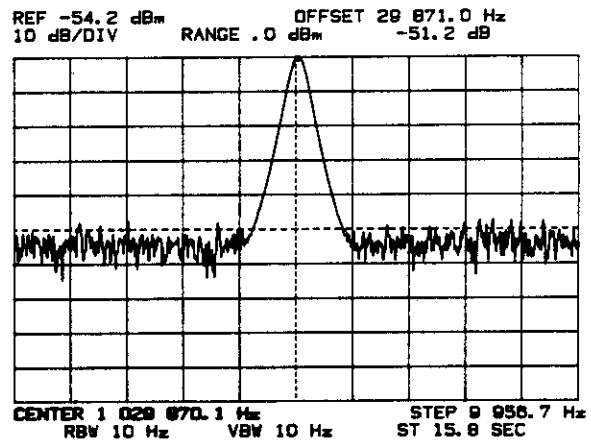

Third Harmonic

- e. Press to display and measure succeeding harmonics. If desired, press to move each response to the top of the screen for measurement.

IMPROVING THE NOISE-FREE AND DISTORTION-FREE DYNAMIC RANGE

NOTE

The following procedures for improving the noise-free and distortion-free dynamic range are intended primarily for use with the Terminated input. The distortion characteristics of the High-Impedance input vary according to the specific Range setting that is being used and, therefore, do not conform to the distortion characteristics referred to in these procedures. The procedure for overdriving to improve the noise-free dynamic range can be applied to the High-Impedance input at frequencies above 200 kHz. (At lower frequencies, the noise-vs.-Range characteristics of the High-Impedance input vary as a function of frequency and source resistance.)

Overdrive To Improve Noise-Free Dynamic Range

When measuring the low-level spurious components or noise of an external source, it is sometimes beneficial to decrement the Range one or two steps below the optimum (automatic) setting. This overdrives the input circuitry (OVERLOAD light on) and increases the internal distortion; but it also improves the internal signal-to-noise ratio, making it possible to measure low-level signals that would otherwise be affected by the analyzer's internal noise.

Overdriving will not damage the instrument as long as the input-signal level is below the maximum input level printed on the front panel. The 3585 is designed to permit the inputs to be overdriven up to 12.3 dB above the Range setting.

Decreasing the Range one step (5 dB) increases the internal signal level by 5 dB and provides a corresponding 5 dB increase in the signal-to-noise ratio.

In the 12.3 dB overdrive region (Terminated input), the internal distortion increases predictably as a function of the internal signal level. A 5 dB increase in the internal signal level will increase the internal second-harmonic and second-order IM distortion by about 5 dB; and will increase the third-harmonic and third-order IM distortion by about 10 dB. The overdrive mode can be used to *locate* low-level distortion products; but it *must not* be used to measure distortion since the analyzer's internal distortion may significantly contribute to the measurement.

IMPROVING DYNAMIC RANGE

Overdriving

Example Of Overdriving

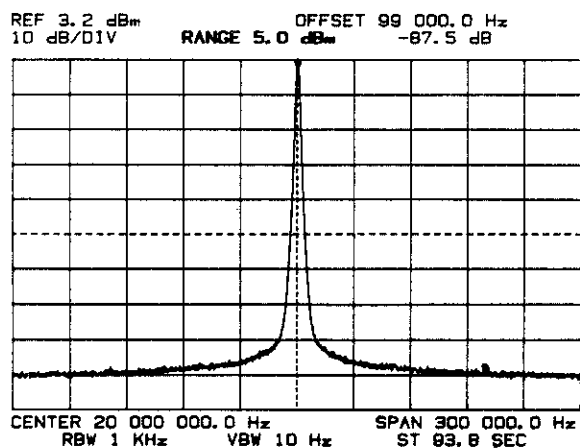

With RANGE set to +5 dBm, low-level spurious responses masked by the analyzer's internal noise *and* the noise of the external source are difficult to see and measure even with a narrow VBW.

NOTE

To keep the signal at the top of the screen, deactivate  before changing the Range setting. If downranging causes the noise to drop below the bottom of the screen, it will be necessary to lower the Reference Level to display the noise and the low-level responses. This will not affect the overdrive measurement.

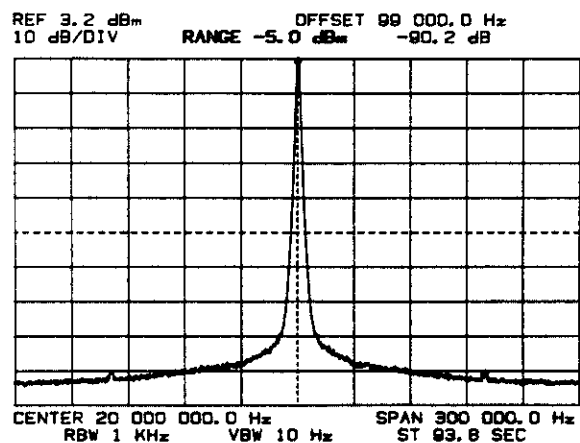

Decrementing the RANGE to -5 dBm (10 dB) reduces the internal noise level by 10 dB, providing a substantial improvement in the signal-to-noise ratio. The low-level spurious responses are still near the noise level of the external source; but the analyzer's internal noise is no longer contributing to the measurement.

Because of the decrease in noise, the relative amplitude of the response being measured is about 3 dB *lower* than it was previously. If downranging *increases* the amplitude of a response (with respect to the signal) that response is a *distortion* product.

Underdrive To Optimize Distortion-Free Dynamic Range

Downranging increases the internal signal level and improves the signal-to-noise ratio at the cost of higher distortion. Up-ranging, on the other hand, decreases the internal signal level and decreases the internal distortion but also decreases the signal-to-noise ratio.

By initially selecting a narrow Resolution Bandwidth and compatible Video Bandwidth to reduce the noise, the distortion-free dynamic range can be optimized by simply up-ranging until the distortion products being measured either remain at a constant amplitude (with respect to the fundamental or driving signal) or converge with the noise:

- a. If the relative amplitude of a distortion product does not change significantly when the Range is incremented, the measurement is free of internal distortion.
- b. If up-ranging causes the relative amplitude of a distortion product to decrease, internal distortion is contributing to the measurement. If a distortion product disappears in the noise and the Resolution Bandwidth is already set to 3 Hz, nothing more can be done to reduce the noise; but the measurement at least reveals that the distortion is below the noise level.

Example Low-Level Distortion Measurement *

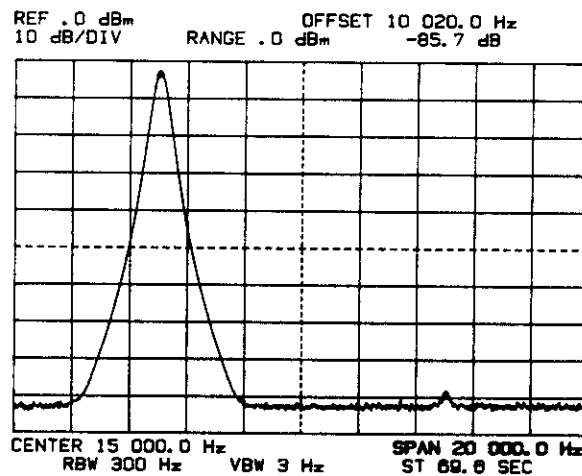



- a. A 20 kHz Span displays the fundamental and low-level second harmonic of a 10 kHz signal source whose specified second harmonic distortion is 90 dB below the fundamental. As indicated by the "OFFSET" reading, however, the harmonic appears to be only 85.7 dB down. The 3585 's internal second harmonic distortion is specified to be at least 80 dB below the signal; so, in this case, internal distortion could be contributing to the measurement. One way to find out is to "zoom-in" on the second harmonic, narrow the Span and Bandwidth and then increment the Range to optimize the distortion-free dynamic range.

*This same measurement could be made much more efficiently using the 3585 's "Manual mode" which is described in the following chapter. The techniques illustrated in this example can be used in the Manual mode and can also be applied when making IM distortion measurements. Internal distortion is generally not a concern unless you are measuring second or third harmonic distortion that is more than 80 dB below the fundamental; second-order IM products that are more than 70 dB below the larger of the two driving signals; or third-order IM products that are more than 80 dB below the larger of the two driving signals.

IMPROVING DYNAMIC RANGE

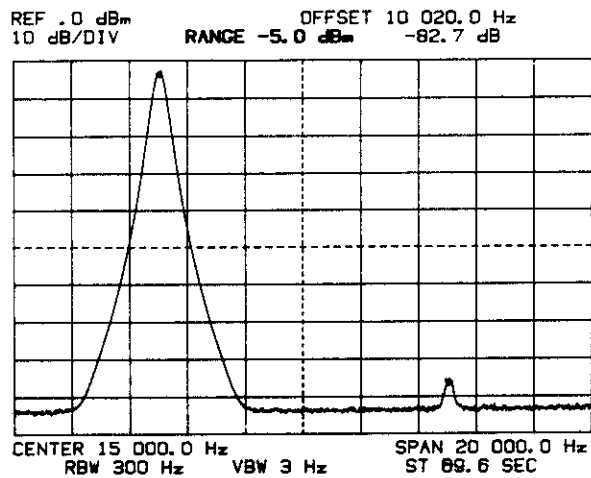
Underdriving



- b. Downranging one step (with  deactivated) decreases the internal noise level and increases the internal second-harmonic distortion making it easy to pinpoint the second-harmonic response.

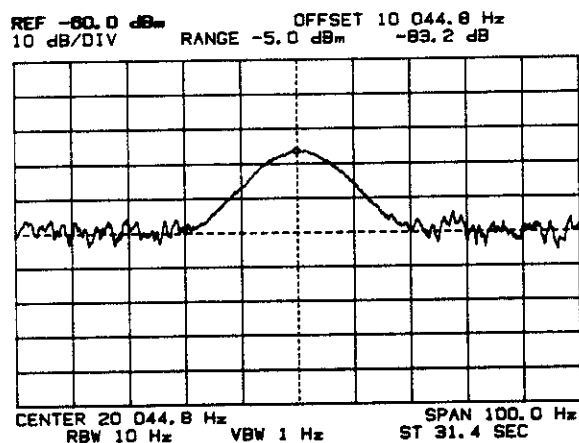

- c. Second-harmonic response moved to center of screen and displayed with 100 Hz Span and 10 Hz RBW. Reference Level lowered to -60 dBm to display signal and noise in upper portion of CRT screen.

(The 3 Hz RBW would provide a lower noise level; but the 10:1 RBW/VBW ratio, unobtainable with the 3 Hz RBW, provides better noise averaging.)

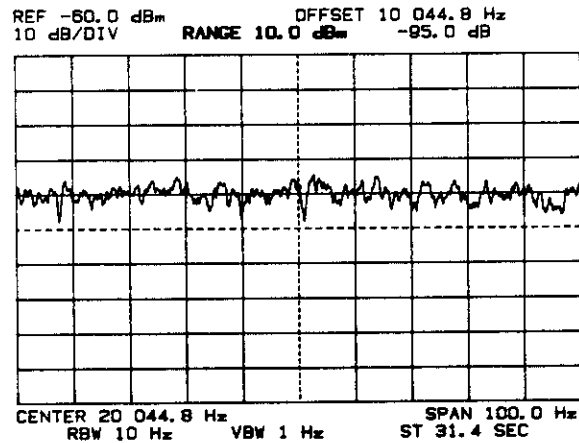
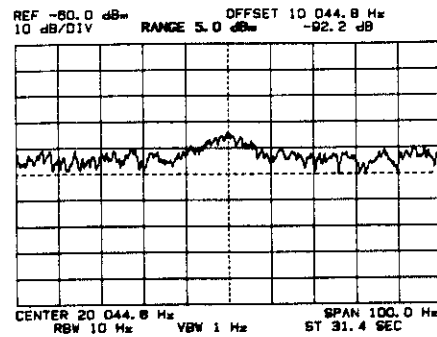
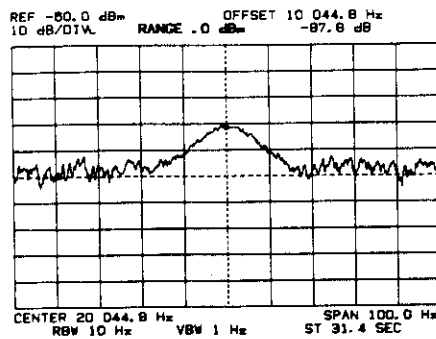

- d. Incrementing the Range decreases the harmonic's amplitude, indicating that internal distortion is contributing to the measurement.

As shown in the figures, the second harmonic finally converged with the noise when the Range was incremented to + 10 dBm. With the signal buried in noise, it was impossible to obtain an exact reading. However, the average noise level at that point was about 97 dB below the fundamental; so we were able to conclude that the harmonic was at least 97 dB down and certainly well-within its 90 dB specification.

TRACKING GENERATOR

AMPLITUDE FREQUENCY-RESPONSE MEASUREMENTS USING THE TRACKING GENERATOR

Tracking Generator

The 3585 TRACKING GENERATOR output supplies a 20 Hz to 40.1 MHz sinusoidal output signal whose frequency follows or "tracks" the swept or manually-tuned frequency of the instrument. The frequency accuracy of the Tracking Generator output signal is ± 1 Hz, relative to the instrument's tuned frequency. Amplitude flatness is ± 0.7 dB over the 20 Hz to 40.1 MHz frequency range. The Tracking Generator output is dc coupled; its output impedance is 50 ohms; and the return loss is > 20 dB. When terminated in a 50-ohm load, the Tracking Generator output level can be adjusted from approximately -11 dBm/50 Ω to 0 dBm/50 Ω using the front panel AMPLITUDE control. (The output level cannot be programmed remotely.)

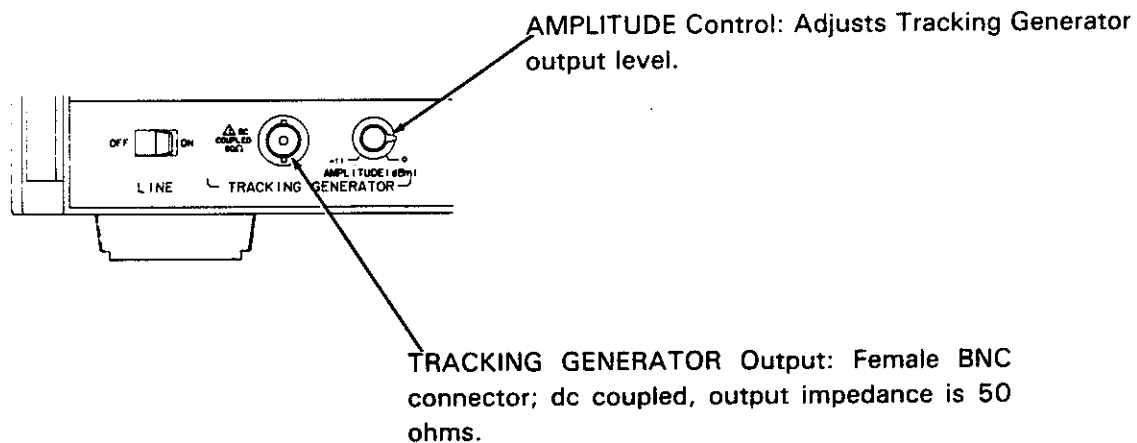

The TRACKING GENERATOR output is dc coupled. Peak (combined ac/dc levels exceeding ± 0.1 volts applied to this output will affect the bias of the output amplifier and prevent it from operating properly. Peak input levels exceeding ± 3 volts may damage the output circuitry.

TRACKING GENERATOR Closed-Loop Measurements

Frequency Offset

The tracking generator frequency can be offset up to 5 kHz above or below the analyzer's tuned frequency using the Tracking Generator Offset mode. (More information exists under "Test Modes" in Chapter 9.) This mode is used as described in the following procedure:

1. Press (blue) Offset; toggles the tracking generator feature on and off.
2. Set the CF Step Size to the desired frequency offset (0 to 5 kHz with 0.1 Hz resolution).
3. Force a calibration by pressing (blue) Cal On (under the 4 key in the numeric keypad).
4. After completing your measurement, deactivate the Tracking Generator Offset Mode by presetting the instrument or pressing (blue) Offset again.

Closed-Loop Measurement Configuration

The 3585 Tracking Generator output can be used to make "closed-loop" amplitude frequency-response measurements as typified by this setup:

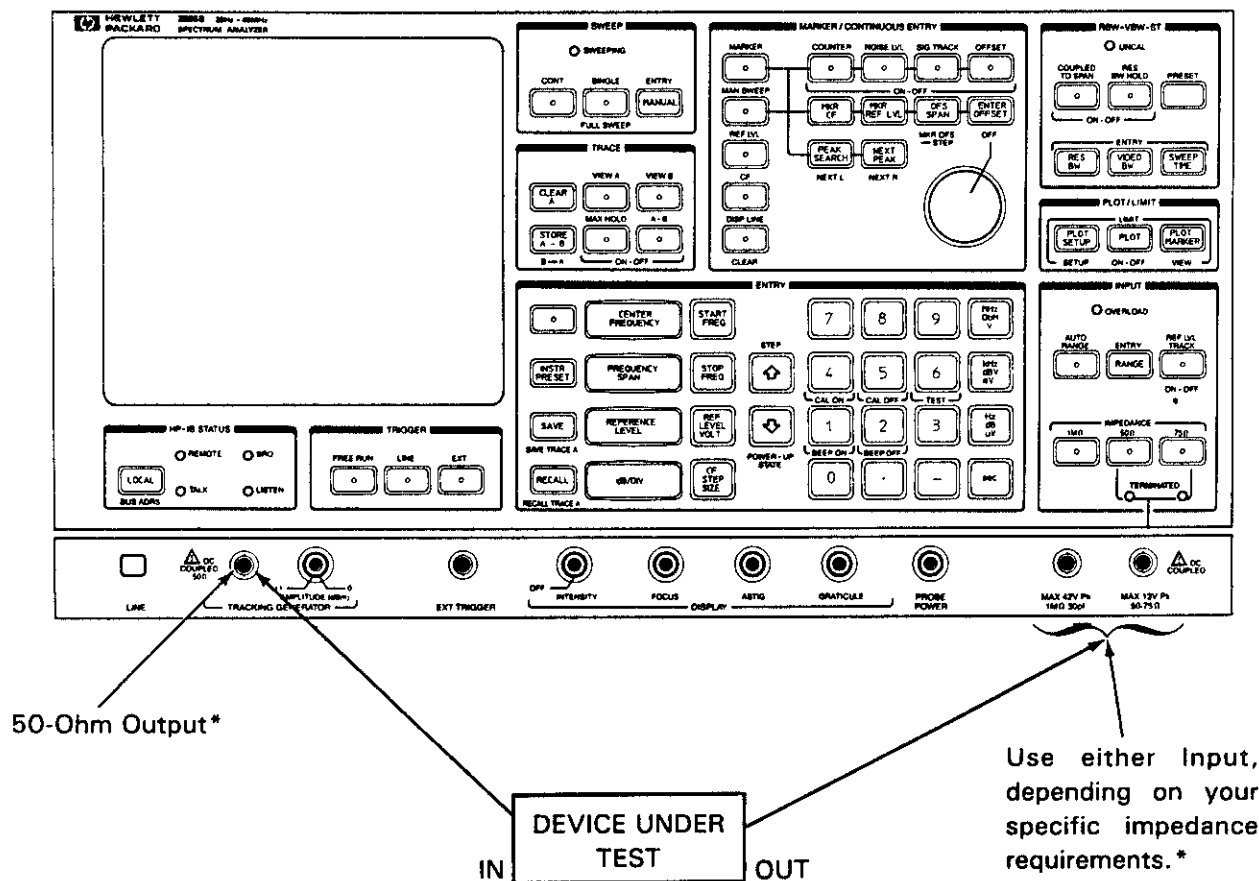

*External impedance matching networks and/or terminations may be required.

TRACKING GENERATOR

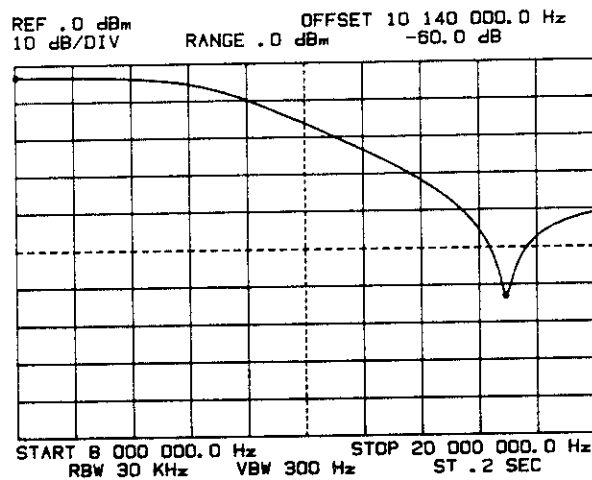

Closed-Loop Measurements

In the closed-loop configuration, the 3585 functions as a network analyzer for measuring the amplitude-vs.-frequency characteristics of two-port networks such as filters, amplifiers, mixers, attenuators, etc. The network or device to be characterized is inserted between the Tracking Generator output and the Terminated or High-Impedance input. The Tracking Generator output then serves as an excitation source or "stimulus" for the network under test and the 3585 measures the response. As the analyzer's frequency is swept or manually tuned over the band of interest, the amplitude variations introduced by the network are measured and retained on the CRT, yielding an amplitude-vs.-frequency plot of the network.



A frequency sweep from 8 MHz to 20 MHz displays the stopband response of a 9 MHz low-pass filter.

NOTE

When making swept frequency response measurements, always deactivate the  function. (With  activated, the instrument automatically upranges and downranges in response to the amplitude variations introduced by the Tracking Generator and network under test.)

General Measurement Procedures

The following are general procedures for making two basic types of amplitude frequency-response measurements:

1. General Device Characterization:

For general-purpose measurements where the device or network (e.g., a filter) exhibits relatively large amplitude variations and the frequency response deviations of the 3585 and Tracking Generator are insignificant.

2. Insertion Loss and Flatness Measurements:



To precisely measure the insertion loss (or gain) and flatness characteristics of a device by subtracting the analyzer's frequency response deviations from the measurement using the "A-B" TRACE function.

General Device Characterization

a. Press . Select the desired input impedance and activate the Input that is to be used for measurements. Enter the desired Start and Stop frequencies.



b. If you wish to adjust the Tracking Generator output level before connecting the device or network to be tested, proceed as follows; if not, go to Step c.



1. Increment the Range to 0 dBm with  . Leave the  function deactivated.

2. To set the Tracking Generator level in dBV or volts, press   OR .

3. Connect the Tracking Generator output (externally terminated if necessary) to the Input that is to be used for measurements.

4. Using the Tracking Generator AMPLITUDE control, set the Tracking Generator output to the desired level. (The level can be read directly from the "MARKER" amplitude readout in the upper right-hand corner of the CRT screen.)

c. With  , set the Marker to a frequency that will produce the maximum output level of the device or network under test.

1. Press  .



2. Insert the device or network to be tested between the Tracking Generator output and the Input that is to be used for measurements. (Use external impedance matching networks and/or terminations if required.)

3. With  activated, allow the instrument to automatically select the appropriate Range setting. (At this point, you may also adjust the Tracking Generator AMPLITUDE control to obtain the required signal level as indicated by the "MANUAL" amplitude readout.)



4. Deactivate the  function.

TRACKING GENERATOR

General Device Characterization

- d. Activate the  or  SWEEP function. After a complete frequency sweep has been made, the network's response curve will be displayed on the CRT. You may then use the tunable Marker to measure the response in absolute units of dBm, dBV or rms volts; or use the OFFSET function to measure the relative frequency and amplitude between any two points on the curve.

OPERATING HINTS



1. To improve the noise-free dynamic range, deactivate  and downrange two steps (if possible) from the Range that was selected automatically. If you are only interested in observing the stopband of a filter's response, you may reactivate  and continue to downrange all the way to -25 dBm. (The OVERLOAD indicator will light to indicate that the input is being overdriven and that the instrument will no longer meet its distortion specifications. During network-analysis measurements, however, the analyzer does not "see" internal or external distortion products. As long as the input is not overdriven to the point where excessive amplitude compression occurs in the region you wish to observe, the effects of overdriving are totally beneficial. Excessive amplitude compression begins to occur when the input level is greater than 12.3 dB above the Range setting.)

2. To further improve the noise-free dynamic range, narrow the Resolution Bandwidth and, for good noise averaging, set the Video Bandwidth to 1% of the RBW.

3. For network-analysis measurements, the Sweep Time can be substantially reduced from the automatic setting without degrading performance. The "optimum" Sweep Time must be determined empirically:

a. Sweep one time across the spectrum using a relatively slow sweep rate.

b. Store the trace in "B" by pressing .

c. While visually comparing the "A" Trace to the stored "B" Trace, decrease the Sweep Time with   until the "A" Trace begins to show signs of amplitude compression and/or frequency skew (ignore the UNCAL light). Then, increase the Sweep Time one step with



4. When the RBW is 3 kHz or less and the Sweep Time is 3.8 seconds or longer, the frequency sweep is interrupted at 1 MHz intervals to permit the instrument's local oscillator to be reprogrammed. These interruptions cause phase discontinuities in the tracking generator output. (More information exists under "Single Loop Mode" in Chapter 9.) This effect can be avoided by selecting Single-Loop Mode during the measurement setup:

- Press (blue) Res BW; toggles single-loop mode on and off.
- To deactivate the Single-Loop Mode after the measurement is complete, press (blue) Res BW again.

5. When the 3585 automatically calibrates, the Terminated input is internally switched to a 50-ohm or 75-ohm dummy load. During this switching operation, the input is open for an instant during which the stored energy in a resonant circuit may produce a voltage transient that is large enough to "trip" the internal protection circuit. When the protection circuit is activated, the input opens and the yellow TERMINATED light goes out. To reset the protection circuit, disconnect the signal source and then press any of the IMPEDANCE keys.













TRACKING GENERATOR

Insertion Loss/Flatness Measurements

Insertion Loss And Flatness Measurements

Procedure 1: Insertion loss (or gain) and flatness of unity-gain networks.

The following procedure can be used to very accurately measure the insertion loss/gain and flatness of unity-gain (± 5 dB) networks such as 1:1 passive or active probes, buffer stages and unity voltage gain power amplifiers.



- a. Press  .
 1. Select the desired input impedance and activate the Input that is to be used for measurements.
 2. Increment the Range to 0 dBm with   . Leave  deactivated.
 3. Enter the desired Start and Stop frequencies.
- b. Connect the Tracking Generator output (externally terminated if necessary) to the Input that is to be used for measurements.
 1. With   , reduce the Vertical Scale to 1 dB/DIV.
 2. Set the Marker to the frequency that you wish to use as the reference frequency for your measurement. (This is typically the Start Frequency.)
 3. Using the Tracking Generator AMPLITUDE control, set the Tracking generator output to the desired level as indicated by the "MARKER" amplitude readout. (The level can be set in dBm, dBV or volts, whichever is the most convenient.)
 4. Store the trace in "B" by pressing  .
 5. If you do not want to display the "B" Trace, deactivate the  function.
- c. Insert the network to be tested between the Tracking Generator output and the Input that is to be used for measurements. (Use external impedance matching networks and/or terminations if required.)
 1. Activate the  function. (Leave  activated.)
 2. With the "A-B" function activated, the frequency response deviations of the 3585's Tracking Generator and input channel (stored in "B") are subtracted from the network's response that is currently being written into "A". The "A-B" Trace, referenced to the middle horizontal line on the CRT graticule, indicates the insertion loss (or gain) of the network as a function of frequency. The amplitude of the "A-B" Trace, displayed *only* in "dB", can be read directly from the "MARKER" readout. To measure the *flatness* of the response curve, set the Marker to the reference frequency; activate  , press  and then tune the Marker to the specific frequencies of interest.

TRACKING GENERATOR



Insertion Loss/Flatness Measurements

- d. Insert the amplifier or attenuator to be tested between the Tracking Generator output and the Input that is to be used for measurements. (Use external impedance matching networks and/or terminations if required.)

1. For Amplifiers:

If you wish to adjust for a specific output level, set the Marker to the frequency of interest with   ; and adjust the Tracking Generator AMPLITUDE control and/ or amplifier gain to obtain the required level as indicated by the "MARKER" amplitude readout. Adjust the Reference Level as required to maintain an on-screen display. (The input may be overdriven up to 12.3 dB above the Range setting; so if the OVERLOAD indicator lights, you may ignore it.)

2. For Attenuators:



To adjust for a specific output level, set the Marker to the frequency of interest with   ; and adjust the Tracking Generator AMPLITUDE control and/or external attenuation to obtain the required level as indicated by the "MARKER" amplitude readout. Adjust the Reference Level as required to maintain an on-screen display.





OR

If the attenuator under test can withstand an 11 dB increase in the drive level and the output level is irrelevant, rotate the AMPLITUDE control fully clockwise. Adjust the Reference Level to maintain an on-screen display.

(Increasing the drive level will improve the signal-to-noise ratio; the OVERLOAD light may be ignored. If the attenuator's response curve is noisy, narrow the VBW to obtain good noise averaging and, if necessary, narrow the RBW to improve the noise-free dynamic range. As indicated in the preceding "OPERATING HINTS", the Sweep Time can be decreased from the automatic setting without degrading performance.)

- f. Adjust the Reference Level so that the response curve is about mid-screen or otherwise aligned as closely as possible with the "B" Trace. (This is done so that the "A-B" trace will initially appear about mid-screen.)

- g. Activate the  TRACE function (leave  activated).



1. If necessary, adjust the Reference Level so that the entire response curve is on the screen.
2. To measure the flatness of the response curve, set the Marker to the reference frequency with   ; activate  , press  and then tune the Marker to the specific frequencies of interest with  .

Procedure 2: Precise flatness measurements for amplifiers and attenuators.



a. Press  .

1. Select the desired input impedance and activate the Input that is to be used for measurements.
2. Enter the desired Start and Stop frequencies.
3. Set the Tracking Generator AMPLITUDE control fully counterclockwise. (If a specific drive level is required, set the Range to 0 dBm; connect the Tracking generator output to the 3585 Input and then adjust the AMPLITUDE control for the desired level as indicated by the "MARKER" amplitude readout.)

b. 1. For Amplifiers:



With   , manually select the Range that is to be used for measurements. (Select a Range that is high enough to accommodate the maximum output level of the amplifier.)

2. For Attenuators:

With   , set the range to -20 dBm.

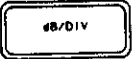

c. Connect the Tracking Generator output (externally terminated if necessary) to the Input that is to be used for measurements.



1. Adjust the Reference Level so that the response curve is within the top one or two divisions of the CRT graticule.*

2. With   , reduce the Vertical Scale according to the maximum expected peak-to-peak flatness variations of the amplifier or attenuator to be tested:

Maximum Flatness Variation	Vertical Scale
10 dB	1 dB/DIV
20 dB	2 dB/DIV
50 dB	5 dB/DIV

3. Adjust the Reference Level so that the response curve is on the screen, preferably about mid-screen.

4. Store the trace in "B" by pressing  . If you do not want to display the "B" Trace, deactivate  .

*A convenient way to adjust the Reference Level for this application is with   . If the Tracking Generator output is not terminated in 50 ohms, the signal level may be higher than 10 dB above the RANGE setting, in which case there will not be enough Reference Level adjustment range to move the response curve onto the screen. To correct this situation, increment the RANGE one or two steps.

CHAPTER 3

OPERATION IN THE MANUAL MODE

The purpose of this chapter is to familiarize you with the 3585's "Manual mode" and the various manipulative sequences that can be used to set the Manual frequency and perform real-time amplitude and frequency measurements.

Introduction To The Manual Mode

Most spectrum analyzers have a "manual sweep" mode which allows the operator to deactivate the frequency sweep and manually tune the analyzer's frequency with a knob or frequency dial. Notwithstanding, the 3585 also has a "Manual mode" which provides this same basic capability. Unlike traditional instruments, however, the 3585 has synthesizer tuning, automatic calibration, and Marker/Counter functions which greatly enhance the useability of the Manual mode. In fact, the Manual mode adds a complete new dimension to the 3585's operating capabilities. Once you become familiar with it, you will find that it is one of the most efficient ways to use the instrument; whether you are operating from the front panel or remotely programming via the HP-IB.

In the Manual mode, the 3585 functions as a tunable receiver or "selective voltmeter" which can be set to any frequency within the Frequency Span. The frequency to which the analyzer is tuned in the Manual mode is referred to as the "Manual frequency". The Manual frequency can be manually tuned or "swept" using the Continuous Entry control; but more importantly, it can also be entered numerically with 0.1 Hz resolution; it can be incremented or decremented in user-defined steps using the STEP keys; or it can be set using the instrument's tunable Marker. The ability to precisely set the Manual frequency allows you to make real-time, high-resolution measurements at the specific frequencies of interest without waiting for a frequency sweep.

Responses retained on screen after Manual mode measurement appear as vertical lines:

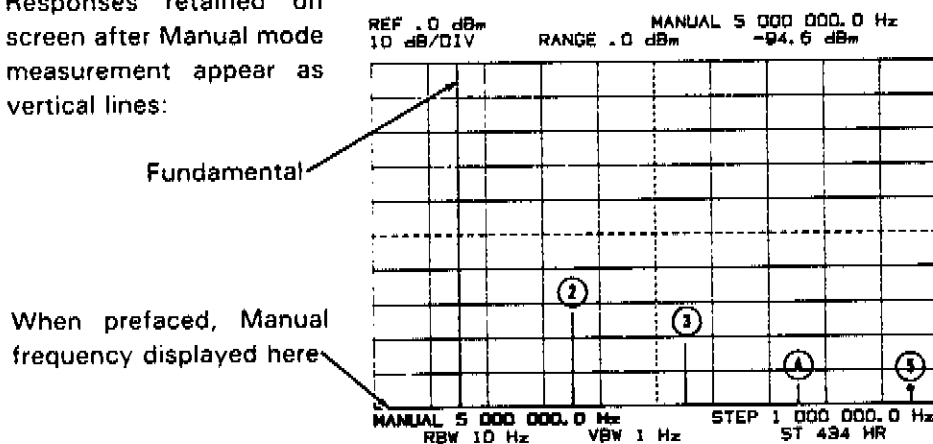

Low-Level harmonics of 1 MHz signal quickly measured with narrow bandwidth by stepping Manual frequency. Fifth harmonic is 94.6 dB below fundamental.

INTRODUCTION TO MANUAL MODE





One point on the CRT trace is used to represent the Manual frequency. That point is referred to as the "Manual measurement point". The Manual measurement point is continuously updated to reflect the real-time signal amplitude within the analyzer's passband at the Manual frequency. When the Marker is at the Manual measurement point, the Manual frequency and real-time signal amplitude can be read directly from the "MANUAL" readout which appears (in place of the "MARKER" readout) in the upper right-hand corner of the CRT screen.

Narrowing the Resolution Bandwidth increases the selectivity, making it possible to separate signals that are closely spaced in frequency. This also reduces the internal noise level which, in turn, improves the analyzer's sensitivity or ability to discern low-level signals. Narrow bandwidths require slow sweep rates and are impractical to use when sweeping over a wide frequency range. In the Manual mode, however, the analyzer can be quickly tuned to the exact frequencies of the signals that you wish to measure. Narrow bandwidths can be used to resolve and precisely measure any signals within the analyzer's dynamic range and Frequency Span.

Another important advantage of the Manual mode is that it provides a substantial improvement in amplitude measurement accuracy. In the Manual mode, the 3585 automatically calibrates at the Manual frequency rather than the Center Frequency of the Span.* This virtually eliminates frequency response errors that are normally encountered when the instrument is sweeping. The Manual mode also eliminates amplitude compression (and frequency skew) caused by sweep dynamics.

*When the Manual frequency is lower than 150 kHz, the Automatic Calibration is performed at 150 kHz.

Manual Key Functions

The Manual mode can be selected by pressing the  key, located in the SWEEP control block; or by activating the  function, located in the MARKER/CONTINUOUS ENTRY control block. Pressing either key initially sets the Manual frequency equal to the current Marker frequency. The instrument will remain in the Manual mode until the  or  SWEEP function is activated or  is pressed.

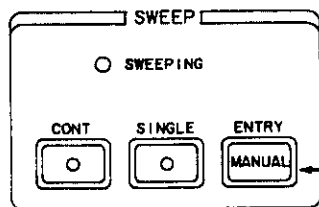



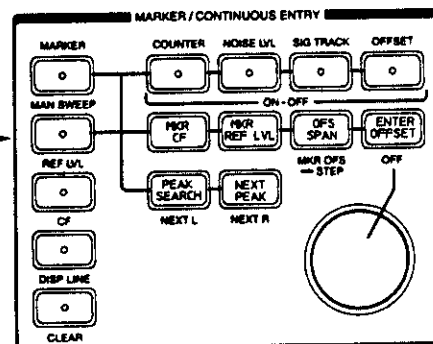

MANUAL Entry key:

- a. Selects Manual mode and *automatically activates* 
- b. Prefaces Manual frequency, enabling it to be changed by Step Entry or Numeric Entry.
- c. Sets the Manual frequency equal to the current Marker frequency.*

MANUAL SWEEP key:



- a. Selects Manual mode and sets Manual frequency equal to current Marker frequency.*
- b. Couples the Continuous Entry Control to the Manual frequency to permit manual frequency tuning. Once the instrument is in the Manual mode, this function can be deactivated by pressing the Continuous Entry  key or by activating  or any of the other Continuous Entry functions. Any of the MARKER/CONTINUOUS ENTRY functions can be used in the Manual mode.

*If the instrument is already in the Manual mode and the Marker is at the Manual measurement point on the CRT trace, pressing  or activating  will not change the Manual frequency.

MANUAL MEASUREMENT POINT

The Manual Measurement Point

The CRT trace is a point-by-point plot consisting of 1,001 equally spaced points. In the Manual mode, one of the points on the trace must be used to represent the Manual frequency. That point is referred to as the "Manual measurement point".

With 1,001 equally-spaced points, the frequency spacing between points is equal to the Frequency Span divided by 1,000. For example, if the Frequency Span is 40 MHz, the frequency spacing between points is $40 \text{ MHz}/1,000 = 40 \text{ kHz}$. Therefore, if the Frequency Span is 40 MHz and the Start Frequency is 0 Hz, there will be points at 0 Hz, 40 kHz, 80 kHz, 120 kHz, etc.

Since the Manual frequency is settable anywhere in the Span with 0.1 Hz resolution, the Manual frequency may either correspond to the frequency of a specific point or be between two points. For instance, the Manual frequency could be set to exactly 40 kHz, corresponding to the 40 kHz point; or it could be set to 49,123.4 Hz which is between the 40 kHz and 80 kHz points. When the Manual frequency corresponds to the frequency of a specific point, that point automatically becomes the Manual measurement point. When the Manual frequency is between two points, the Manual measurement point is typically the first point to the left of the Manual frequency.

The Manual measurement point on the Current ("A" or "A-B") Trace displays the real-time input-signal amplitude at the Manual frequency. The Manual measurement point is the only point on the trace that will reflect a change in the signal amplitude. It is updated at the CRT refresh rate of approximately 60 times per second.

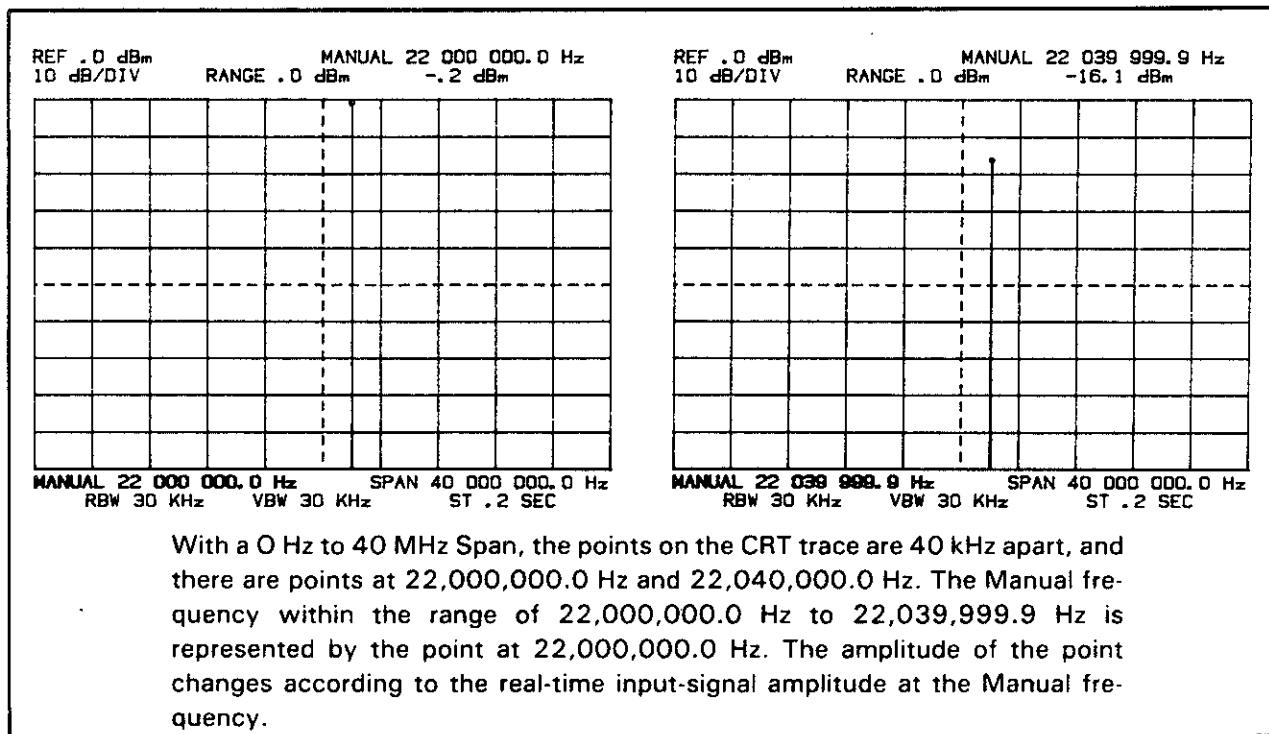





The Manual Measurement Point

Setting The Manual Frequency

The Manual Frequency can be set using any of five entry methods:

a. Marker Entry:



Set the Marker to the desired Manual frequency with  . Then, press  or activate . Marker frequency resolution is 0.1% of the Frequency Span.

b. Marker To Center Frequency:

Pressing  sets the Center Frequency equal to the Marker, Counter or Manual frequency (whichever is being displayed). If the Center Frequency is set equal to the Manual frequency, the Manual frequency does not change; but the Manual measurement point appears in the center of the screen. If the Center Frequency is set equal to the Marker or Counter frequency, the Manual frequency is automatically set equal to the Center Frequency.



c. Step Entry:    *

Changes Manual Frequency in steps equal to the Center Frequency Step Size. CF Step size is settable within the range of 0 Hz to 40.1 MHz with 0.1 Hz resolution.

d. Continuous Entry:  

Continuous adjustment of Manual frequency; used primarily for fine tuning to the peak of a response. As the frequency is manually tuned, the Marker dot jumps from point-to-point along the horizontal axis and deflects vertically to indicate the signal amplitude at the Manual frequency. The resulting trace is plotted and retained on the CRT screen.

Continuous Entry resolution is approximately 3% of the RBW or 0.1% of the Frequency Span (whichever is smaller). Maximum resolution is 0.1 Hz.

e. Numeric Entry:  

Manual frequency is settable to any frequency within the Frequency Span with 0.1 Hz resolution. Maximum Span is 0 Hz to 40.1 MHz.

*The Manual frequency can also be stepped by stepping the Center Frequency. This technique is described later in the chapter.



SETTING THE MANUAL FREQUENCY

Marker

NOTES

- 1. Changing any of the frequency parameters (i.e., Start, Stop, Center or Span) will automatically change the Manual frequency. The Manual measurement point does not move when the frequency parameters are changed. Therefore, a change in the frequency parameters redefines the frequency of the Manual measurement point and produces a corresponding change in the Manual frequency. (When the Manual frequency is equal to the Center Frequency, a change in Frequency Span will not affect the Manual frequency.)*
- 2. Changing the Manual frequency by Marker, Step or Numeric entry initiates an Automatic Calibration cycle. The calibration is performed immediately after the change is made at the new Manual frequency. (These calibrations are inhibited when the Manual frequency is lower than 150 kHz. Manual tuning by Continuous Entry does not initiate a calibration cycle.)*
- 3. When the Manual frequency is changed by Marker, Step or Numeric entry, the Marker immediately moves to the new Manual measurement point. However, an amplitude reading is not taken until the end of the Automatic Calibration cycle and the instrument's internal settling period. Settling times range from about 25 milliseconds to 2.5 seconds, depending on the RBW and VBW settings. (Narrow bandwidths require longer settling times.)*
- 4. When the Manual frequency is prefaced, the highlighted "MANUAL" frequency is displayed in place of "CENTER" or "START" in the lower left-hand corner of the CRT screen. This allows the operator to display the Manual frequency along with the Marker, Counter, Offset or Display Line information which may be displayed in place of the Manual frequency in the upper right-hand corner of the screen.*

The Marker

Pressing  and/or activating  automatically sets the Manual frequency equal to the current Marker frequency (i.e., the frequency of the point on which the Marker is positioned; *not* the Counter frequency). When the Manual frequency is changed, the Marker either moves to the new Manual measurement point or, if the Manual measurement point does not change, remains at the same point on the CRT trace. In either case, the Marker is always at the Manual measurement point immediately following a change in the Manual frequency.

When the Marker is at the Manual measurement point and the COUNTER, OFFSET and NOISE LVL functions are deactivated, the "MANUAL" readout in the upper right-hand corner of the screen indicates the Manual frequency and the real-time signal amplitude within the passband established by the Resolution Bandwidth setting.

NOTE

The CRT trace at the Manual measurement point is updated at the CRT refresh rate of approximately 60 times per second. However, the "MANUAL" amplitude readout is updated at a much slower rate of about five readings per second. This slower rate permits the operator to visually capture the amplitude variations of an unstable signal.

SETTING THE MANUAL FREQUENCY Marker

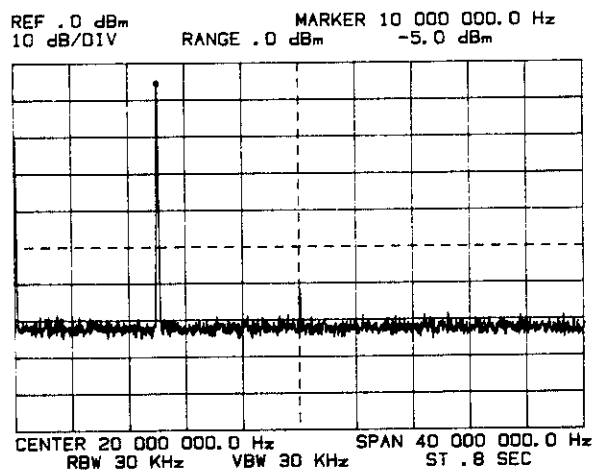

Marker at peak of 10.02 MHz response. During frequency sweep, peak displayed at 10.00 MHz point as indicated by "MARKER" readout.

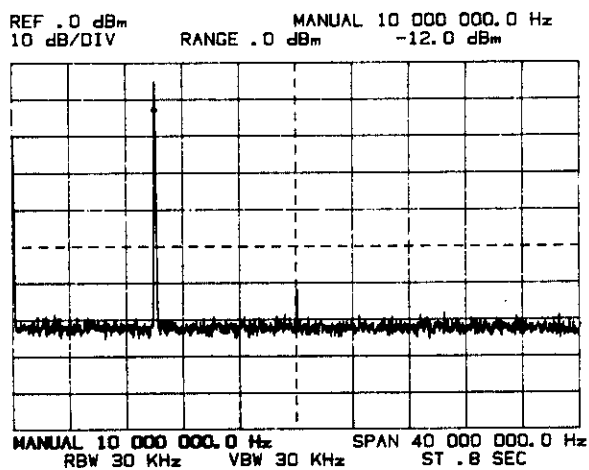







Pressing or selects Manual mode and sets Manual frequency equal to Marker frequency. "MANUAL" readout in top-right corner indicates Manual frequency and real-time signal amplitude at Manual frequency. (The true frequency of the signal is 10.02 MHz rather than 10.00 MHz. To measure its peak amplitude, the Manual frequency must be fine tuned to 10.02 MHz. This can be done with .)

SETTING THE MANUAL FREQUENCY

Independent Marker Tuning

Independent Marker Tuning

Once the desired Manual frequency has been selected, the Marker can be independently tuned with  and . When the Marker is moved away from the Manual measurement point, the readout reverts to "MARKER" to indicate the Marker's frequency and amplitude on the CRT trace. The Manual measurement point continues to be updated to reflect the signal amplitude at the Manual frequency; but the CRT trace is *not updated* at the Marker frequency. The Marker amplitude readout indicates the Marker's amplitude on the trace that is retained on the CRT and may, therefore, be totally unrelated to the input-signal amplitude. When the Marker is moved back to the Manual measurement point, the readout returns to "MANUAL" to indicate the Manual frequency and amplitude. To quickly tune to a signal of interest in the Manual mode, activate  and set the Marker to the approximate frequency using . Then press  or activate  to set the Manual frequency equal to the Marker frequency. Fine tune to the peak of the signal with . Here is an example:

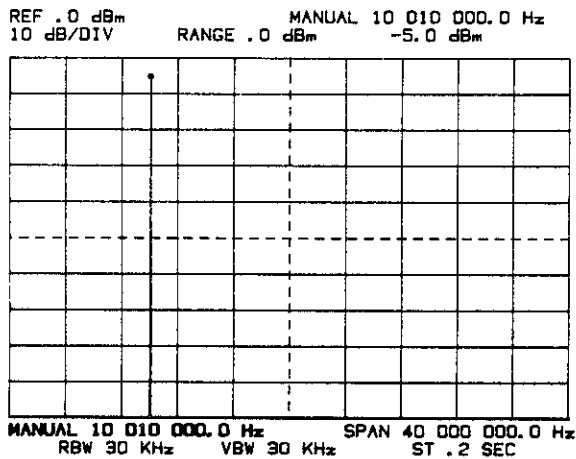

a. Measure Fundamental.

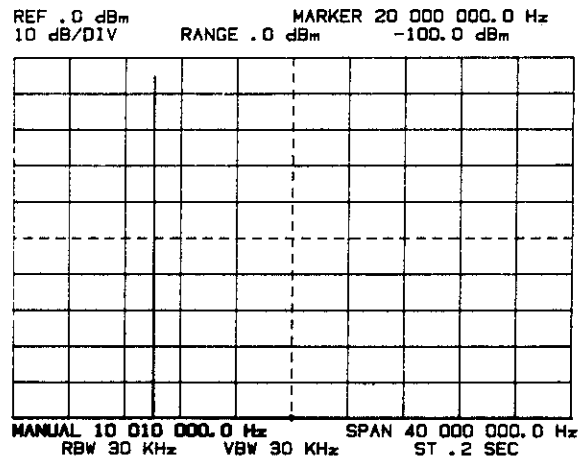

b. Move Marker to approximate frequency of second harmonic with  .

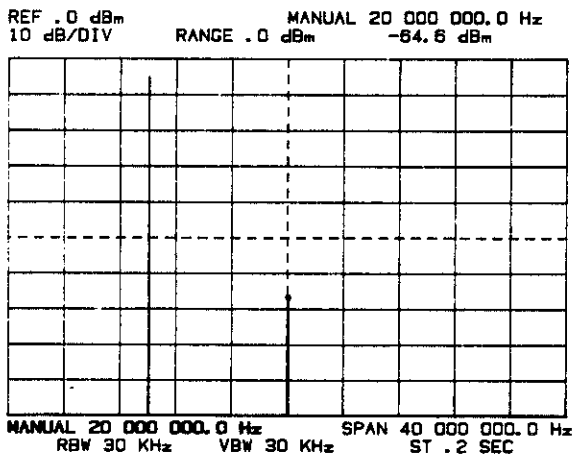

c. Press  or activate  to set Manual frequency equal to Marker frequency.

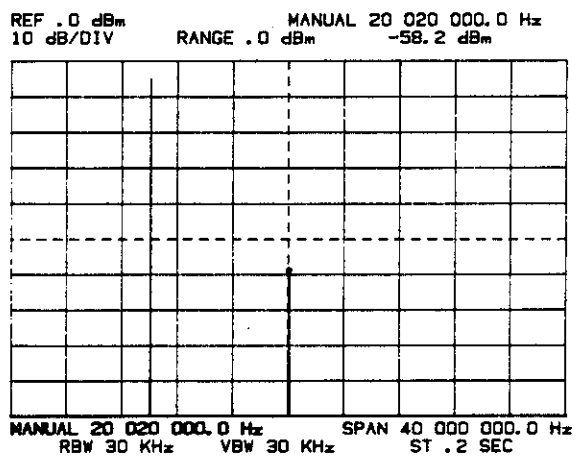

d. Fine tune to peak of second harmonic response with .

Offset Measurements

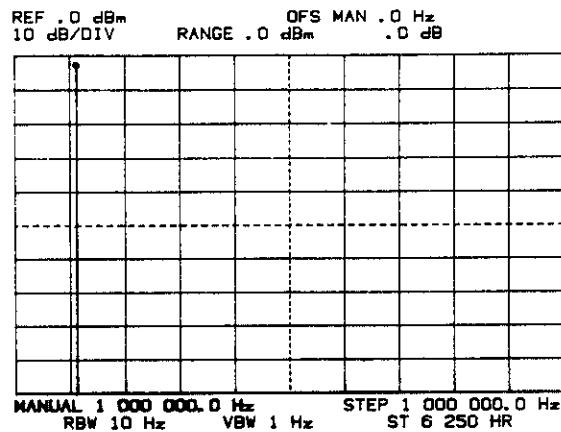

The  function can be used in the Manual mode to measure the relative frequency and amplitude between two signals. For example, to measure the amplitude of a harmonic in "dB" relative to the fundamental:



- a. Tune to the peak of the fundamental.

Set the CF Step Size equal to the fundamental (i.e., Manual) frequency by pressing  or by Numeric Entry.



MWR OFS
→STEP

Activate  and then press .

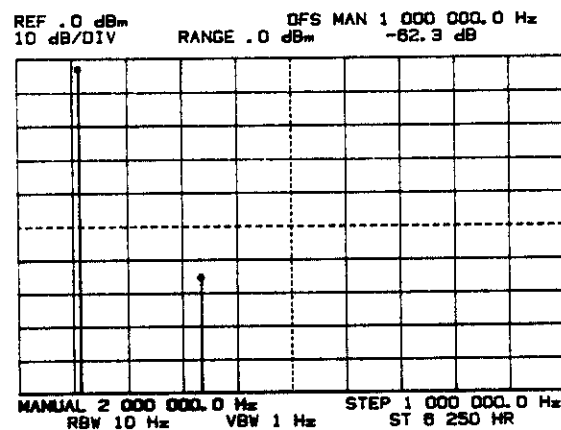
(This stores the current Manual frequency and amplitude in the Offset Register.)



- b. Step to the second harmonic by pressing  



(A stationary Marker remains at the peak of the fundamental response; i.e., the point where  pressed. The "OFS MAN" (Offset Manual) readout indicates the difference between the current Manual frequency and the frequency in the Offset Register. The amplitude readout indicates the harmonic's amplitude in "dB" relative to the amplitude in the Offset Register which, in this case, is the amplitude at the peak of the fundamental response.)

Using The Counter In The Manual Mode

When the instrument is in the Manual mode and the  function is activated, the "COUNTER" frequency is displayed in place of the "MANUAL" or "MARKER" frequency in the upper right-hand corner of the CRT screen. Counter readings are updated continuously at a rate proportional to the Counter period.

NOTES

1. If you wish to display the Manual frequency and Counter frequency simultaneously, preface the Manual frequency by pressing . The highlighted Manual frequency will then appear in the lower left-hand corner of the CRT screen.

2. Tuning the Manual frequency or Marker with  or  and , overrides the Counter, causing the readout to display "MANUAL" or "MARKER". When the tuning stops, the frequency of the input signal about the Manual or Marker frequency is counted and then the "COUNTER" frequency reappears in place of "MANUAL" or "MARKER".

There are two basic ways to make Counter measurements in the Manual mode:

- a. At the Manual frequency with the Marker at the Manual measurement point.
- b. At the Marker frequency with the Marker independently tuned away from the Manual measurement point.

Marker At Manual Measurement Point

When the Marker is at the Manual measurement point, the Counter reading indicates the absolute frequency of the input-signal component about which the analyzer is tuned. To obtain an accurate, stable counter reading, the signal amplitude at the Manual measurement point must be at least 20 dB above the noise and at least 20 dB above any unresolved signal that is inside the IF filter skirts.

To accurately measure the amplitude of a signal in the Manual mode, the Manual frequency must be set almost exactly equal to the frequency of that signal. This is particularly important when a narrow Resolution Bandwidth is being used. For instance, if the Resolution Bandwidth is 3 Hz, and the Manual frequency is ± 1.5 Hz away from the signal, the amplitude reading will be about 3 dB too low.

One convenient way to precisely tune to the peak of a response is to first set the Manual frequency approximately equal to the signal frequency, measure the signal frequency using the Counter and then set the Manual frequency equal to the Counter frequency. This can be done by Numeric Entry or by simply pressing .* In many cases, a relatively wide Resolution Bandwidth can be used to quickly locate, count and tune to the signal of interest. Once the analyzer is tuned to the true signal frequency, the Resolution Bandwidth can be narrowed to obtain the required resolution and sensitivity.

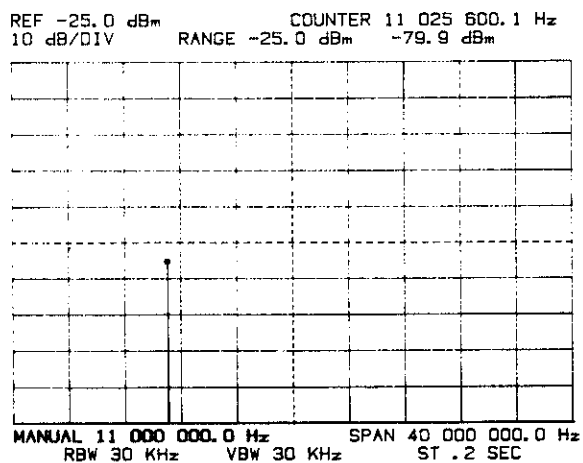



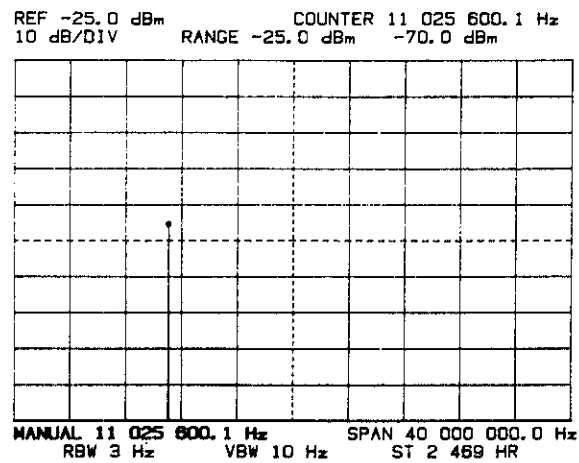

Signal quickly located and counted using 30 kHz RBW.



Manual frequency set equal to Counter frequency; signal measured with 3 Hz RBW.

Tuning To The Peak Of A Response Using The Counter



Another technique that can be used to quickly tune to the peak of a response is:



- a. Set the Manual frequency approximately equal to the signal frequency.
- b. Activate  to accurately measure the signal frequency.
- c. Press  to set the Center-Frequency Step Size equal to the Counter frequency.
- d. Set the Manual frequency to 0 Hz Numeric Entry.
- e. Press  .

*In the Manual mode, the  key sets the Center Frequency equal to the absolute Marker, Counter or Manual frequency (whichever is being displayed). It also sets the Manual frequency equal to the Center frequency and places the Marker at the Manual measurement point. Therefore, if the Counter function is activated, the Manual frequency is set equal to the Counter frequency and is displayed at the Center Frequency point on the CRT screen.

MEASUREMENTS

Marker Not At Manual Measurement Point

When  is activated and the Marker is tuned away from the Manual measurement point (using  ), the instrument's frequency tuning internally alternates between the Manual frequency and the Marker frequency. At the Manual frequency, the Manual measurement point on the CRT trace is updated to reflect the real-time input-signal amplitude. At the Marker frequency, the CRT trace is *not updated*; but the analyzer does actually sample the input signal to obtain a valid, real-time Counter reading. If a sufficiently large input-signal response is detected at the Marker frequency, the Counter reading will accurately indicate the frequency of the signal that is producing the response. If there is no input-signal response at the Marker frequency or if the response is too near the noise or is mixed with another signal, the Counter reading will be unstable.

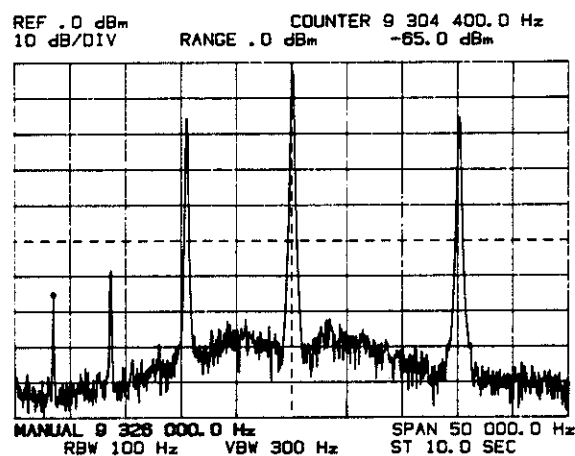

The independent Marker tuning and Counter feature provides a convenient way to count the frequencies of input-signal responses without waiting for successive frequency sweeps. One way to use this feature is to first sweep one time across the input-signal spectrum so that the signals of interest are displayed on the CRT. Then, select the Manual mode (the Manual frequency is arbitrary), activate  and  and tune the Marker to the peaks of the responses that you wish to measure using . (Do not disconnect the input signal or change the amplitude or frequency parameters.) As long as the input-signal spectrum is the same as when the trace was plotted, the real-time Counter readings will indicate the true frequencies of the responses on which the Marker is positioned. The amplitude readout will accurately indicate the Marker's amplitude on the stored CRT trace; but since the trace is not updated at the Marker frequency, the amplitude readout will not reflect any real-time changes in the input-signal amplitude.





Signals of interest can be quickly measured in Manual mode using



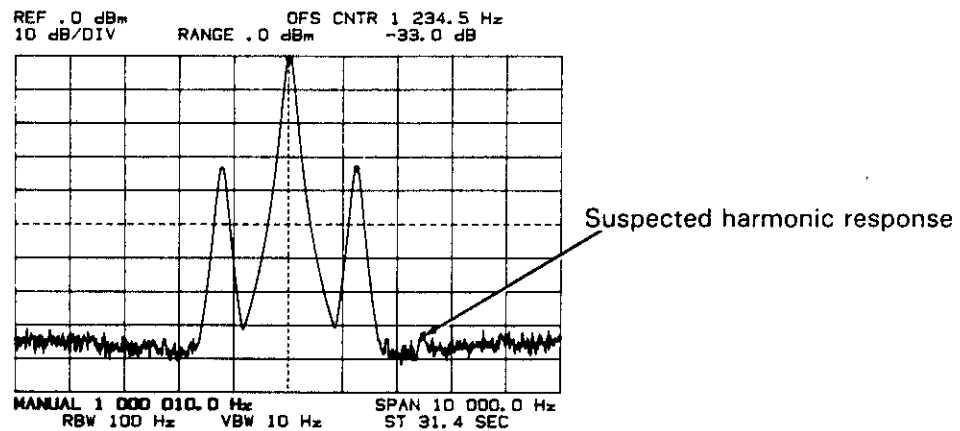

Offset Counter Measurements



The  function can be used in conjunction with the  function to count the frequency difference between two signals. For example, to count the difference between a modulated carrier and its upper sideband:



Set the Marker to the peak of the carrier response with  .



Select the Manual mode by pressing  or activating .

Activate  to count the carrier frequency.

Activate  and then press .

(This stores the counted carrier frequency in the Offset Register.)

Activate  and set the Marker to the peak (or skirt) of the upper side frequency. The "OFS CNTR" (Offset Counter) reading indicates that the difference frequency is 1.2345 kHz.

A close examination of the swept display (above) reveals the presence of what appears to be a harmonic response at about 1.2 kHz above the upper side frequency. It may be a harmonic or it may be a noise spike. One way to tell for sure is to narrow the RBW and VBW and measure it in the Manual mode. This could be done by setting the Marker to the peak of the apparent harmonic, narrowing the Bandwidth and fine tuning with  and . However, this would be a rather tedious process especially if the "response" turns out to be a noise spike. A faster, more accurate way to tune to the harmonic frequency is to set the Step Size equal to the modulating frequency indicated by the "OFS CNTR" reading and increment the Manual frequency to the second harmonic. The procedure is as follows:

MEASUREMENTS

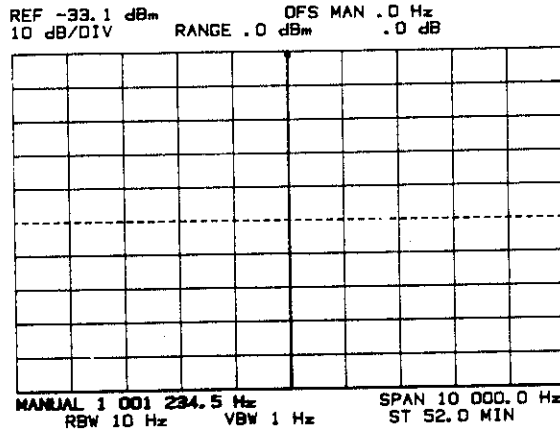

- a. With the Marker still at the peak of the upper side frequency, set the CF Step Size equal to the difference frequency by pressing .

(This sets the Step Size equal to the "OFS CNTR" reading.)

Press .

(This sets the Center Frequency and Manual frequency equal to the absolute Counter frequency; i.e., the upper side frequency.)

Clear the trace by pressing .

Narrow the RBW and VBW to the desired settings.

Move the response to the top of the screen by pressing .

Deactivate .

(The Counter is no longer needed and the harmonic is too low in level to be measured with the Counter.)

Press .

(This allows the harmonic to be measured in "dB" relative to the upper side frequency rather than the carrier.)

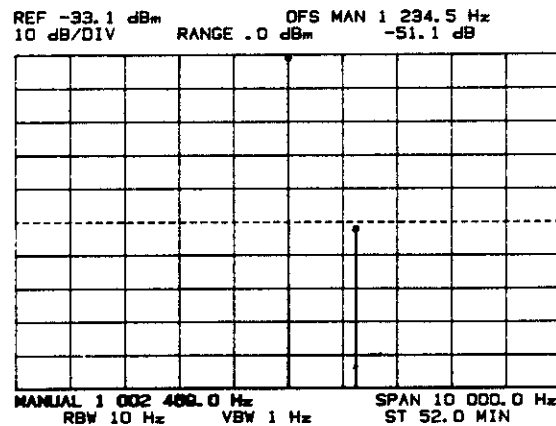



- b. Step to the second harmonic by pressing  .

(The harmonic is definitely present and is 51.1 dB below the fundamental.)

Using The Noise Level Function

In the Manual mode with the  function activated, noise readings are repetitively calculated and updated at a rate proportional to the Noise measurement time. Noise measurement times range from approximately 0.3 seconds (30 kHz RBW) to 33 seconds (3 Hz RBW). While a noise reading is being calculated, the suffix of the current amplitude or noise level reading is displayed brighter than normal. At the end of each noise calculation, there is a time delay of approximately 0.5 seconds during which the readout is updated and the suffix returns to normal brightness to indicate that a valid noise reading is available. The CRT trace at the Manual measurement point is also updated during this 0.5 second period. The trace is not updated during a noise calculation.

Noise level readings are displayed in place of the Manual or Marker amplitude in the upper right-hand corner of the CRT screen. They are displayed in the same units as the Reference Level; i.e., "dBm (Hz)", "dBV(Hz)" or " $V \sqrt{Hz}$ ". Offset noise level readings are displayed in "dB (Hz)". The noise level readings indicate the absolute (or relative) rms random noise spectral density at the Manual or Marker frequency, normalized to a 1 Hz noise power bandwidth.



The  function operates in much the same manner as the  function. It can be used with the Marker at the Manual measurement point or with the Marker tuned away from the Manual measurement point:

- a. When the Marker is at the Manual measurement point, noise readings are calculated according to the real-time input-signal amplitude at the *Manual* frequency.
- b. When the Marker is not at the Manual measurement point, noise readings are based on the real-time signal amplitude at the *Marker* frequency. At the end of each noise calculation, the CRT trace is updated at the Manual measurement point; but the trace is *not updated* at the Marker frequency. In the absence of a noise reading, the Marker readout will indicate the Marker's amplitude on the CRT trace which may be totally unrelated to the real-time signal amplitude from which the noise readings are calculated.



MEASUREMENTS

Noise Measurement Techniques

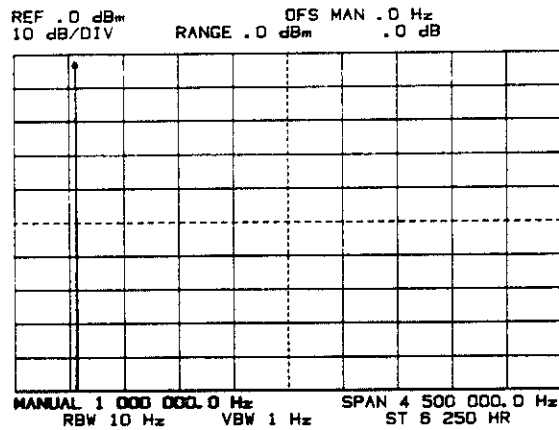

Absolute noise-level measurements can be performed by simply setting the Manual frequency or Marker to the frequency of interest and activating the  function.

The  function can be used in conjunction with the  function to measure signal-to-noise ratio. Here is an example:

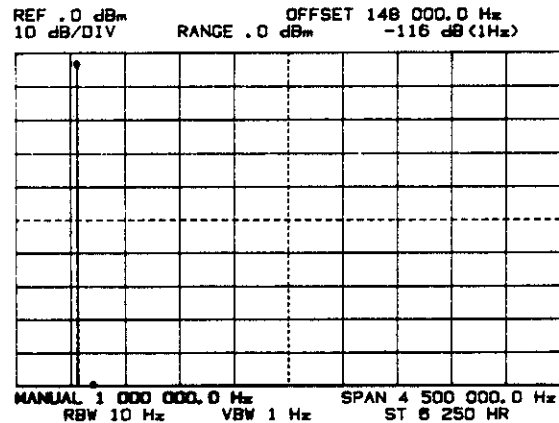

- a. Tune to the peak of the signal. Activate  and then press .







- b. Activate  and set the Marker to the noise measurement frequency with .



Activate  and allow time for the "dB" (1 Hz)" reading to appear.



(The "OFFSET" frequency readout indicates the difference between the current Manual frequency stored in the Offset Register and the Marker frequency. The "dB (1 Hz)" reading indicates the rms random noise spectral density (at the Marker) in a 1 Hz bandwidth *relative* to the signal amplitude in the Offset Register.)

Step The Manual Frequency To Measure Equally Spaced Signals

Pressing   OR  changes the Manual frequency in steps equal to the Center Frequency Step Size. The Center Frequency Step Size is settable within the range of 0 Hz to 40.1 MHz with 0.1 Hz resolution. It can be changed by Marker/Offset Entry, Step Entry or Numeric Entry:

Marker/Offset:  Sets CF Step Size equal to current Manual, Marker, Counter or Offset frequency (whichever is being displayed).

Step Entry:    Changes CF Step Size to next value in a 1, 2, 5, 10 sequence.

Numeric Entry:   Selects specific step size; 0 Hz to 40.1 MHz, 0.1 Hz resolution.

The ability to step the Manual frequency makes it possible to quickly measure equally spaced signals within a specific frequency span. This is especially useful for individually measuring the harmonic components of a complex signal over a wide frequency span or for measuring low-level harmonic distortion products in a narrow bandwidth to maximize the noise-free dynamic range. Here are some examples:

Measuring Equally-Spaced Signals Over A Wide Frequency Span

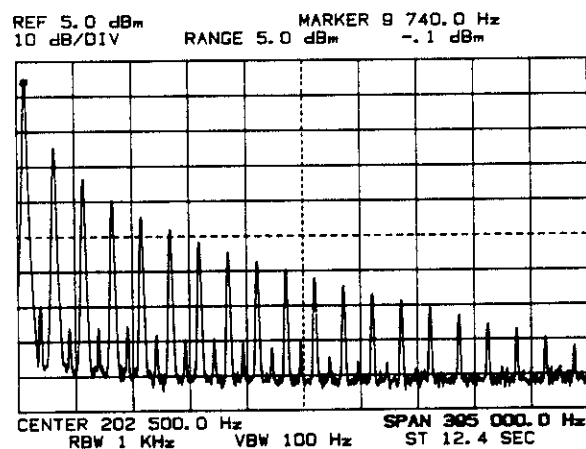





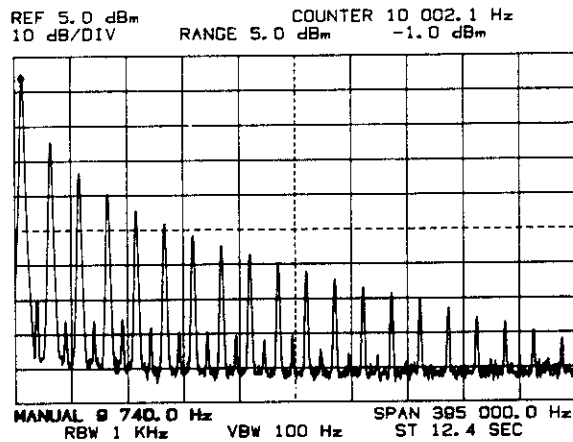

A single sweep over a 395 kHz Span displays the harmonic components of a 10 kHz triangle waveform. With the Resolution Bandwidth set to 1 kHz, many of the low-level even harmonics are too near the noise floor to be measured accurately. In the Manual mode, the harmonics can be individually measured using a narrow bandwidth.

STEP MANUAL FREQUENCY

Measuring Equally-Spaced Signals

To individually measure the harmonics in the Manual mode, proceed as follows:



- a. Set the Marker to the peak of the fundamental with  .
- Select the Manual mode by pressing  or activating .
- Activate  to precisely measure the fundamental frequency.

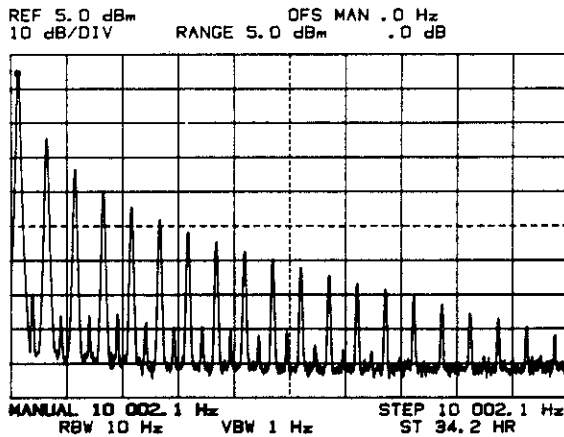



- b. Set the Manual frequency exactly equal to the Counter frequency by Numeric Entry.

Set the CF Step Size equal to the Counter frequency by pressing  or by Numeric Entry.

Deactivate .

Narrow the RBW to reduce the internal noise level. For good video averaging, set the VBW to 10% (or narrower) of the RBW.

(Narrowing the RBW one step reduces the internal noise level by about 4.5 dB.)

To measure the succeeding harmonics in "dB" relative to the fundamental, activate  and press .

STEP MANUAL FREQUENCY

Measuring Equally-Spaced Signals

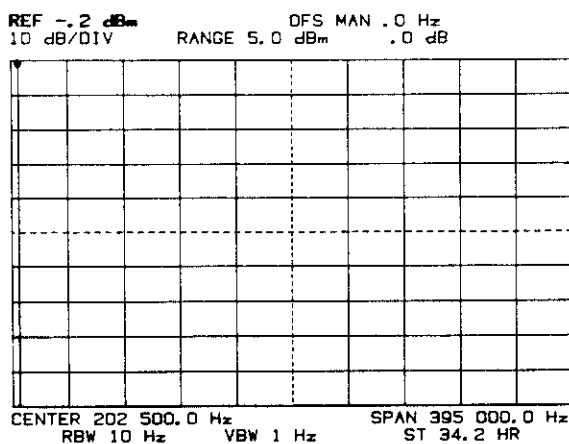

c. Clear the trace by pressing .

Move the fundamental to the top of the screen by pressing .

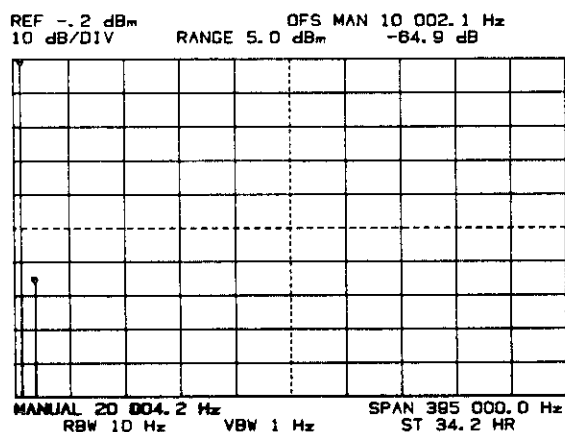

(The trace is no longer needed so it is best to clear it from the screen. If you wish to retain the trace on the screen, you may omit the clear operation. If the trace is needed for future reference, store it in "B" by pressing .)

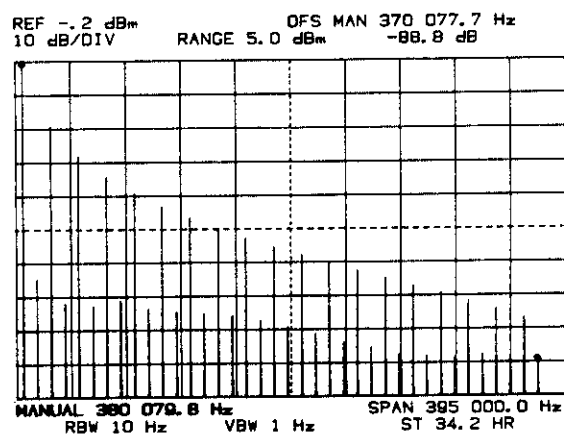

Second Harmonic



.....38th Harmonic

d. Press   to display and measure succeeding harmonics.

STEP MANUAL FREQUENCY
Measuring Harmonic Distortion



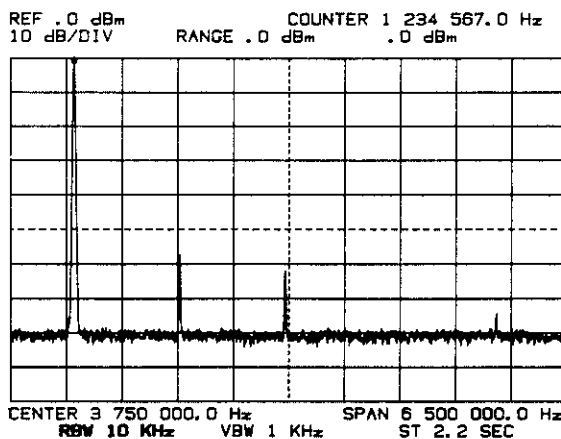



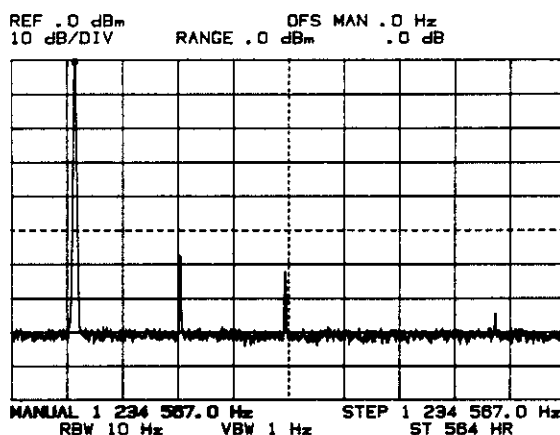

Measuring Low-Level Harmonic Distortion



A single sweep with a 10 kHz RBW clearly shows the second and third harmonics of a 1.2 MHz signal. The fifth harmonic is visible but near the noise floor and the fourth harmonic is well below the noise. Narrowing the RBW to 10 Hz will reduce the noise by about 30 dB, enabling the fourth harmonic to be measured. All five harmonics can be quickly measured with a 10 Hz RBW by stepping the Manual frequency.

Here is the procedure:





- a. Set the Marker to the peak of the fundamental with  .
- Select the Manual mode by pressing  or activating .
- Activate  to precisely measure the fundamental frequency.
- Set the Manual frequency equal to the Counter frequency by Numeric Entry.
- Set the CF Step Size equal to the Counter frequency by pressing  or by Numeric Entry; then, deactivate .
- Narrow the RBW to 10 Hz and the VBW to 1 Hz.
- Activate  and press .

NOTE

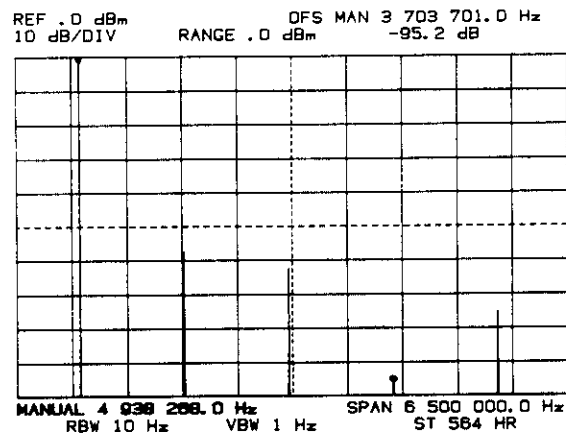
When measuring second and third harmonic distortion products that are more than 80 dB below the fundamental; or IM distortion products that are more than 70 dB below the larger of the two driving signals, increment the RANGE to optimize the distortion-free dynamic range (see Chapter 2, Page 31). In this particular example, the second and third harmonics are well above the analyzer's internal distortion level.



- b. Clear the trace by pressing .





Step the Manual frequency to measure individual harmonics by pressing  .

(The fourth harmonic is 95.2 dB below the fundamental.)

STEP MANUAL FREQUENCY

Measuring Harmonic Distortion

After measuring a signal in the Manual mode, it is sometimes desirable to “zoom-in” on that signal and observe it with a frequency sweep. To accomplish this:

- Step the Manual frequency to the signal of interest.
- Move the signal to the center of the screen by pressing  .
- Narrow the Frequency Span about the Center Frequency to obtain the desired frequency display range (and a reasonable Sweep Time).
- If necessary, lower the Reference Level to display the signal and noise on the CRT screen (or press  to move the signal to the top of the screen).
- Activate the  or  SWEEP function.

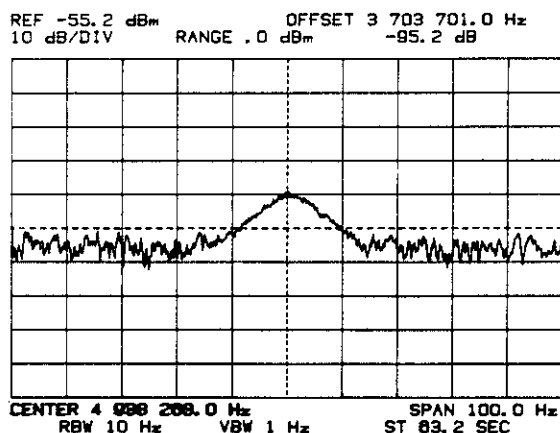

Fourth harmonic of 1.2 MHz signal measured in Manual mode (preceding example) moved to center of screen and displayed with 100 Hz Span. Reference Level lowered to -55.2 dBm to display the signal and noise on the CRT screen. (With the Reference Level at its original setting of 0 dBm, the noise is below the bottom graticule line and is not displayed.)

Other harmonics can be moved to the center of the screen and displayed in the same span by simply incrementing or decrementing the Center Frequency. The Center Frequency steps are equal to the Manual frequency steps.

For example:

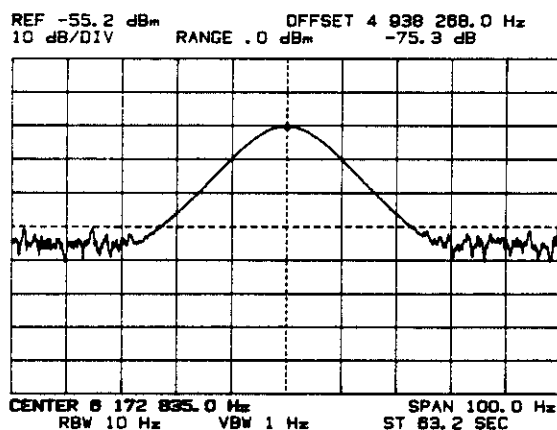

displays the fifth harmonic-after a 63.2-second frequency sweep.

Step The Manual Frequency By Stepping The Center Frequency

A change in the Center Frequency produces a corresponding change in the Manual frequency. Therefore, if the Center Frequency is changed, the absolute Manual frequency will also change; but the difference between the Manual frequency and the Center frequency will remain the same. For instance, if the Manual frequency is initially set equal to the Center Frequency and the Center Frequency is changed by 1 kHz, the Manual frequency will also change by 1 kHz and will remain in the center of the screen.



The Manual frequency can be stepped within the limits of the selected Frequency Span; but the Center Frequency can be stepped within the range of 0 Hz to 40.1 MHz regardless of the Frequency Span. By setting the Manual frequency equal to the Center Frequency (or vice-versa) and stepping the Center Frequency, you can measure equally spaced signals over the entire frequency range of the instrument with any arbitrary Frequency Span.

To illustrate the concept of stepping the Center Frequency to measure equally spaced signals in the Manual mode, we will give two examples. The first is a repeat of the harmonic distortion measurement previously made by stepping the Manual frequency. The second example shows a very rapid technique for measuring the intermodulation (IM) distortion products of two closely spaced signals.

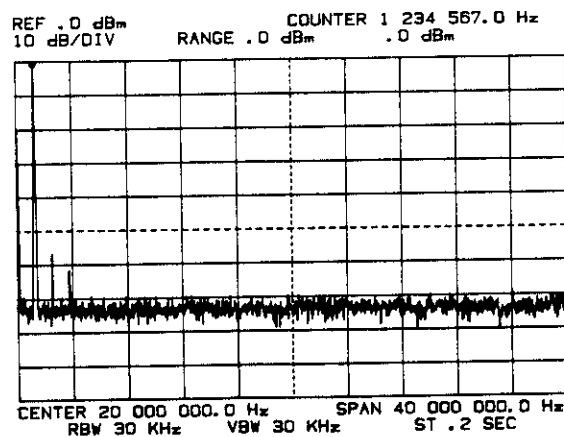
Measuring Harmonic Distortion By Stepping The Center Frequency



- a. Start with a full Span by pressing .

Set the Marker to the peak of the fundamental with  .

(If the fundamental is masked by the zero response, decrement the Stop Frequency until the fundamental response is distinguishable.)

Activate  to precisely measure the fundamental frequency.

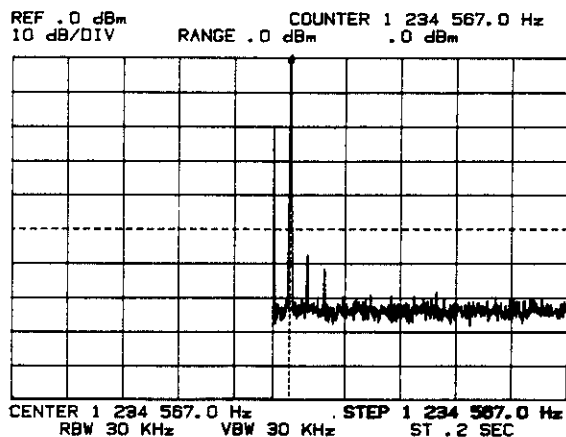

STEP CF
Measuring Harmonic Distortion



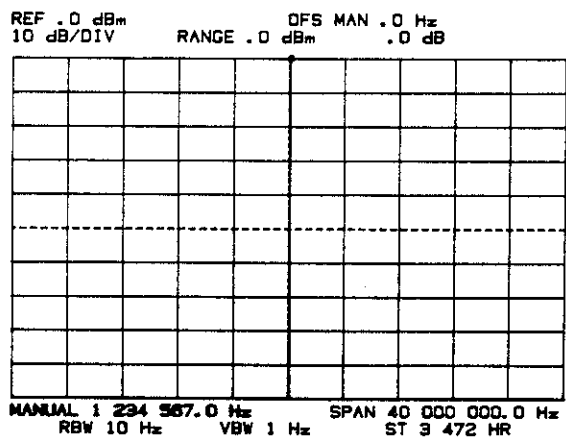

- b. Set the Center Frequency equal to the Counter frequency by pressing .

Set the CF Step Size equal to the Counter frequency by pressing .



- c. Select the Manual mode by pressing  or activating .



(This sets the Manual frequency equal to the Marker frequency which, after , is equal to the Center Frequency.)

Clear the Trace by pressing .

Narrow the RBW to 10 Hz and the VBW to 1 Hz.

(The 3 Hz RBW would provide a lower noise level than the 10 Hz RBW. In this case, however, the 10 Hz RBW provides adequate sensitivity and further allows a 10:1 RBW/VBW ratio. This gives better noise averaging than the 3:1 ratio that would be obtained with a 3 Hz RBW.)

Deactivate .

To measure the harmonics in "dB" relative to the fundamental, activate  and then press .

STEP CF
Measuring Harmonic Distortion

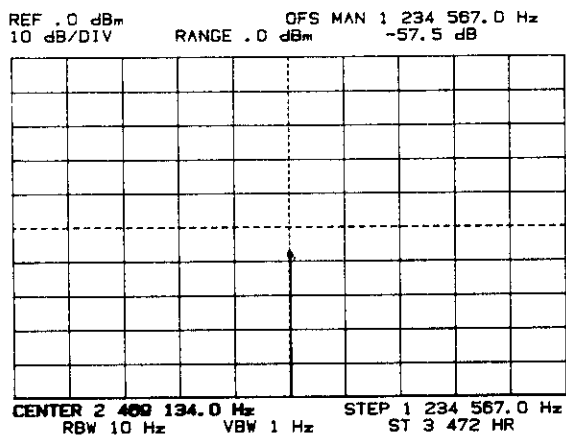

d. Press   to measure the second harmonic.

(The "OFS MAN" (Offset Manual) frequency readout indicates the difference between the fundamental frequency stored in the Offset Register with  and the current Manual frequency.)

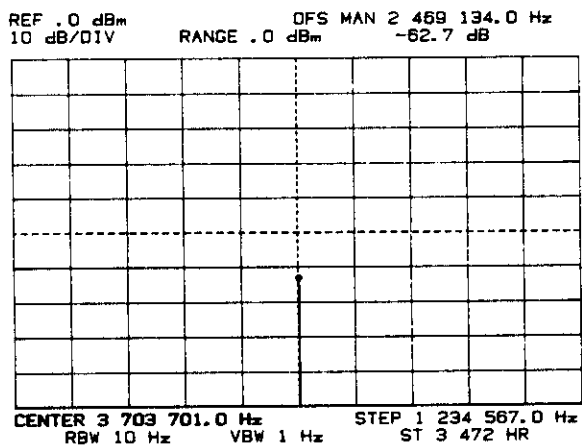

Third Harmonic

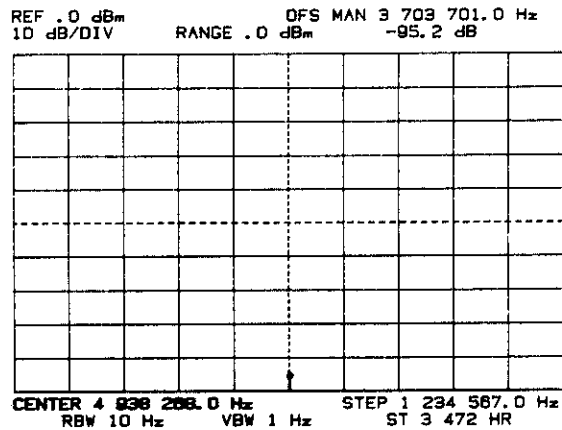

Fourth Harmonic

e. Press  to measure succeeding harmonics.

(Starting with , an experienced operator can measure all five harmonics in less than one minute using this procedure.)

STEP CF

Measuring IM Distortion

Stepping The Center Frequency To Measure IM Distortion Products.

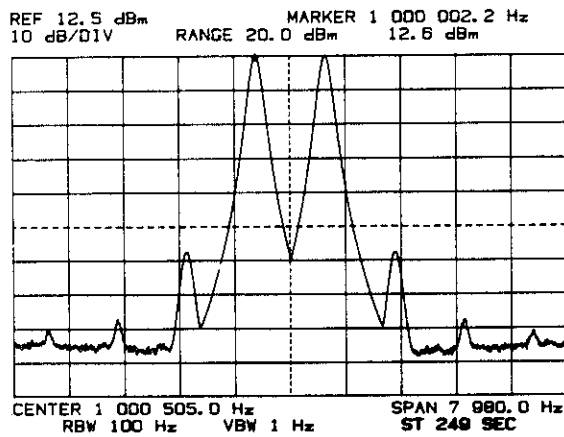

Driving Signals and Odd-Order IM Distortion Products.

Figure A

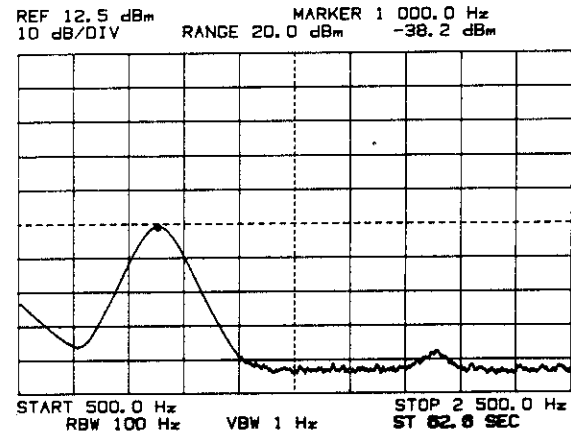

Second and Fourth-Order IM Distortion Products.

Figure B

A 249-second sweep (Figure A) displays the odd-order (i.e., 3rd, 5th and 7th) IM distortion products generated by a high-frequency amplifier that is driven by two 12.6 dBm signals. The signals are about 1 kHz apart; the lower driving frequency is 1 MHz and the upper driving frequency is about 1.001 MHz.

Another frequency sweep (Figure B) displays the even-order (i.e., 2nd and 4th) IM products which appear at 1 kHz and 2 kHz, respectively.

The total time required to complete the IM distortion measurement with two frequency sweeps (counting setup time, etc) is about seven minutes. In the Manual mode, however, the IM distortion products can be individually measured in about 2.5 minutes starting from full Span. Here is the procedure:

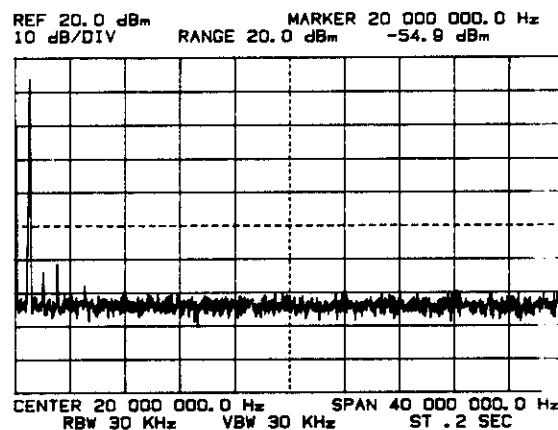



- Start with a full Span by pressing .

(The full span and 30 kHz RBW does not provide the resolution needed to separate the two closely spaced signals; so they appear as one response.)

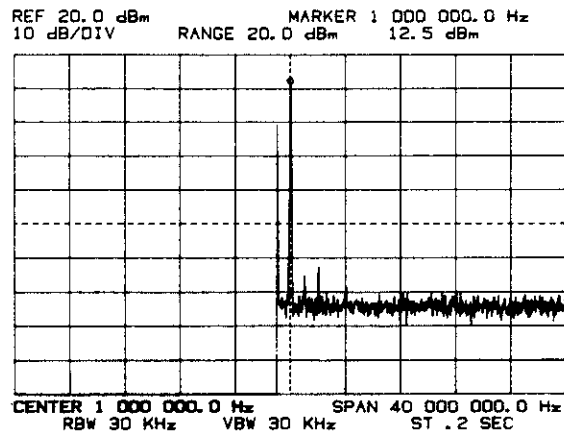
STEP CF
Measuring IM Distortion



b. Set the Marker to the peak of the large response with .

Move the response to the center of the screen by pressing .

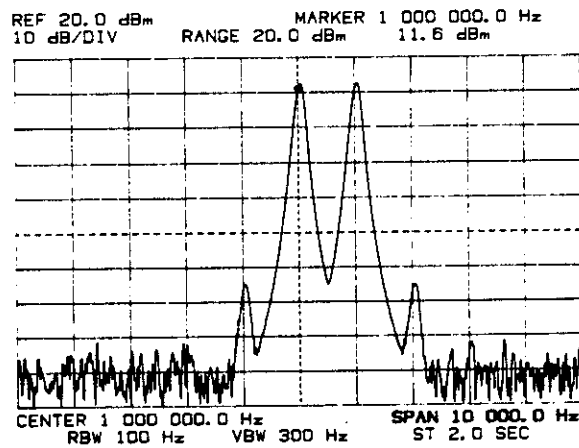

c. Narrow the Frequency Span (with  ) just enough to resolve the two driving signals.

STEP CF
Measuring IM Distortion

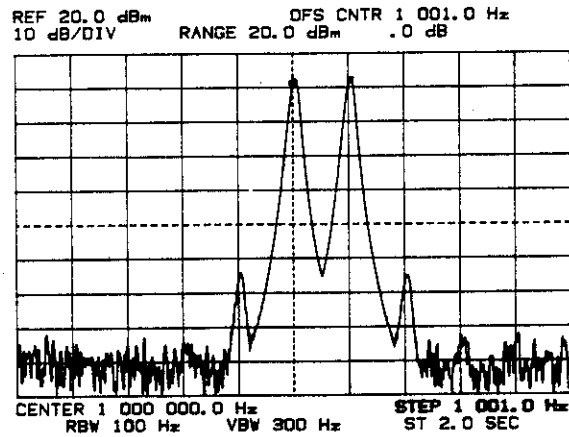

- d. Select the Manual mode by pressing or activating .

(This sets the Manual frequency equal to the Marker frequency which is near the peak of the 1 MHz driving signal.)

Activate to precisely measure the frequency of the lower driving signal on which the Marker is positioned.

Activate and then press .

(This stores the counted frequency of the lower driving signal in the Offset Register.)

Activate and set the Marker to the peak of the upper driving signal with .

(The "OFS CNTR" (Offset Counter) reading indicates the difference between the frequency of the lower driving signal in the Offset Register and the counted frequency of the upper driving signal.)

Set the CF Step Size equal to the difference frequency (i.e., "OFS CNTR" frequency) by pressing .

STEP CF
Measuring IM Distortion

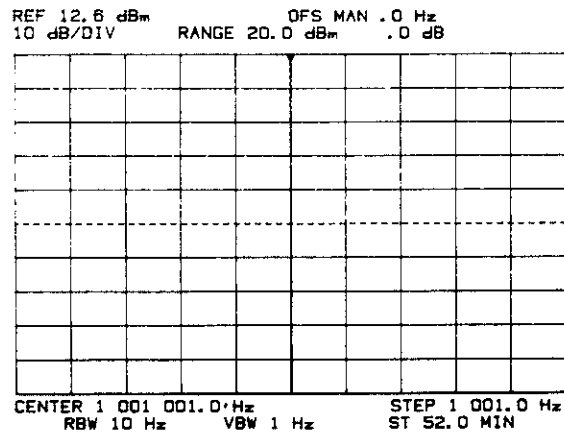

e. Press .

(This sets the Center Frequency and Manual frequency equal to the absolute Counter frequency which is the frequency of the upper driving signal.)

Clear the trace by pressing .

Narrow the RBW and VBW to the desired settings.

Move the response to the top of the screen by pressing .

Deactivate .

To insure an accurate offset reference, press .

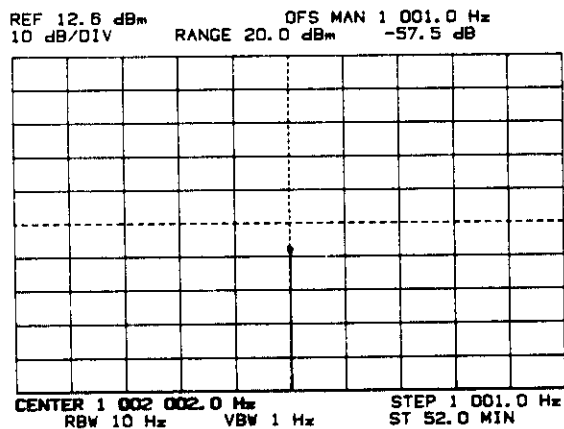

Third Order

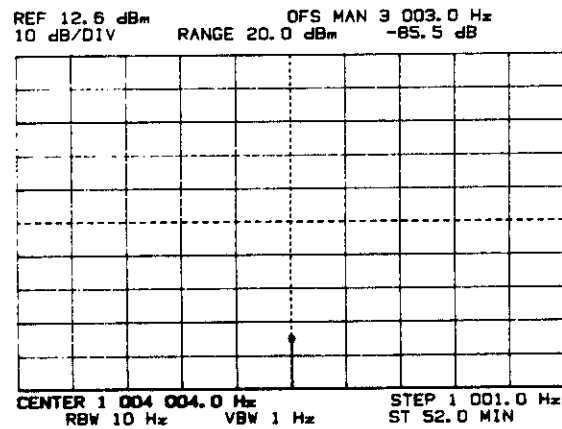

...Seventh Order

f. Increment the Center Frequency () to individually measure the odd-order IM products in the region above the upper driving signal.

(Since the IM distortion products are the same on both sides of the driving signals, it is not normally necessary to measure both sides. If desired, however, the distortion products below the lower driving signal can be measured by decrementing the Center Frequency.)

STEP CF
Measuring IM Distortion

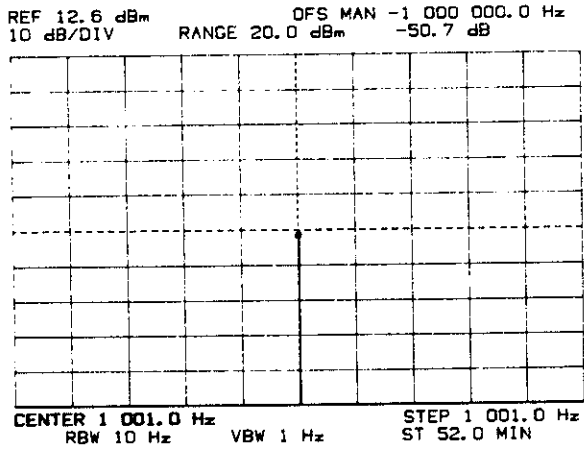

Second Order

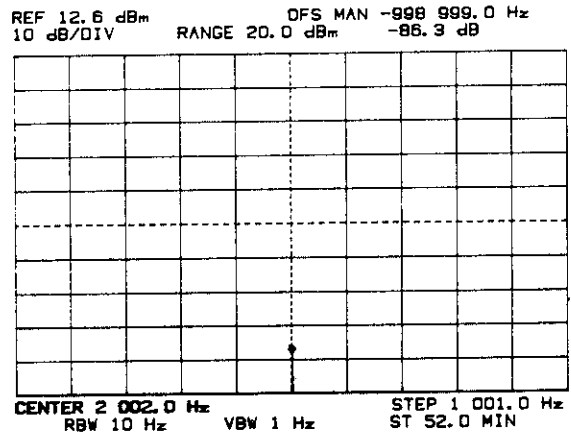

Fourth Order

- g. Set the Center Frequency to 0 Hz by Numeric Entry.

Press



to measure the even-order IM products.

CHAPTER 4

INPUT AND RANGE FUNCTIONS

This chapter describes the 3585's two input channels and the Impedance, Range and Reference-Level Track functions located in the INPUT control block.

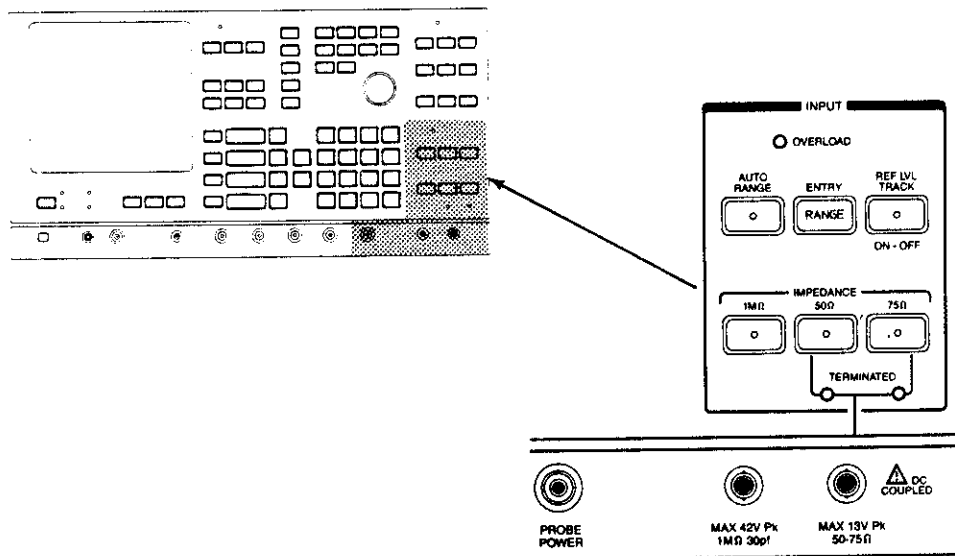

INPUTS

INPUTS

The 3585 has two input channels:

Terminated (50 Ω or 75 Ω)

High Impedance (1 M Ω < 30 pF)

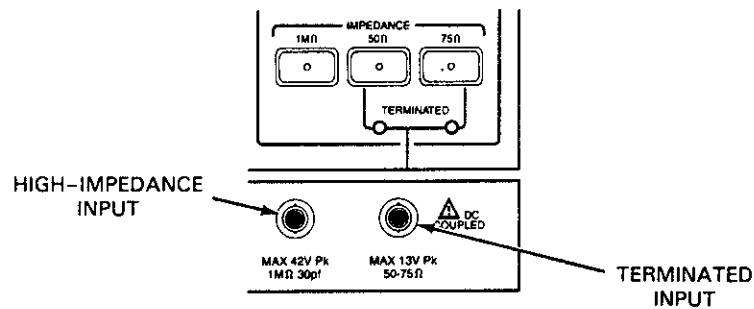

The inputs are mutually exclusive and, therefore, cannot be used simultaneously.

NOTE

To avoid crosstalk interference between input channels, it is good practice to disconnect the signal source from the input that is not being used; i.e., if you are using the Terminated input leave the High-Impedance input disconnected and vice-versa. (Interchannel isolation typically ranges from about 104 dB at 20 Hz to 85 dB at 40.1 MHz.)

Both inputs are single ended (unbalanced) and, to minimize ground-loop problems, the outer shells of the female BNC input connectors are connected to a special measurement ground which is isolated at low frequencies. The isolation is provided by a low-resistance saturable-core inductor connected between measurement ground and chassis ground.

Do not, under any circumstances, attempt to float the outer shells of the input connectors above chassis ground.

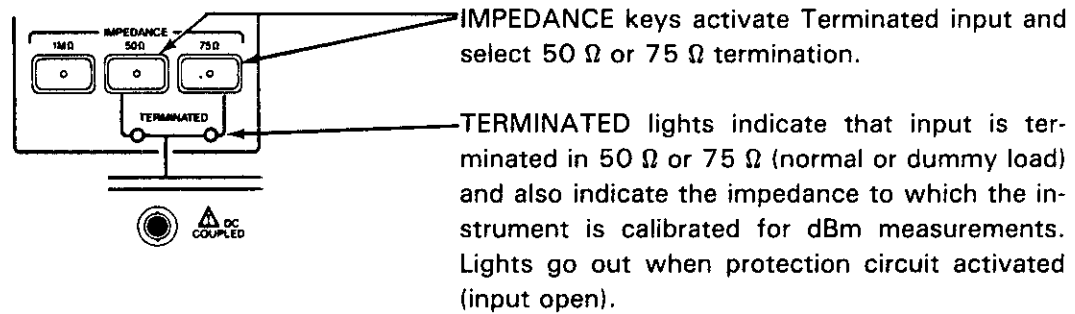

Terminated Input



The Terminated input provides a 50-ohm or 75-ohm (± 1 ohm) resistive termination. The dc-coupled terminating resistance is rated at one watt; specified return loss is > 26 dB.*

CAUTION

The Terminated input is dc coupled. Peak (combined ac/dc) input levels exceeding ± 13 volts will activate the protection circuit but may still damage the input circuitry.

To use the Terminated input simply press  OR .

The IMPEDANCE key will light to indicate that the Terminated input is activated; the TERMINATED light, located directly below the IMPEDANCE key, will light to indicate that the input is terminated. The TERMINATED light that is on indicates the impedance to which the instrument is automatically calibrated for dBm measurements; i.e., dBm/50 Ω or dBm/75 Ω.

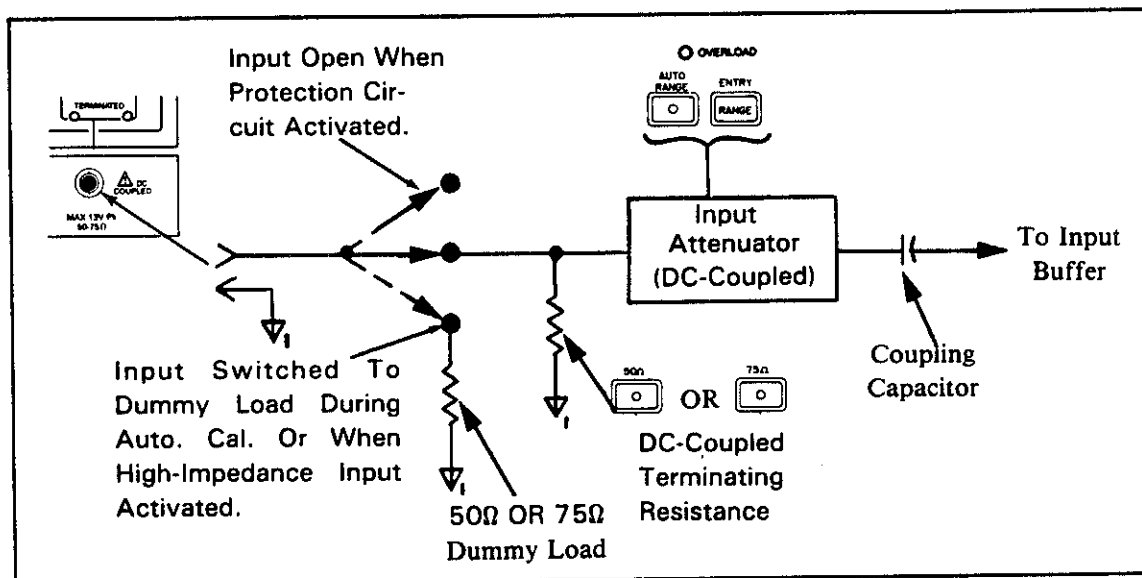

Terminated Input Channel

*When the input is terminated in a dummy load, the return loss is typically > 20 dB.

TERMINATED INPUT

Overvoltage Protection

The Terminated input channel is equipped with an over-voltage protection circuit which automatically opens the input when the peak (combined ac/dc) input level exceeds ± 13 volts.* When the protection circuit activates, the yellow 50 Ω or 75 Ω TERMINATED light goes out, indicating that the input is no longer terminated. (The IMPEDANCE key light stays on.) With the Terminated input open, the instrument cannot respond to the input signal. Consequently, the OVERLOAD light will go out and with the AUTO RANGE function on, the instrument will automatically downrange to -25 dBm.

To reset the protection circuit:

- a. Remove the overload by disconnecting the signal source or reducing the input level.
- b. Press any of the IMPEDANCE keys (including the one currently activated) or press  .

Things To Note Or Observe

- a. The terminating impedance is not displayed on the CRT.
- b. When the dc input voltage is greater than ten times the RANGE setting, the first two amplitude readings after an Automatic Calibration cycle will be incorrect.
- c. When the dc input voltage is greater than 100 times the RANGE setting, the 3585 will not calibrate properly. ("CALIBRATION ERROR 03" will appear on the CRT screen.)
- d. When the 3585 automatically calibrates, the Terminated input is internally switched to a 50 Ω or 75 Ω dummy load. This switching operation, occurring at the beginning and end of each calibration cycle, opens the input for an instant in time causing the input level to increase. The resulting transients do not normally affect the 3585 but they may affect other instruments connected to the signal source in parallel with the 3585. (With a large input-signal level, the transients could potentially activate the protection circuit; but this does not normally occur.)
- e. The 3585 Automatic Calibration system operates through the Terminated input channel regardless of which input is being used. The Terminated input, therefore, provides much higher amplitude accuracy than the High-Impedance input. The Terminated input channel also has lower noise and distortion than the High-Impedance input; so it should be used whenever optimum accuracy and dynamic range is required. Signal sources having output impedances other than 50 Ω or 75 Ω can be connected to the Terminated input through an impedance matching network or high-impedance probe.

*13 volts peak = 9.19 V rms = +19.27 dBV = +32.28 dBm/50 Ω = +30.52 dBm/75 Ω

High Impedance Input

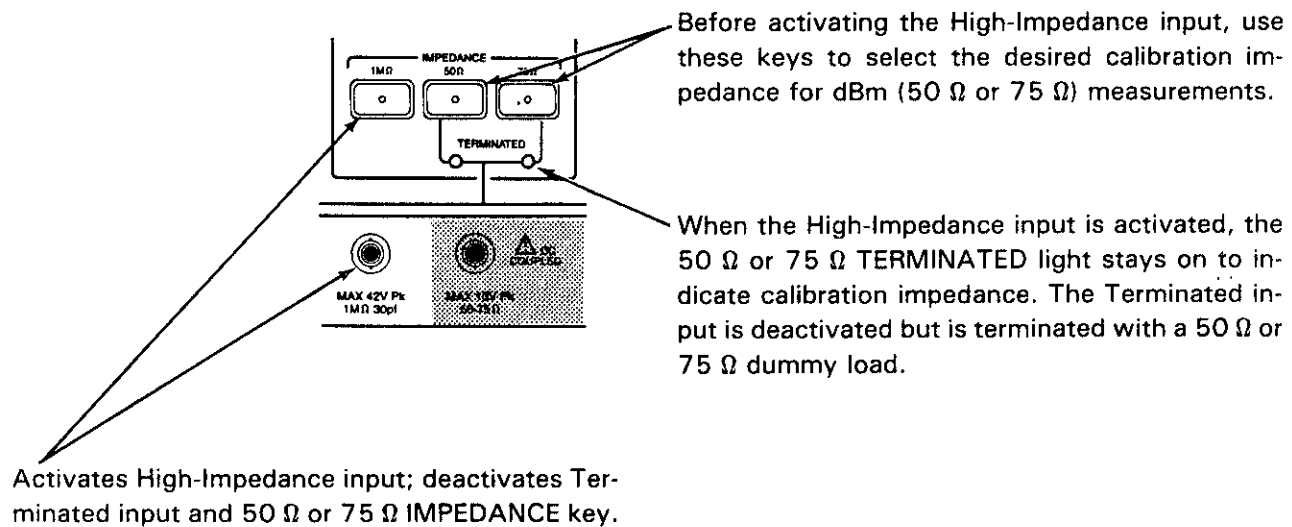







The High-Impedance input is ac coupled and has an input impedance of 1 megohm ($\pm 3\%$) shunted by less than 30 pF. It is intended for general-purpose measurements where optimum amplitude accuracy and dynamic range is not required. The input can be used directly for in-circuit probing of low-frequency devices; it can be bridged across a terminated transmission line or it can be externally terminated to match the output impedance of a specific signal source. The 1 megohm 30 pF input impedance is compatible with several high-impedance 'scope probes such as the -hp- Model 10040A.

CAUTION

RF input levels exceeding those listed in Table 1 may damage the input circuitry. The peak (combined ac/dc) input level applied to the high-Impedance input must not exceed ± 42 volts.

To use the High-Impedance input:

- Select the desired calibration impedance by pressing  OR . (The calibration impedance is the impedance to which the instrument is automatically calibrated for dBm measurements; i.e., dBm/50 Ω or dBm/75 Ω . For measurements in dBV or volts, the IMPEDANCE setting is arbitrary.)
- Activate the High-Impedance input by pressing  .

The  key will light to indicate that the High-Impedance input is activated. The  or  key will go out but the 50 Ω or 75 Ω TERMINATED light will stay on to indicate the calibration impedance and also to indicate that the Terminated input is terminated with a 50 Ω or 75 Ω dummy load.

HIGH IMPEDANCE INPUT

Overvoltage Protection

The High-Impedance input channel is protected by passive circuitry which does not require resetting. As indicated on the 3585 front panel, the High-Impedance input will withstand peak (combined ac/dc) input levels up to ± 42 volts.* However, high-level, high-frequency signals applied over a long period of time may damage the input circuitry. To avoid this possibility, the RF signal level applied to the High-Impedance input must not exceed the maximum ac input levels listed in Table 1. The dc input level must be such that the peak input level does not exceed ± 42 volts.

Table 1. Maximum ac Input Levels (High-Impedance Input).

Frequency Range	Maximum ac Input Level
dc to 5 MHz	± 42 V peak
5 MHz to 10 MHz	± 21 V peak
10 MHz to 20 MHz	± 10.5 V peak
20 MHz to 50 MHz	± 5.25 V peak

CAUTION: Input levels exceeding those listed in this table may damage the input circuitry.

NOTE

When the dc input voltage is greater than ten times the RANGE setting, the first two amplitude readings after an Automatic Calibration cycle will be incorrect.

PROBE POWER JACK

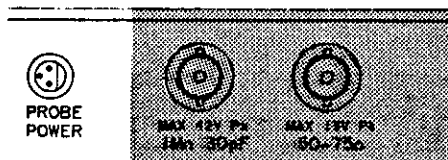

The PROBE POWER jack supplies power for high-impedance 1:1 active probes such as the -hp-Model 1120A 500 MHz AC Probe, which is recommended for use with the 3585. The voltage outputs are +15 V dc and -12.6 V dc, with a maximum current of 150 mA. To preserve the ground isolation feature when an active probe is used, the ground terminal of the PROBE POWER jack is connected to the same isolated measurement ground as the outer shells of the BNC input connectors.

*42 volts peak = 29.69 V rms = 29.45 dBV = 42.46 dBm/50 Ω = 40.70 dBm/75 Ω .

RANGE

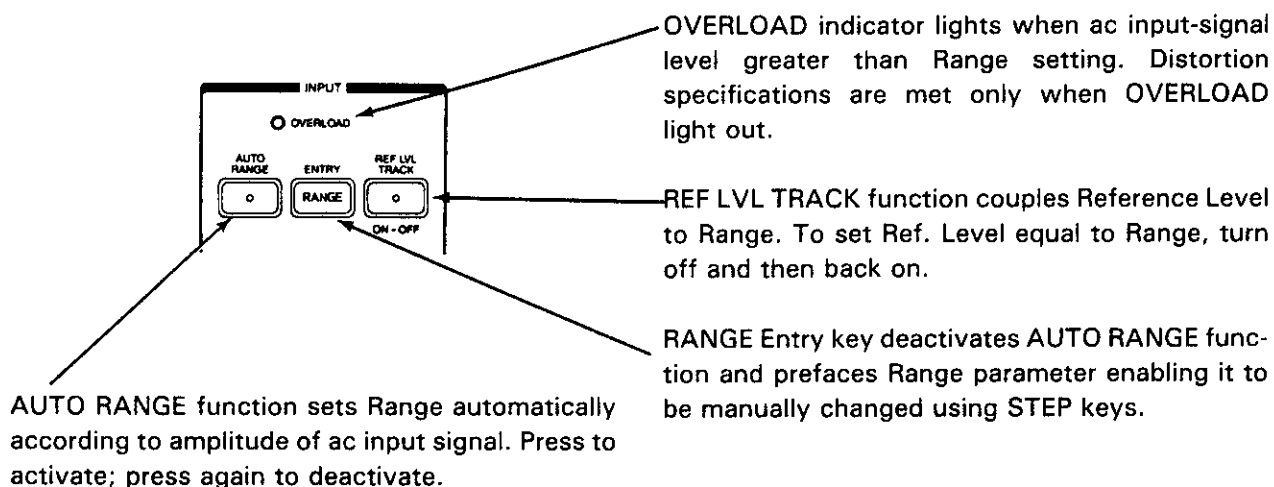

The Range setting determines the maximum ac signal level that can be applied to the Input (i.e., the input currently activated) without overdriving the input circuitry.

The 3585 has a total of twelve Range settings; -25 dBm to $+30$ dBm, selectable in 5 dB increments.

The Range can be set automatically using the AUTO RANGE feature or it can be manually incremented or decremented (in 5 dB steps) using the STEP keys. *The Range cannot be set by Numeric Entry.*

Range Readout

The selected RANGE setting appears in the top middle portion of the CRT screen. It is displayed in dBm (50Ω or 75Ω), dBV or rms volts, corresponding to the units in which the Reference Level (REF) is displayed. Even though the Range setting is displayed on the CRT screen, Range information is not normally needed to make measurements with the 3585.

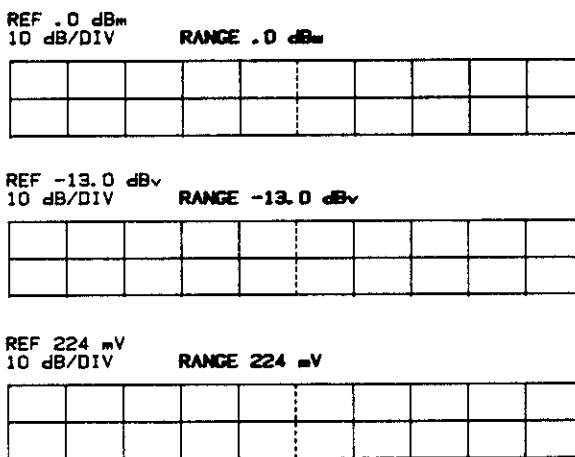

RANGE

Range Settings For Terminated Input

When the Terminated input is activated, the Range settings are defined in dBm/50 ohms or dBm/75 ohms, depending on the terminating impedance:

RANGE (dBm)	50-OHM OVERLOAD LEVEL			75-OHM OVERLOAD LEVEL		
	(dBV)*	(RMS VOLTS)	(PK VOLTS)	(dBV)*	(RMS VOLTS)	(PK VOLTS)
+30.0	+16.99	7.08 V	10.01 V	+18.75	8.68 V	12.27 V
+25.0	+11.99	3.98 V	5.63 V	+13.75	4.86 V	6.87 V
+20.0	+ 6.99	2.24 V	3.17 V	+ 8.75	2.74 V	3.87 V
+15.0	+ 1.99	1.25 V	1.77 V	+ 3.75	1.54 V	2.18 V
+10.0	- 3.01	708 mV	1.00 V	- 1.25	868 mV	1.23 V
+ 5.0	- 8.01	398 mV	563 mV	- 6.25	486 mV	687 mV
+ 0.0	-13.01	224 mV	317 mV	-11.25	274 mV	387 mV
- 5.0	-18.01	125 mV	177 mV	-16.25	154 mV	218 mV
-10.0	-23.01	70.8 mV	100 mV	-21.25	86.8 mV	123 mV
-15.0	-28.01	39.8 mV	56.3 mV	-26.25	48.6 mV	68.7 mV
-20.0	-33.01	22.4 mV	31.7 mV	-31.25	27.4 mV	38.7 mV
-25.0	-38.01	12.5 mV	17.7 mV	-36.25	15.4 mV	21.8 mV

*On the CRT display, the "dBV" Range settings are rounded off to the nearest 0.1 dB; e.g., +16.99 dBV = +17.0 dBV

Range and Overload Levels (Terminated Input)

Range Settings For High-Impedance Input





When the High-Impedance input is activated, the Range settings are defined in dBV (1 V rms = 0 dBV), corresponding to cardinal points on the dBm/50-ohm scale:

RANGE (dBV)*	OVERLOAD LEVEL			
	(dBm/50 OHMS)	(dBm/75 OHMS)*	(RMS VOLTS)	(PK VOLTS)
+16.99	+30.0	+28.24	7.08 V	10.01 V
+11.99	+25.0	+23.24	3.98 V	5.63 V
+ 6.99	+20.0	+18.24	2.24 V	3.17 V
+ 1.99	+15.0	+13.24	1.25 V	1.77 V
- 3.01	+10.0	+ 8.24	708 mV	1.00 V
- 8.01	+ 5.0	+ 3.24	398 mV	563 mV
-13.01	+ 0.0	- 1.76	224 mV	317 mV
-18.01	- 5.0	- 6.76	125 mV	177 mV
-23.01	-10.0	-11.76	70.8 mV	100 mV
-28.01	-15.0	-16.76	39.8 mV	56.3 mV
-33.01	-20.0	-21.76	22.4 mV	31.7 mV
-38.01	-25.0	-26.76	12.5 mV	17.7 mV

*On the CRT display, the Range settings in dBV and dBm/75 Ω are rounded off to the nearest 0.1 dB.



Range and Overload Levels (High-Impedance Input)

Auto Range Operation

Pressing  OR  activates the Auto Range function. Unless you specifically override the Auto Range function by pressing  or deactivating , the 3585 will automatically select the proper Range according to the amplitude of the ac input signal. (The Auto Range circuitry is ac coupled and, therefore, will not respond to a dc input.) The Range that is selected automatically is typically the lowest Range that can be used without overdriving the input circuitry and is referred to as the "optimum" Range setting. For single-tone measurements at the Terminated input, the optimum Range setting will provide at least 80 dB of distortion-free dynamic range. Since the Range is set automatically and Range information is not needed to make measurements, the Range setting can generally be ignored.

Manual Ranging

To manually change the Range setting:

Press  then  OR 

Pressing  deactivates the Auto Range function and prefaces the Range parameter. An "UP" step increases the Range by 5 dB; a "DOWN" step decreases the Range by 5 dB. Step entries do not terminate the entry sequence; so the Range can be stepped any number of times without being reprefaced. Attempts to step above the highest Range or below the lowest Range will cause the beeper to sound and the error message, "OUT OF RANGE" to appear on the CRT screen.

QUESTION:

Since the Range can be set automatically, why have the manual Range capability?

ANSWER:

Two reasons:

1. While the Auto. Range feature is very convenient and certainly a rare commodity on a spectrum analyzer, it is not practical for all measurement applications. For example, auto-ranging cannot be used when measuring intermittent signals or signals that are slowly varying about the Auto. Range threshold. Also, for in-circuit probing applications, it is generally preferable to set the Range manually rather than wait for the instrument to auto. range each time the probe is moved to a different node.
2. The ability to manually change the Range setting makes it possible to optimize the dynamic range according to the type of measurement being performed. When measuring the low-level spurious components or noise of an external source, it is often beneficial to decrement the Range one or two steps below the optimum setting. This overdrives the input and increases the internal distortion; but it also improves the signal-to-noise ratio, making it possible to measure low-level signals that would otherwise be buried in noise. Up-ranging from the optimum setting increases the internal noise level but decreases the internal distortion. By up-ranging and then narrowing the Resolution Bandwidth to reduce the noise, the operator can optimize the distortion-free dynamic range for low-level distortion measurements.

Overload Indicator

Whenever the ac input-signal level is greater than the Range setting, the instrument will uprange (AUTO RANGE on, Range < +30 dBm) or the OVERLOAD indicator will light. An Overload indication simply means that the input circuitry is being overdriven and the internal distortion levels may be higher than specified. As long as the input-signal level does not exceed the maximum input levels listed on the front panel, the inputs may be overdriven up to 12.3 dB above the Range setting. Overdriving improves the signal-to-noise ratio (at the cost of higher distortion) and is a very effective way to optimize the noise-free dynamic range for low-level measurements that are not affected by internal distortion.

Things To Note Or Observe

- a. The Auto Range function cannot be used in cases where the amplitude of the input signal varies slowly above and below the Auto-Range threshold. This commonly occurs during swept frequency response measurements with the 3585 Tracking Generator.
- b. It is normal for the OVERLOAD indicator to flash on and off as the 3585 upranges and downranges in search of the proper Range setting.
- c. The OVERLOAD indicator (and Auto Range function) is controlled by a broadband ac-coupled detector which responds to the composite ac input-signal level. (It does not respond to a dc input.) The OVERLOAD indicator lights (and/or the instrument upranges) when the input-signal level exceeds the Range setting by approximately +0.2 dB. When the input signal is in this +0.2 dB region, the input circuitry is slightly overdriven and, for this reason, the instrument may not meet its distortion specifications- even though the OVERLOAD light is off. When making distortion measurements that could be affected by the analyzer's internal distortion, be sure that the composite ac input-signal level is equal to or lower than the Range setting indicated by the "RANGE" readout. Do not rely on the OVERLOAD light as an indication that the distortion specifications are met.
- d. The 3585 has an internal limiting system which prevents the Reference Level from being set lower than 100 dB below Range or higher than 10 dB above Range. When the Reference Level is not coupled to the Range (REF LVL TRACK deactivated), this system will operate in reverse to prevent the Range from being set lower than 10 dB below the Reference Level or higher than 100 dB above the Reference Level. Attempts to exceed these limits (either manually or automatically) will cause the beeper to sound and an error message to appear on the CRT screen.

REFERENCE LEVEL TRACK FUNCTION





The Reference Level is the absolute amplitude represented by the top horizontal line of the CRT graticule. The 3585 Reference Level is settable from 100 dB below RANGE to 10 dB above RANGE with 0.1 dB resolution. By adjusting the Reference Level, any response within the 110 dB range can be moved to the top of the screen for measurement. *



The  function couples the Reference Level to RANGE. Thus, as the Range is changed (either automatically or manually), the Reference Level changes in corresponding 5 dB increments. The coupling does not operate in reverse; i.e., changing the Reference Level does not affect the Range.

When the REF LVL TRACK function is activated, the Reference Level changes in 5 dB steps along with the Range, no matter what the current Reference Level setting happens to be. However, the primary purpose of the coupling system is to initially set the Reference Level equal to the Range so that the vertical display range is compatible with the input-signal level.





The  and  functions are automatically activated when the  key is pressed at the beginning of a measurement. Range and Reference Level are both preset to +30 dBm; but with no input signal, the instrument automatically downranges to -25 dBm. With the REF LVL TRACK function activated, the Reference Level changes along with the Range; so it also drops to -25 dBm. When the signal source is initially connected to the Input, the instrument either remains on the -25 dBm Range or automatically upranges, depending on the input-signal amplitude. In either case, the Reference Level remains equal to the Range. With Range and Reference Level both set according to the input-signal amplitude, the vertical display range is automatically tailored to display the input-signal responses; and, in most cases, the largest response is at or near the top of the screen ready for measurement. In some cases, the noise level will be so low that the noise floor is entirely off screen. The Reference Level coupling does not compensate for this effect; but it does insure that the largest input-signal responses are on the CRT screen. Low-level signals that are below the display range can be moved onto the screen by lowering the Reference Level.

Once you have adjusted the frequency parameters to display the signals of interest, you may independently adjust the Reference Level to move individual responses to the top of the screen for measurement and/or vertical expansion. It is *not necessary* to deactivate the REF LVL TRACK function when adjusting the Reference Level. The REF LVL TRACK function will not affect the Range setting; nor will it interfere with the adjustment of the Reference Level. As long as the Range setting remains constant, the REF LVL TRACK function will not change the Reference Level.

After adjusting the Reference Level to measure one signal, it is often convenient to reset the Reference Level equal to the Range so that another signal can be quickly located and moved to the top of the screen for measurement. The Reference Level can be set equal to the Range at any time by simply turning the  function off and then back on.



For certain types of measurements, it is desirable to manually uprange or downrange without changing the Reference Level. For example, if you are measuring the low-level spurious components of a large signal, you may wish to leave the signal at the top of the screen and downrange one or two steps to improve the signal-to-noise ratio. To accomplish this, first deactivate  and then decrement the Range with  .



*The various Reference Level entry methods are outlined in Chapter 5 and are also described in the Basic Operating Procedure given in Chapter 2.

CHAPTER 5

MAJOR OPERATING PARAMETERS AND ENTRY FUNCTIONS

This chapter is intended to familiarize you with the 3585's major operating parameters, their entry functions and the basic sequences for changing parameter values using the Step keys and the Number/Units keyboard.

THE MAJOR PARAMETERS

The 3585 has twelve major operating parameters:











Amplitude	[Range Reference Level (REF) Vertical Scale (dB/DIV)	overload level top line of CRT graticule amplitude display range
Frequency	[Frequency Span (SPAN) Center Frequency (CENTER or CF) Start Frequency (START) Stop Frequency (STOP) Manual Frequency (MANUAL) Center-Frequency Step Size (STEP)	displayed frequency range center frequency of span lowest frequency of span highest frequency of span manual frequency tuning frequency increment for Center and Manual frequency steps
Bandwidth	[Resoluitiion Bandwidth (RBW) Video Bandwidth (VBW)	frequency selectivity and sensitivity noise averaging or "smoothing"
	Sweep Time (S.T.)	sweep rate

To efficiently operate the 3585, the operator must have a basic understanding of these operating parameters and the various entry methods that can be used to change their values.

OVERVIEW OF ENTRY METHODS

Overview Of Entry Methods

More than 60 percent of the keys on the 3585 front panel are dedicated to entering and controlling the major operating parameters. There are six different methods through which the parameters can be entered or adjusted:

Entry Method	Description	Parameters
Automatic/Coupled	<p>With  activated, Range is set automatically.</p> <p>With  activated, Reference Level is coupled to Range and, therefore, changes automatically along with Range.</p> <p>With  activated, RBW and VBW are set automatically as a function of Frequency Span; Sweep Time is automatically adjusted to maintain calibration.</p>	<p>Range</p> <p>Reference Level</p> <p>RBW, VBW, ST</p>
Step Entry	Change in steps using STEP keys:  OR 	All Parameters
Numeric Entry	Set value exactly using Number/Units keyboard: 	All Parameters except Range
Continuous Entry	Adjust using Continuous Entry control: 	Reference Level Center Frequency Manual Frequency
Marker Entry:	Single key (e.g., ) sets parameter equal to current Marker amplitude or Marker/Counter frequency.	Reference Level Center Frequency CF Step Size
Offset Entry	Single key (e.g., ) sets parameter equal to Offset frequency; i.e., the difference between the current Marker/Counter frequency and Marker/Counter frequency at which  pressed.	Frequency Span Start and Stop CF Step Size

The Automatic/Coupled functions are automatically activated when the  key is pressed at the beginning of a measurement. With these functions activated, the operator simply selects the desired input and impedance, connects the signal source and then adjusts the frequency parameters to display the signals of interest. During this process, the Range, Reference Level, RBW, VBW and Sweep Time parameters are set automatically. The settings that are selected automatically are not necessarily the best settings for your particular measurement; but they always provide a convenient starting point from which the parameters can be individually adjusted to obtain the required result.

Parameter Definitions

The remainder of this chapter is devoted to defining the major operating parameters and describing the general Step Entry and Numeric Entry sequences. The Automatic/Coupled functions are described in Chapters 4 and 7; the Continuous, Marker and Offset entry functions are described in Chapter 8.



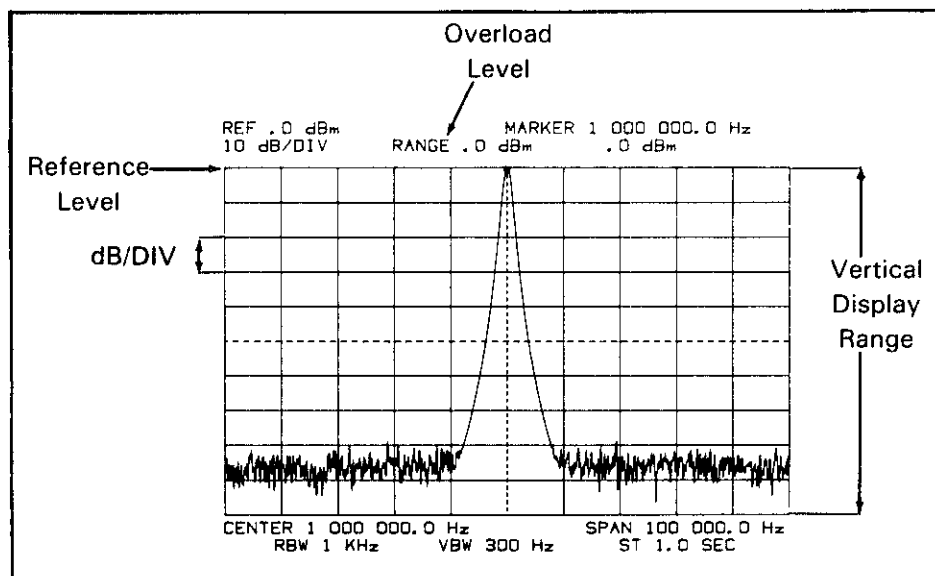

Amplitude Parameters



Amplitude Parameters

Range. The Range setting determines the maximum ac signal level that can be applied to the input without overdriving the input circuitry.

Settability: twelve settings; -25 dBm to +30 dBm, 5 dB steps
 Entry Methods:

AUTOMATIC	STEP	
AUTO RANGE 	ENTRY RANGE 	 

PARAMETER DEFINITIONS











Reference Level (REF). The Reference Level, represented by the top horizontal line of the CRT graticule, is the calibrated absolute amplitude to which the Marker amplitude readings are referenced and is also the amplitude value about which the vertical scale is expanded. The amplitude display range extends from approximately 0.23 divisions above the Reference Level to 10 divisions below the Reference Level.

For operating purposes, the Reference Level can be thought of as the absolute amplitude to which the top line of the CRT graticule is calibrated. It is important to note, however, that the CRT graticule is not internally generated; so there is absolutely no way for the 3585 to actually calibrate to the top graticule line. The correlation between the Reference Level amplitude and the trace amplitude at the top graticule line depends entirely on the CRT trace alignment which is *not specified*. To obtain the specified amplitude accuracy, you must make your measurements using the instrument's tunable Marker, rather than the CRT graticule. The Marker amplitude accuracy is relative to the Reference Level accuracy: When the Marker amplitude reading is equal to the Reference Level, the Marker accuracy is equal to the Reference Level accuracy. When the Marker amplitude is not equal to the Reference Level, the Marker accuracy is determined by the Reference Level Accuracy *and* Amplitude Linearity specifications.

The Reference Level is settable from 100 dB below RANGE to 10 dB above RANGE with 0.1 dB resolution. It can be entered and displayed in dBm, dBV or rms volts. The ability to adjust the Reference Level allows you to move the signals of interest to the top of the screen where they can be measured with Reference Level accuracy and/or expanded vertically by reducing the Vertical Scale (dB/DIV) setting. Low-level signals that are below the display range can be moved onto the screen by lowering the Reference Level. This is an important capability because it allows you to utilize the analyzer's full dynamic range which may easily exceed 100 dB when a narrow Resolution Bandwidth is used.

Settability: 100 dB below RANGE to 10 dB above RANGE; 0.1 dB resolution.

Entry Methods:

COUPLED TO RANGE	STEP	NUMERIC	CONTINUOUS	MARKER	
		STEP  	OR		 
		STEP  	OR		

Vertical Scale (dB/DIV). The vertical axis of the CRT graticule has ten major divisions and is calibrated in "dB" relative to the Reference Level. (The 3585 does not have a linear scale.) Each major division represents 10 dB, 5 dB, 2 dB or 1 dB, depending on the Vertical Scale (dB/DIV) setting. The 10 dB/DIV setting provides a display range of 100 dB, enabling both large and small signals (within the analyzer's dynamic range) to be observed simultaneously. The 5 dB, 2 dB and 1 dB settings expand the vertical scale downward from the Reference Level. This improves the amplitude resolution (the 2 dB and 1 dB settings also improve accuracy) but limits the display range to 50 dB, 20 dB or 10 dB, respectively. Signals that are above the Reference Level will overdrive the display; but this will not damage the instrument or degrade its performance. Signals that are below the display range can be moved onto the screen by lowering the Reference Level.

Settability: four settings; 10 dB, 5 dB, 2 dB or 1 dB per division
Entry Methods:

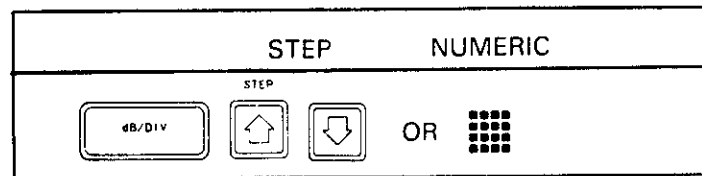

PARAMETER DEFINITIONS

Frequency Parameters

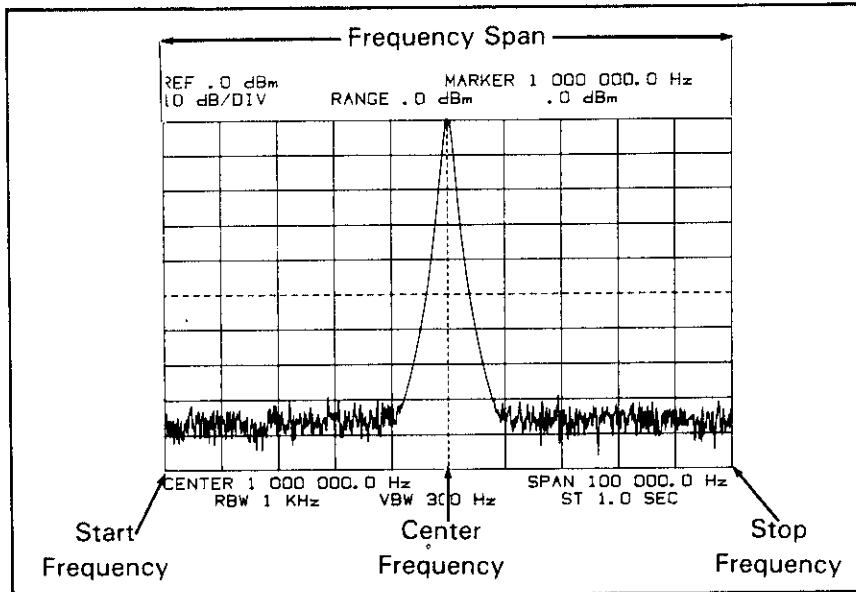

Frequency Parameters

Frequency Span (SPAN). Frequency Span (sometimes called “scan width”) is the portion of the analyzer’s frequency range that is displayed on the horizontal axis of the CRT and is the frequency range over which the instrument can be swept or manually tuned.

Settability: 0 Hz to 40.1 MHz; 0.1 Hz resolution

Entry Methods:

STEP		NUMERIC	OFFSET
FREQUENCY SPAN	STEP ↑ ↓	OR [Grid]	[SPAN]

Center Frequency (CENTER or CF). The Center Frequency, represented by the middle vertical line of the CRT graticule, is the frequency at which the Frequency Span is centered and the frequency about which the horizontal axis is expanded.

Settability: 0 Hz to 40.1 MHz; 0.1 Hz resolution

Entry Methods:

STEP	NUMERIC	CONTINUOUS	MARKER
CENTER FREQUENCY	STEP ↑ ↓	OR [Grid]	CONT ○
			[CF]

PARAMETER DEFINITIONS

Start Frequency (START). The Start Frequency, represented by the first vertical line on the left-hand side of the CRT graticule, is the lower frequency limit of the Frequency Span and the frequency at which the sweep begins.

Stop Frequency (STOP). The Stop Frequency, represented by the right-most vertical line of the CRT graticule, is the upper frequency limit on the CRT trace. (The 3585 sweeps 0.1% of the Frequency Span *past* the Stop Frequency. The positive peak video amplitude in that 0.1% region is displayed at the Stop Frequency point on the CRT.)

Settability (Start and Stop): 0 Hz to 40.1 MHz; 0.1 Hz resolution
Entry Methods:

STEP		NUMERIC	OFFSET
START FREQ	OR	STOP FREQ	DFS SPAN
STEP			
↑	OR	↓	
		NUMERIC	

Manual Frequency (MANUAL). The 3585 has a "Manual" mode in which the electronic frequency sweep is disabled and the 3585 functions as a tunable receiver or "tunable voltmeter" which can be set to any frequency within the selected Frequency Span. The frequency to which the analyzer is tuned in the Manual mode is referred to as the "Manual" frequency. The Manual mode provides a convenient way to make real-time amplitude measurements at the specific frequencies of interest without waiting for a frequency sweep.

Settability: any frequency within the Frequency Span; 0.1 Hz resolution.
Entry Methods:

STEP		NUMERIC	CONTINUOUS
ENTRY	OR	NUMERIC	MAN SWEEP
MANUAL	STEP		
↑	OR	↓	

Center Frequency Step Size (STEP). The Center Frequency and Manual frequency can be incremented or decremented using the STEP keys. The Center-Frequency Step Size parameter sets the Center-Frequency *and* Manual-Frequency step size.

Settability: 0 Hz to 40.1 MHz; 0.1 Hz resolution
Entry Methods:

STEP		NUMERIC	MARKER/OFFSET
CF STEP SIZE	OR	NUMERIC	DFS SPAN MKR DFS STEP
STEP			
↑	OR	↓	

PARAMETER DEFINITIONS

Bandwidth And Sweep Time Parameters

ENTRY METHODS (RBW, VBW and ST)

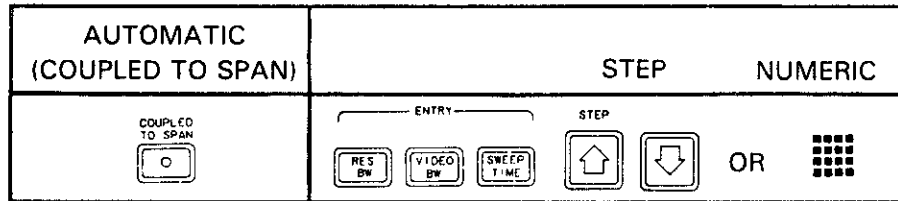

Resolution Bandwidth (RBW). The Resolution Bandwidth setting determines the 3 dB bandwidth of the final IF filter which, in turn, establishes the frequency selectivity of the instrument. Narrowing the Resolution Bandwidth improves the analyzer's ability to separate or "resolve" signals that are closely spaced in frequency; and it also lowers the noise level which improves the sensitivity and noise-free dynamic range. Narrow bandwidths increase the analyzer's response time and, therefore, require slow sweep rates.

Wide Resolution Bandwidths are generally used with wide frequency spans for spectrum surveillance and fast, broadband signal analysis. Narrow bandwidths and narrow spans are used for detailed examination of individual responses, distortion products, modulation sidebands, noise sidebands, close-in spurious responses, etc. The 3585's nine Resolution Bandwidth settings make it easy to separate and measure signals regardless of their frequency spacing.

Settability: nine settings; 3 Hz to 30 kHz; 1, 3, 10 sequence

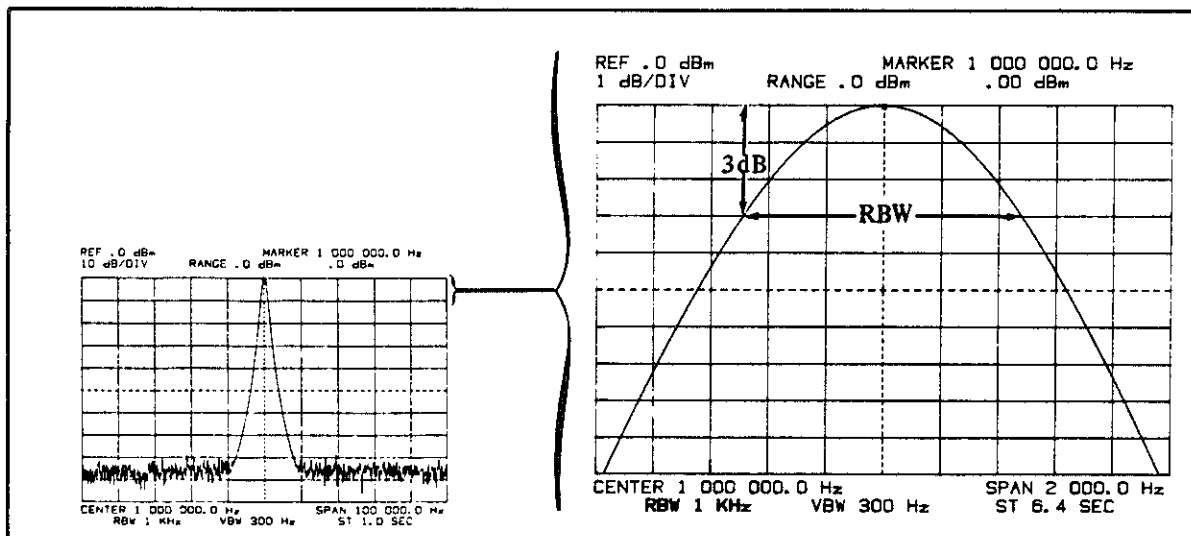

Resolution Bandwidth

Video Bandwidth (VBW). The Video Bandwidth setting determines the 3 dB bandwidth of the instrument's post-detection video filter which averages or "smooths out" the noise appearing on the CRT. Narrowing the Video Bandwidth reduces the peak noise variations on the CRT display, making it easier to discern low-level responses that are near the noise floor. The video filtering is the most effective when the Video Bandwidth is 10% to 1% of the Resolution Bandwidth. Narrowing the Video Bandwidth increases the analyzer's response time, making it necessary to sweep at a slower rate to maintain amplitude calibration.

Settability: ten settings; 1 Hz to 30 kHz; 1, 3, 10 sequence

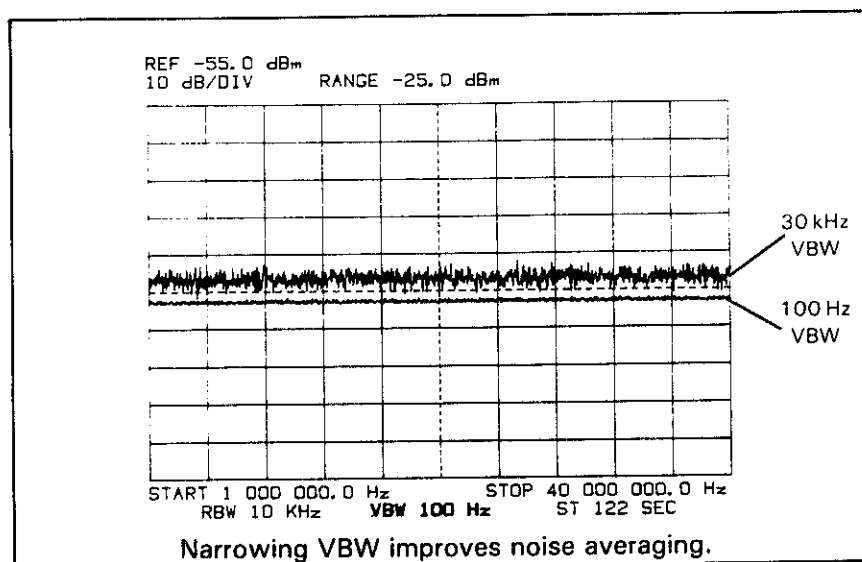

Video Bandwidth

Sweep Time (ST). The Sweep Time setting determines the *sweep rate* in Hertz per second:

$$\text{Sweep Rate (Hz/sec)} = \frac{\text{Frequency Span (Hz)}}{\text{Sweep Time (seconds)}}$$

Due to internal processing requirements, a frequency sweep may be interrupted (i.e., stopped and restarted) more than 40 times before it finally reaches the Stop Frequency. Because of these interruptions, the total time required to sweep across the Span may be noticeably longer than the Sweep Time setting. The Sweep Time setting determines the time that is actually spent sweeping; it does not include time delays caused by sweep interruptions.

Settability: 0.2 sec to 99,999.8 sec with 0.2-sec resolution;
100,000 sec to 999,999 sec with 1-sec resolution

(Minimum sweep-rate limit is 0.1 Hz/sec for 30 kHz and 10 kHz RBW; 0.005 Hz/sec for all other RBW settings. Sweep Time can be stepped up to 59,652 hours; i.e., 6.81 years.)

ENTRY KEYS

ENTRY KEYS

Each of the twelve major parameters has a dark brown ENTRY key which, when pressed, activates or "prefaces" that parameter, enabling it to be changed using the STEP keys or the Numeric Entry keys. Only one parameter can be prefaced at a time and the parameter that is prefaced (if any) is displayed brighter than the other parameters on the CRT.

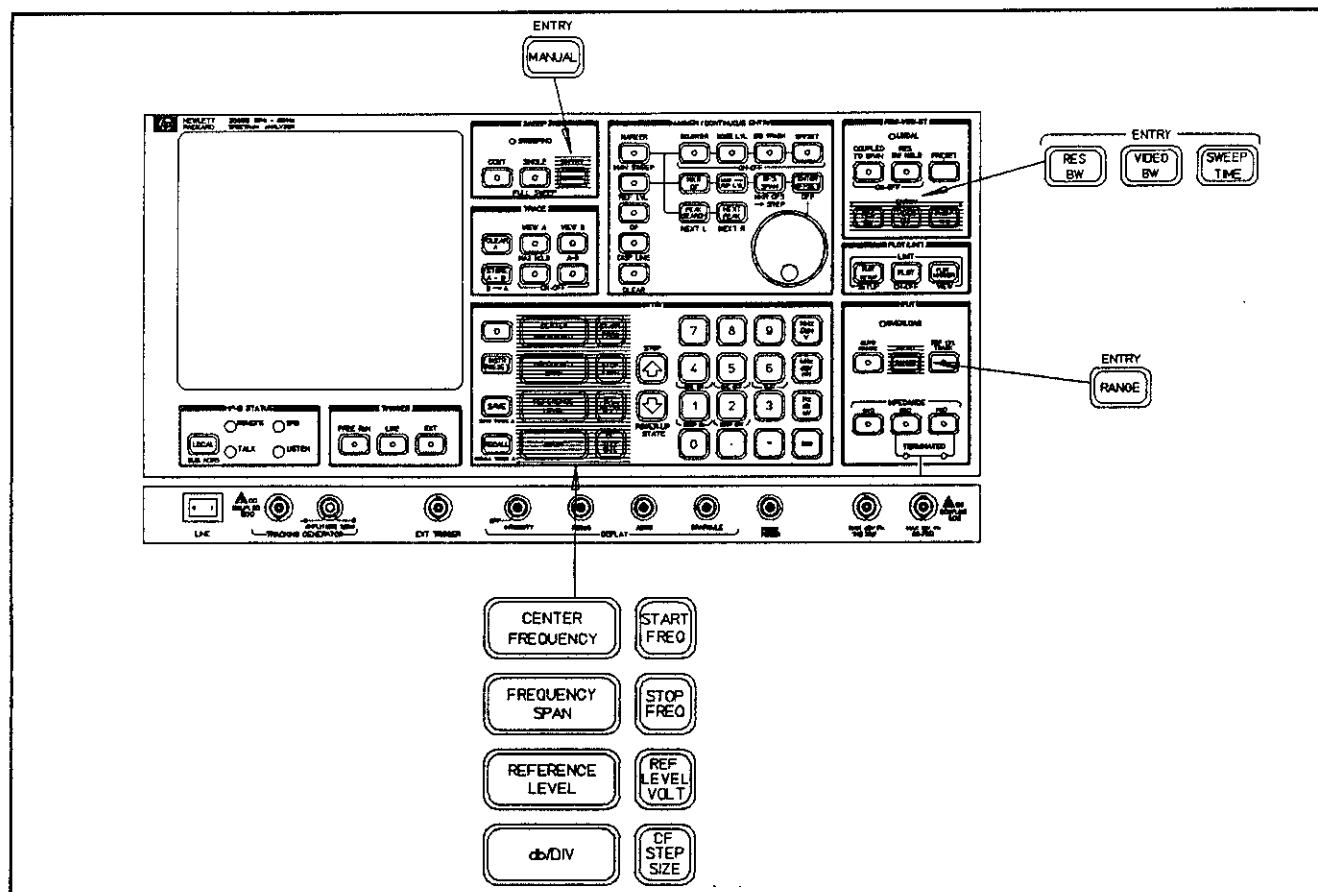

ENTRY Key Locations

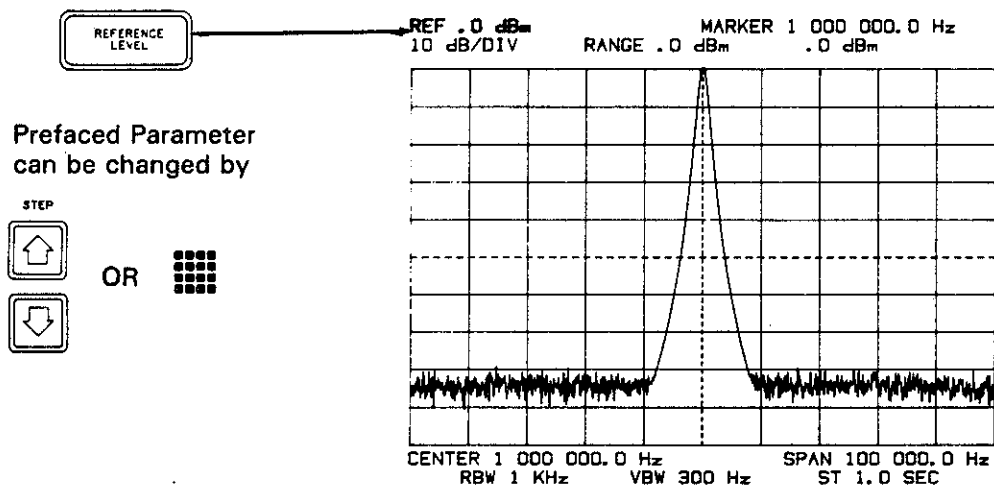

NOTES

1. The Range setting can be changed using the STEP keys; but it cannot be entered numerically. The "RANGE", REF and amplitude readouts can be converted from "dBm" to "dBV" (or vice-versa) by entering

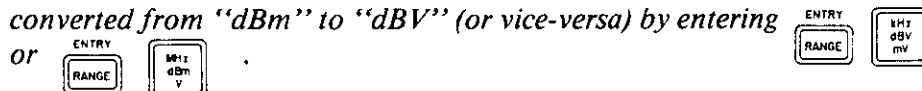

2. The Reference Level parameter has two Entry keys:

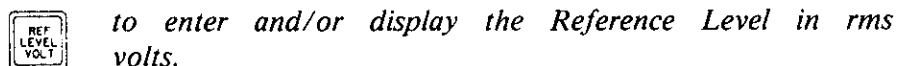
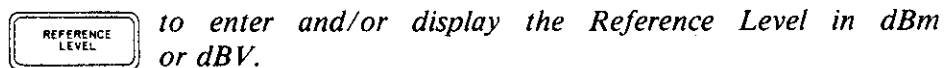

The "RANGE" and amplitude readouts are displayed in the same units as the Reference Level.





Unprefacing .

The parameter that is currently prefaced can be unprefaced by:

a. Prefacing a different parameter.

b. Pressing an *appropriate* Suffix key. (e.g.,  will unpreface Sweep Time but will not unpreface a frequency, amplitude or bandwidth parameter.)

c. Pressing a Marker/Offset Entry key:    

d. Pressing  OR  OR  OR  OR 

e. Activating  will unpreface "RANGE".

PARAMETER READOUTS

PARAMETER READOUTS

The parameter readouts display the current values of the operating parameters and also, the digits that are entered during a Numeric Entry sequence. Any of the twelve major parameters can be displayed on the CRT; but only eight can be displayed simultaneously:

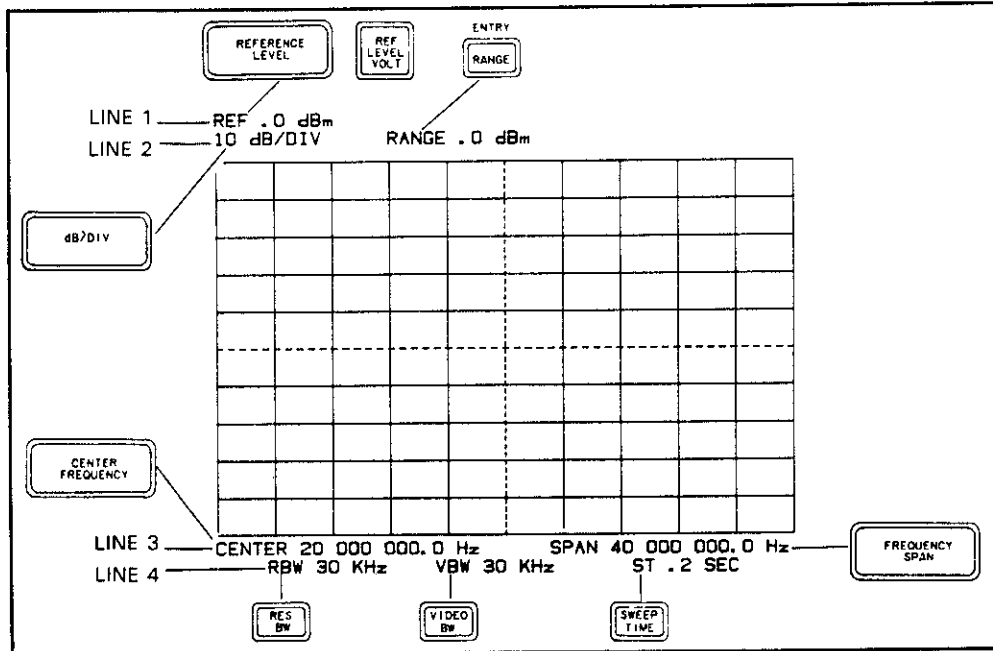

Parameter Readout Locations

The parameters appearing in Lines 1, 2 and 4 are always displayed. Line 3 displays the pertinent frequency parameters defined by the operator's entry:

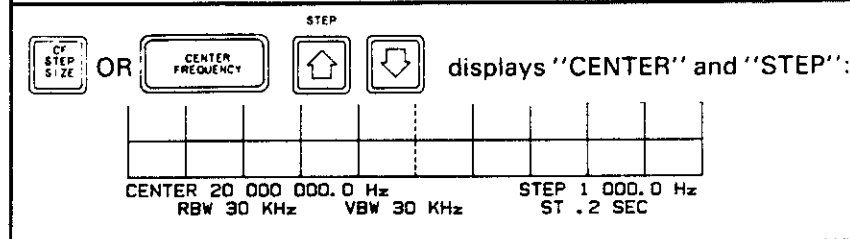
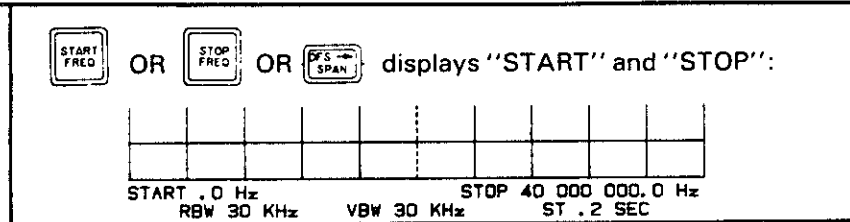
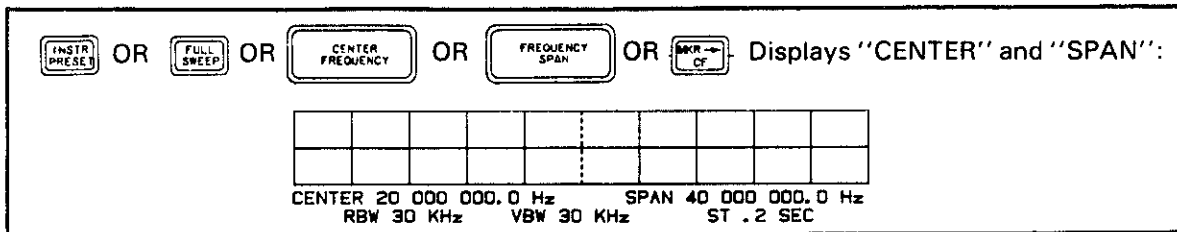

PARAMETER READOUTS

When the Manual frequency is *prefaced*, the "MANUAL" frequency is displayed in place of "CENTER" or "START":*

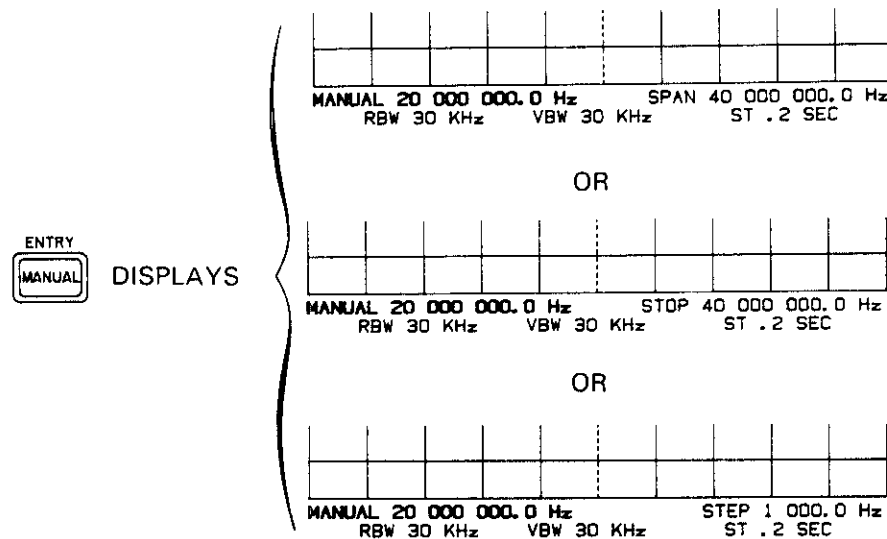

When the "MANUAL" entry is terminated, the display reverts to "CENTER" and "SPAN":

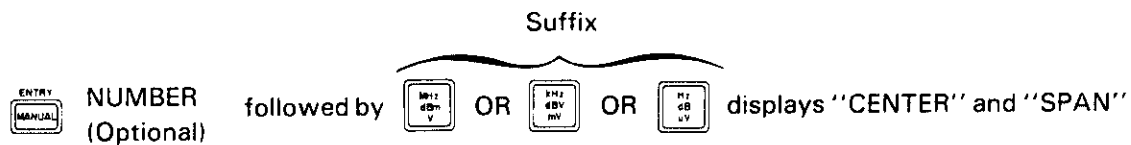



*When the Marker is at the Manual frequency point on the CRT trace and the COUNTER, OFFSET and DISPL LINE functions are deactivated, the Manual frequency is also displayed in the upper right-hand corner of the screen (whether or not it is prefaced).

Overview of Traces and Trace Functions

The 3585's graphic traces are digitally-stored, point-by-point plots consisting of 1,001 equally spaced points. The points are difficult to see because they are interconnected by straight lines generated by the instrument's Display Processor. There are two trace memories, "A" and "B", in which two complete 1,001-point traces can be stored. The traces can be viewed separately or simultaneously using the

 and  keys:

a. The Current ("A" or "A-B") Trace:



As the analyzer's frequency is swept, digitized video samples are stored in Trace Memory "A". With the  function activated, the contents of Trace Memory "A" are written onto the CRT screen at a rapid, flicker-free rate to produce the Current Trace. The Current Trace is the *only* trace that is updated by the frequency sweep or in the Manual mode. When the  function is activated, the "B" Trace is subtracted from the current "A" Trace to produce the "A-B" Trace which is used for trace comparisons.

b. The "B" Trace:

If the active trace is needed for future reference, it can be copied to trace B (with Store A→B) or any of ten trace registers (with (blue) Save Trace A). Trace B can be displayed at any time by pressing the View B key.



Displays Current ("A" or "A-B") Trace that is stored in Trace Memory "A".

(Automatically activated by  or by deactivating  ; press to deactivate, press again to activate.)





Erases Trace Memory "A" and clears Current Trace from CRT screen. Resets and rearms continuous sweep; terminates single sweep.



Non-destructively transfers Current Trace to Trace Memory "B". Automatically activates .



Displays trace that is stored in Trace Memory "B".

(Automatically activated by  or deactivating  ; press to deactivate, press again to activate.)

NUMERIC ENTRIES

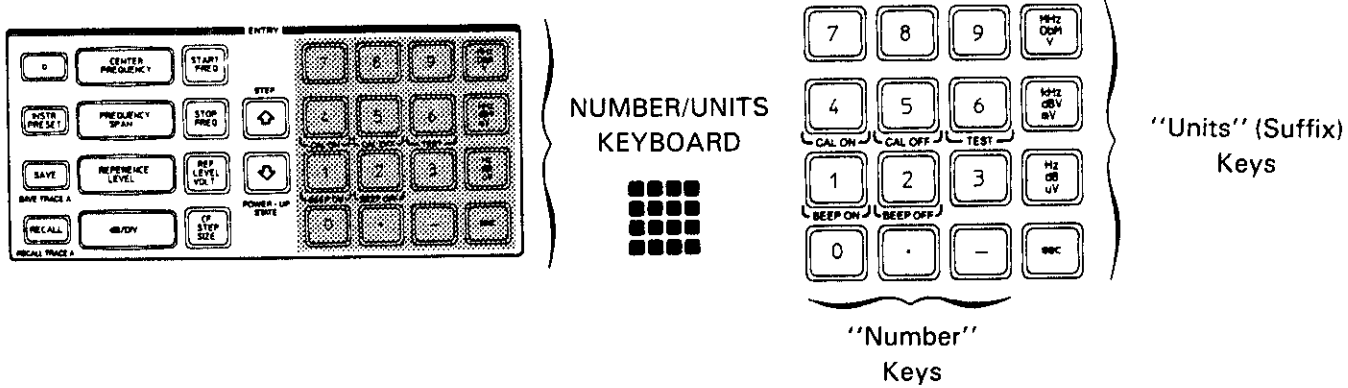

Numeric entries permit the operator to set the parameters to the exact values that are needed to make a specific measurement. While all of the major operating parameters (except Range) can be entered numerically, Numeric entries are used primarily to set the frequency parameters such as Center Frequency and Frequency Span or Start and Stop.

Numeric Entry Sequence.

Numeric entries require three steps:

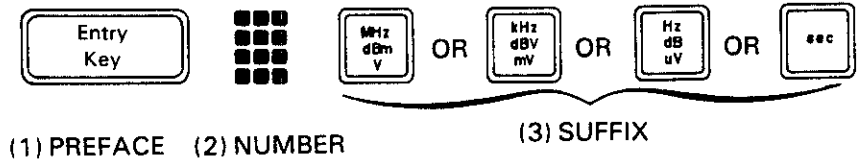

Example:



NUMERIC ENTRIES

Entry Sequence

Decimal Point And Leading Zeros

The NUMBER portion of the entry may contain a decimal point . If it does not, the decimal is understood at the end of the number. Leading zeros (if entered) are ignored.

Corrections

The only way to correct the NUMBER portion of a Numeric Entry is to repace the parameter by again pressing the ENTRY key. Pressing the ENTRY key at any time during the entry sequence erases the digits that have been entered and returns the current value to the screen.

Multiple Changes

Numeric entries (unlike Step entries) *terminate* the entry sequence. You must, therefore, repace the parameter each time a Numeric Entry is required.

Negative Entries



Reference Level (dBm or dBV) is the only parameter (except Range) that has negative values. The "minus" sign  is ignored for all other parameters.

The Number/Units keyboard does not have a "plus" (+) sign. Therefore, if a minus sign is not entered, positive polarity is assumed. The minus sign is usually entered at the beginning of the number; but it can be entered between numeric digits or at the end of the number. (No matter where the minus sign is entered, it is automatically placed at the beginning of the number.)

The polarity of a Reference Level entry can be reversed (i.e., positive to negative OR negative to positive) at any time during the entry sequence by pressing the  key.

Free Entry Format

The 3585 uses a "free-entry" format which allows you to make Numeric entries in the units that are most convenient:

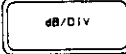



<p>Frequency and Bandwidth entries can be made in "Hz", "kHz" or "MHz"</p> <p>Example:</p> <p>A Frequency of 10 MHz can be entered as 10,000,000.0 Hz, 10,000 kHz or 10 MHz.</p> <p>A Bandwidth of 30 kHz can be entered as 30,000 Hz, 30 kHz or 0.03(000) MHz.</p>
<p> entries can be made in "V", "mV" or μV</p> <p>Example:</p> <p>A Reference Level of one millivolt can be entered as 0.001 V, 1.00 mV or 999 μV (3-digits maximum; 999 μV is rounded to 1 mV.)</p>
<p> entries can be made in "dBm" (50 Ω or 75 Ω) or "dBV" (1 V rms = 0 dBV)</p>
<p> entries can be made in "dB", "dBm" or "dBV". (Vertical Scale is defined in "dB" per division; the suffix is arbitrary.)</p>

NUMERIC ENTRIES

Display Units

Display Units

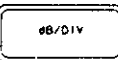
During the Numeric Entry sequence, the digits that are entered are displayed on the CRT. However, when the suffix key is pressed, the entry is displayed in standard, internally-defined units which may differ from the units in which the entry was made:

	settings are displayed in "dBm" or "dBV" (as entered) with 0.1 dB resolution. Entries containing two fractional digits (0.OX dB) are rounded off to 0.1 dB. If an entry contains more than two fractional digits, only the first two fractional digits are accepted; the remaining fractional digits are ignored.
	settings are displayed in "V", "mV", "µV" or "nV" (Table 1).*
	settings are displayed in "dB" with 1 dB resolution.
All frequency parameters are displayed in "Hz" with 0.1 Hz resolution. "Hz" entries containing more than one fractional digit are automatically <i>truncated</i> to 0.1 Hz resolution (maximum frequency resolution is 0.1 Hz).	
 and 	settings 300 Hz and narrower are displayed in "Hz"; settings 1 kHz and wider are displayed in "kHz".
Sweep Time is displayed in seconds (SEC), minutes (MIN) or hours (HRS) as outlined in Table 2. (Sweep Time is entered in seconds; the <i>display</i> conversion to minutes or hours does not affect the entry; e.g., a Sweep Time of 2000.0 sec [3.33 minutes] is displayed as 3.3 minutes but the actual Sweep Time is 2,000.0 sec.)	

*Reference Level voltage settability is limited to 0.1 dB (approximately 1%). When a Reference Level voltage is entered, the 3585 converts that entry to "dBV", sets the Reference level accordingly and then reconverts the "dBV" setting to volts and displays the result. Because of this settability limitation and the rounding-off process that is used in the conversion routine, the Reference level voltage that is finally displayed may differ slightly from the voltage that you entered.

Table 1. Reference Level Volts Display.

REF LEVEL	DISPLAY
0.125 μ V to 1.00 μ V*	125 nV to 1,000 nV
1.00 μ V to 1.00 mV*	1.00 μ V to 1,000 μ V
1.00 mV to 1.00 V*	1.00 mV to 1,000 mV
1.00 V to 27.3 V	1.00 V to 27.3 V

*These transition points are not well defined; e.g., 1.00 V will sometimes be displayed as 1,000 mV and other times as 1.00 V, depending on how it is processed internally.

Table 2. Sweep Time Display.

Sweep Time	Disp. Units	Disp. Resolution
0.2 sec to 99.8 sec	SEC	0.2 SEC
100.0 sec to 999.8 sec	SEC	1 SEC
1,000.0 sec to 5,999.8 sec	MIN	0.1 MIN
6,000.0 sec to 359,999 sec	HR	0.1 HR
360,000 sec to 214,748,160sec*	HR	1 HR

*Maximum Numeric Entry is 999,999 seconds but Sweep Time can be incremented to maximum value shown using STEP keys.

NUMERIC ENTRY CONSTRAINTS

Numeric Entry Constraints

General

Entries that exceed the upper or lower limit of a parameter are not accepted; i.e., the parameter does not change, the beeper sounds and an error message (typically "OUT OF RANGE") appears on the CRT screen. If the "out of range" entry is the result of pressing the wrong suffix key (e.g., "MHz" instead of "kHz"), the entry can be completed by simply pressing the correct suffix key. If the NUMBER portion of the entry is unacceptable, you must either reface the parameter and enter a valid number or, if the number is too small, add digits to the entry. (Digits may be added without reprefacing.)

There is also a limit to the number of digits that can be entered for a given parameter (leading zeros, decimal point and minus sign are not counted as digits). Attempts to enter more than the maximum number of digits cause the beeper to sound and the error message, "TOO MANY DIGITS" to appear on the CRT screen. This occurs before the suffix key is pressed and, therefore, does not affect or terminate the entry. The digit entry that produces the error message is not accepted; but preceding digits are retained, and if they constitute a valid entry, they are accepted when the suffix key is pressed.

Limits are as follows:

PARAMETER	LOWER LIMIT	UPPER LIMIT	MAX. DIGITS
Reference Level (dBm/dBV)*	100 dB below Range	10 dB above Range	4
Reference Level Volt*	100 dB below Range	10 dB above Range	3
Vertical Scale	1 dB	10 dB	2
Frequency Span**	0 Hz	40.1 MHz	9
Center Frequency**	0 Hz	40.1 MHz	9
Start Frequency***	0 Hz	40.1 MHz	9
Stop Frequency***	0 Hz	40.1 MHz	9
Manual Frequency	Start Frequency	Stop Frequency	9
CF Step Size	0 Hz	40.1 MHz	9
Res. Bandwidth	3 Hz	30 kHz	5
Video Bandwidth	1 Hz	30 kHz	5
Sweep Time	0.2 sec	see following text	6

* Reference Level entries that exceed the lower limit produce the error message, "REF < 100 dB BELOW RNG"; entries that exceed the upper limit produce the error message; "REF > 10 dB OVER RANGE".

** Whenever the Center Frequency and Frequency Span settings are such that the Start Frequency is below 0 Hz or the Stop Frequency is above 40.1 MHz, the "out of range" portion of the CRT Trace is blanked and the message, "SWEEP SPAN LIMITED" appears on the screen.

*** If the Start Frequency entry is higher than the current Stop Frequency, the Stop Frequency is automatically set equal to the Start Frequency. Conversely, if the Stop frequency entry is lower than the current Start Frequency, the Start Frequency is set equal to the Stop Frequency.

Vertical Scale, RBW and VBW

The Vertical Scale (dB/DIV), RBW and VBW parameters have a limited number of discrete settings. To numerically set the value of these parameters, you must enter a specific setting that is available:

dB/DIV	RBW	VBW
10 dB	30 kHz	30 kHz
5 dB	10 kHz	10 kHz
2 dB	3 kHz	3 kHz
1 dB	1 kHz	1 kHz
	300 Hz	300 Hz
	100 Hz	100 Hz
	30 Hz	30 Hz
	10 Hz	10 Hz
	3 Hz	3 Hz
		1 Hz

Vertical Scale entries other than those listed or entries containing a decimal point will not be accepted; i.e., the setting will not change, the beeper will sound and the message, "/DIV = 1;2;5;10 ONLY" will appear. Attempts to enter more than two digits will cause the beeper to sound and the "TOO MANY DIGITS" message to appear. The first two digits will be accepted if they constitute a valid entry.

The RBW and VBW settings listed can be entered with up to five digits using the free-entry format. Attempts to enter more than five digits will cause the beeper to sound and the "TOO MANY DIGITS" message to appear. Entries other than those listed will not be accepted; i.e., the setting will not change, the beeper will sound and the error message, "1;3;10 STEPS ONLY" will appear.

Sweep Time

The maximum Sweep Time that can be entered (Numeric or Step) is determined by the Resolution Bandwidth and Frequency Span settings:

Resolution Bandwidth	Minimum Sweep Rate	Maximum Sweep Time(sec)
30 kHz or 10 kHz	0.1 Hz/sec	10 × Freq. Span (Hz)
3 kHz thru 3 Hz	0.005 Hz/sec	200 × Freq. Span (Hz)

Entries exceeding the maximum Sweep Time limit will not be accepted; i.e., the Sweep Time will not change, the beeper will sound and the error message, "SWEEP RATE TOO SMALL" will appear on the CRT.

Sweep Time is settable from 0.1 seconds to 99,999.8 seconds with 0.2-second resolution and from 100,000 seconds to 999,999 seconds with 1-second resolution. Attempts to enter more than six digits will cause the beeper to sound and the "TOO MANY DIGITS" message to appear on the CRT. The first six digits will be accepted if they constitute a valid entry.

Fractional entries can be made only in 0.2-second steps; i.e., 0.2, 0.4, 0.6 or 0.8 seconds. Fractional entries that are not in 0.2-second steps will be accepted; but when the suffix key is pressed, the fractional digit will automatically be incremented by 0.1 second and the error message, "S.T. IN .2 SEC STEPS" will appear on the CRT.

CHAPTER 6

CRT DISPLAY AND TRACE FUNCTIONS

This chapter describes the 3585's CRT display, the DISPLAY adjustments, the graphic traces and TRACE functions and the alphanumeric readouts.

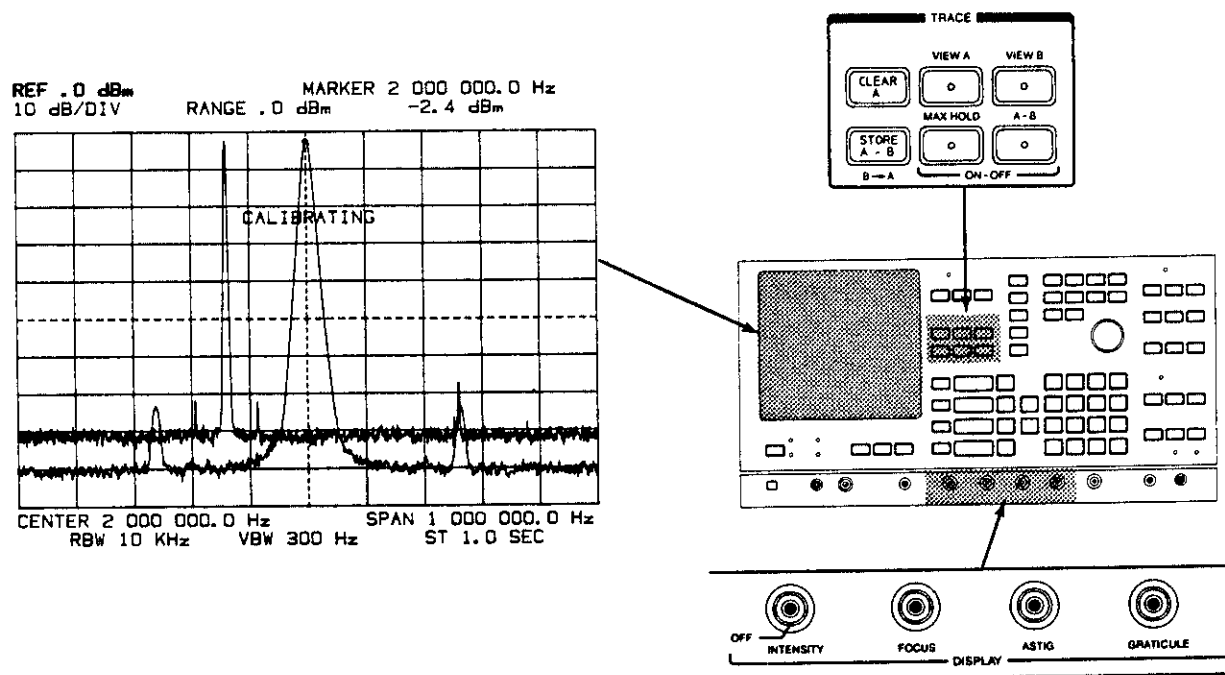

INTRODUCTION AND OVERVIEWS

The 3585's screen displays two graphic traces of amplitude versus frequency information as well as marker and display-line information, measurement data, alphanumeric readouts of operating parameters, and a variety of messages indicating status, failures, and errors. All of the information appearing on the screen can be simultaneously displayed on an auxiliary monitor connected to the rear-panel display outputs. Most of this information may be plotted on an HP-GL plotter connected to the rear-panel HP-IB connector. See Chapter 1 for more information concerning the display and plotting.

Remote Capabilities

The graphic traces and alphanumeric readouts appearing on the CRT screen can be remotely transmitted to an external device via the HP-IB. As an added feature, the CRT can be used to display externally-generated graphics and alphanumeric messages that are input from the HP-IB. Details concerning these remote display capabilities are included in Part Two of Section III.

OVERVIEW

Display Controls

The DISPLAY controls, aligned horizontally along the bottom recess of the front panel, affect both the graphic and alphanumeric display presentations:



Controls the brightness of the graphic traces and alphanumeric readouts. The display is blanked when the control is in the OFF (full CCW) position. The intensity is internally limited; so you may select any comfortable setting without danger of burning the CRT face. The INTENSITY control does not affect the graticule illumination.

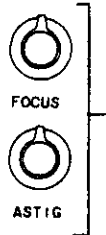

Set the FOCUS control to midrange. Adjust the ASTIG (Astigmatism) control for the sharpest trace possible and then adjust the FOCUS control for the sharpest trace possible. Iterate between the ASTIG and FOCUS controls until optimum adjustment is obtained.





Adjusts the background illumination provided by a flood gun within the CRT. Background illumination improves the contrast making it easier to see the CRT graticule. (This control can also be used to help establish the desired contrast when taking CRT photographs.)

Overview of Traces and Trace Functions

The 3585's graphic traces are digitally-stored, point-by-point plots consisting of 1,001 equally spaced points. The points are difficult to see because they are interconnected by straight lines generated by the instrument's Display Processor. There are two trace memories, "A" and "B", in which two complete 1,001-point traces can be stored. The traces can be viewed separately or simultaneously using the

 and  keys:

a. The Current ("A" or "A-B") Trace:



As the analyzer's frequency is swept, digitized video samples are stored in Trace Memory "A". With the  function activated, the contents of Trace Memory "A" are written onto the CRT screen at a rapid, flicker-free rate to produce the Current Trace. The Current Trace is the *only* trace that is updated by the frequency sweep or in the Manual mode. When the  function is activated, the "B" Trace is subtracted from the current "A" Trace to produce the "A-B" Trace which is used for trace comparisons.

b. The "B" Trace:

If the active trace is needed for future reference, it can be copied to trace B (with Store A→B) or any of ten trace registers (with (blue) Save Trace A). Trace B can be displayed at any time by pressing the View B key.



Displays Current ("A" or "A-B") Trace that is stored in Trace Memory "A".

(Automatically activated by  or by deactivating  ; press to deactivate, press again to activate.)





Erases Trace Memory "A" and clears Current Trace from CRT screen. Resets and rearms continuous sweep; terminates single sweep.



Non-destructively transfers Current Trace to Trace Memory "B". Automatically activates .



Displays trace that is stored in Trace Memory "B".

(Automatically activated by  or deactivating  ; press to deactivate, press again to activate.)

OVERVIEW

Subtracts trace B from trace A and stores it in the trace A memory register (which continues to be displayed). This represents the amplitude of trace A relative to trace B. The A-B trace is referenced to the middle graticule line (0 dB).



The A-B trace reference (0 dB) may be changed from the center line through the use of the Display Line. Turn on the Display Line and move it the position chosen for the new reference. Then press (blue) A-B. This command does not change any display information active when it is executed; only subsequently displayed graphics and text are affected. This value is saved and recalled with the instrument state. The A-B reference is reset to the middle graticule line by Instrument Preset.

(Press to activate; press again to deactivate.)



Updates the amplitude at each point in the A trace memory only if the current video sample is higher in amplitude (more positive) than the sample that is already stored. As a result, the current trace retains the maximum positive video amplitude that occurs over successive frequency sweeps or at the manual measurement point.

(Press to activate; press again to deactivate.)

Marker Overview

Markers are simply intensified dots that appear at discrete points on the display traces. There are three markers that can be displayed:

1. Tunable Marker:

The tunable marker can be moved along the trace by activating the marker and turning the knob, to measure the frequency and amplitude at any point on the trace. The marker's frequency and amplitude values are displayed in the upper right-hand corner of the display. The marker can also be used in conjunction with the marker functions to perform offset measurements, counter and noise level measurements, and change parameter values. In the manual mode, the marker automatically tracks the manual frequency to provide a direct reading of the manual frequency and signal amplitude.

2. Stationary (Offset) Marker:

When the Offset function is active, a stationary marker dot appears at the point on the displayed trace representing the Offset Marker reference; the point from which the tunable marker's amplitude and frequency are measured. This point is selected by moving the tunable marker to the point chosen for the offset reference and pressing the Enter Offset key.

3. Sweep Marker:

When the instrument is sweeping and the sweep time is one second or larger, a sweep marker appears on the current trace to indicate the position of the frequency sweep. The sweep marker jumps from point-to-point along the trace, but the actual frequency sweep is continuous rather than incremental.

THE GRAPHIC PRESENTATION

Display Graticule

The graphic traces are displayed on a standard CRT graticule, having ten horizontal divisions and ten vertical divisions. The dashed graticule lines are the center axes. The horizontal axis represents absolute frequency; the vertical axis represents the absolute amplitude of the "A" or "B" Trace or, on the "A-B" Trace, the amplitude of Trace "A" relative to Trace "B".

The graticule aspect
ratio (Y/X) = 1:1.56

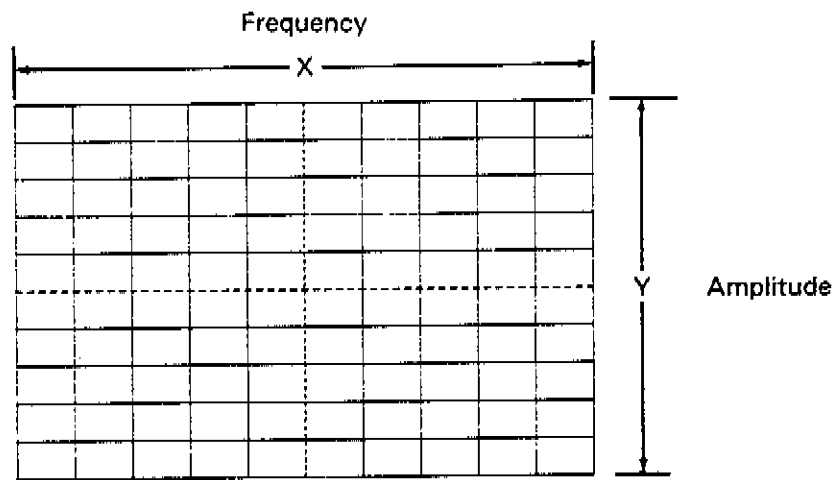

CRT Graticule

Horizontal Axis

As the analyzer's frequency is swept, the Current Trace is plotted from left-to-right across the CRT screen. The first vertical line on the left-hand side of the display graticule represents the Start Frequency, the middle vertical line represents the Center frequency and the right-most vertical line represents the Stop Frequency.

The frequency range between the Start Frequency and the Stop Frequency is the Frequency Span. The Start Frequency Stop Frequency, Center Frequency and Frequency span parameters are all settable within the range of 0 Hz to 40.1 MHz with 0.1 Hz resolution. Whenever the Center Frequency and Frequency Span settings are such that the Start Frequency is lower than 0 Hz or the Stop Frequency is higher than 40.1 MHz, the sweep span is automatically limited and the out-of-range portion of the Current Trace is blanked. This causes the "SWEEP SPAN LIMITED" message to appear on the CRT screen.*

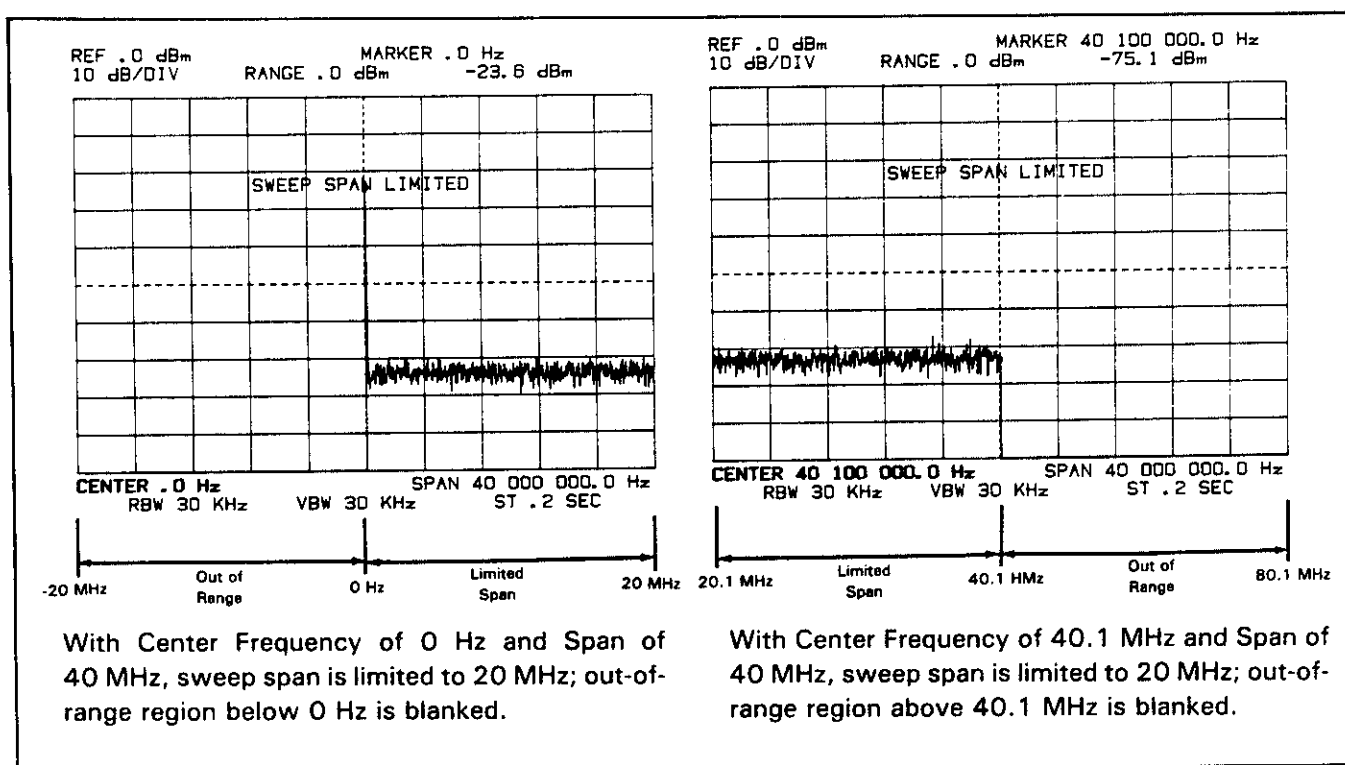

Limited Sweep Span

*The "SWEEP SPAN LIMITED" message remains on screen for about 5 to 10 seconds and then disappears.

A limited sweep span condition will *erase* the "out of range" portion of a Current Trace that is retained on screen after a single sweep has terminated.

GRAPHICS

Vertical

Vertical Axis

The vertical axis is calibrated in logarithmic units of "dB" relative to the Reference Level which is represented by the top graticule line. The vertical display range extends from approximately 0.23 divisions above the top graticule line to 10 divisions below the top graticule line. Amplitude accuracy is *not specified* in the region above the Reference Level. However, the accuracy in that region is *typically* ± 0.5 dB with respect to the Reference Level accuracy.

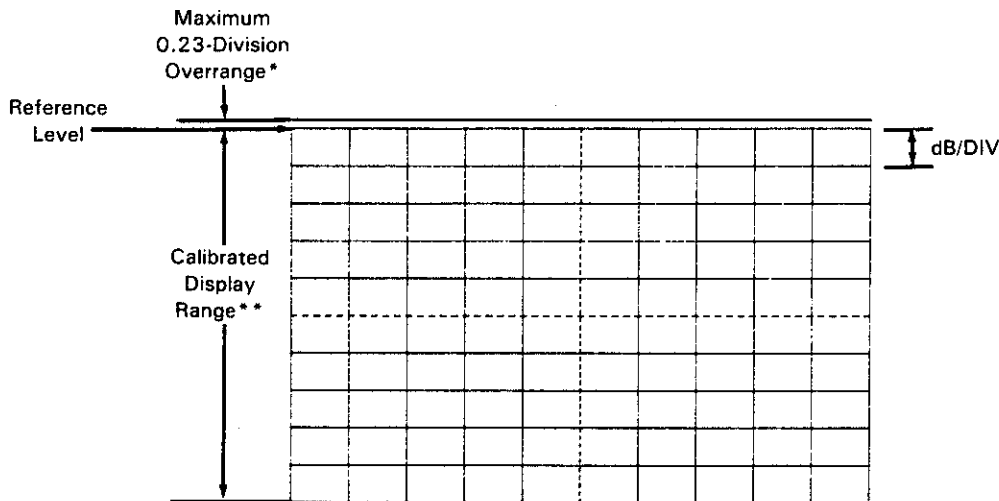

*0.23 divisions = 2.3 dB, 1.15 dB, 0.46 dB or 0.23 dB; depending on the Vertical Scale (dB/DIV) setting. Amplitude accuracy is unspecified in this overrange region.

**The CRT graticule is not actually calibrated. "Calibrated" display range refers to the display range in which the *Marker* amplitude accuracy is specified.

Vertical Display Range

Vertical Scale

The 3585 has four Vertical Scale (dB/DIV) settings: 10 dB, 5 dB, 2 dB and 1 dB per division. The 10 dB/DIV setting provides a vertical display range of 100 dB; however, the Marker amplitude accuracy is specified only in the top 90 dB portion of that range. The 5 dB, 2 dB and 1 dB per-division settings expand the vertical scale downward from the Reference Level. This improves the amplitude resolution, but limits the display range to 50 dB, 20 dB or 10 dB, respectively. The 1 dB and 2 dB per-division settings provide a 0.1 dB improvement in the Reference Level (and Marker) accuracy.

Signals that are higher than 0.23 divisions above the Reference Level will overdrive the display, but will not damage the instrument or affect the amplitude accuracy within the calibrated display range.

Introduction To Digital Storage

Spectrum analyzers require some form of display storage to retain the slowly scanned graphic trace information on the CRT. In traditional spectrum analyzers, this is accomplished by the use of a "storage CRT" in which the trace is retained by the phosphor or a storage mesh located behind the CRT face. Nevertheless, modern spectrum analyzers such as the 3585 use a digital storage technique in which discrete samples of the analyzer's detected video output are converted to binary numbers and stored in a digital memory. The digital memory containing the stored trace is then scanned at a fixed rate and its contents (after being reconverted to analog) are written onto the CRT. The major advantages of digital storage are:

- a. Digital storage permits the use of a standard oscilloscope CRT. Standard CRT's are rugged and relatively inexpensive to replace.
- b. Display adjustments are not required when the frequency and sweep parameters are changed. The digitally stored trace is displayed at a fixed rate independent of Sweep Time.
- c. The INTENSITY and FOCUS controls have the same effect as those on a regular oscilloscope. Once they are set they do not need to be readjusted. Also, the trace intensity can be set to any level with out danger of burning the CRT face. Digital storage provides a bright, crisp, flicker-free presentation; there is no blooming or display ambiguity.
- d. A trace that is stored in a digital memory can be retained and displayed indefinitely...as long as the instrument is turned on.
- e. In a microprocessor-based system such as the 3585 , traces that are digitally stored can also be digitally processed to perform trace arithmetic and provide special trace functions that would not otherwise be available.

The Digital Storage Concept

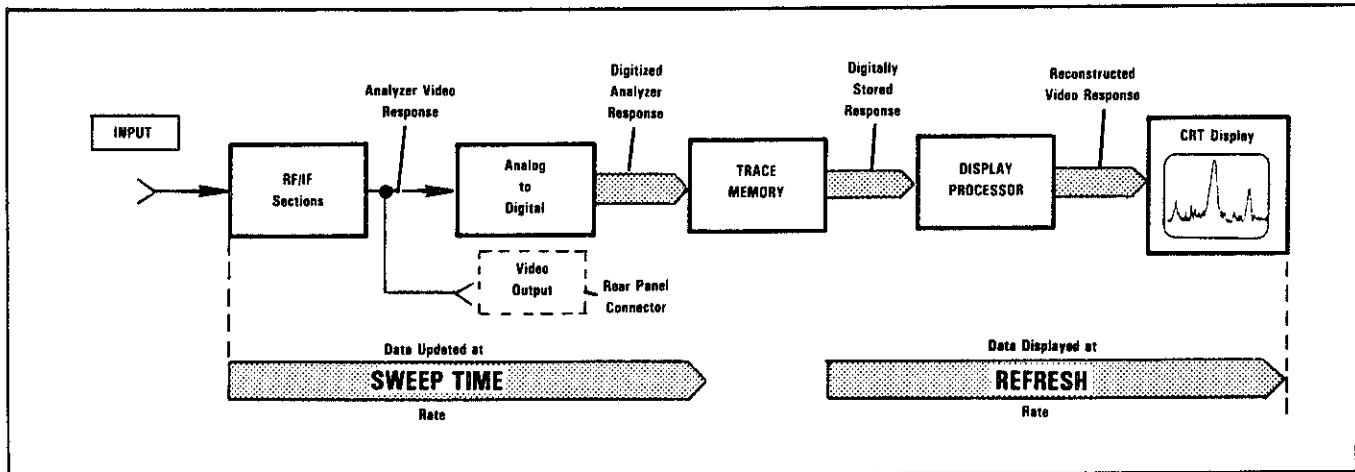

The above figure is a simplified block diagram showing the main signal path from the Input connector to the CRT display. The RF and IF sections of the analyzer comprise a swept superhetrodyne receiver whose output is a dc voltage that is logarithmically proportional to the input-signal amplitude. This dc voltage or "video response" is applied to the Analog-to-Digital (A/D) Converter where it is peak detected, sampled and transferred to the Trace Memory at a rate proportional to the Sweep Time.

The Trace Memory, in which the digitized video samples are stored, has 1,001 storage locations or "addresses". After a frequency sweep has been made, each address contains a 10-bit binary number representing the video amplitude at a specific frequency point on the CRT trace. Since each address represents a specific frequency point and the binary number in a given address represents the video amplitude at that point, the Trace Memory, in effect, contains a point-by-point plot of the amplitude-vs.-frequency display.

The entire CRT display (including alphanumerics) is typically updated or "refreshed" every 17 milliseconds or approximately 60 times each second. This provides a flicker-free presentation that is totally independent of Sweep Time.

At some point during each CRT refresh period, the Trace Memory is cycled through its 1,001 addresses in synchronism with a horizontal sweep generated by the Display Processor. During this sequence, the binary numbers that are read out of the Trace Memory are converted to dc voltages. If these dc voltages were applied directly to the vertical deflection system, the graphic trace would appear as a series of dots on the CRT screen. To avoid this situation, the Display Processor, which contains a variable-slope line generator, draws lines between the dots to provide a fully reconstructed display. As a result, the trace that is written onto the CRT screen consists of 1,001 discrete points, connected by 1,000 straight-line vectors.

Frequency Resolution

One inherent drawback associated with a point-by-point spectral display is that its frequency resolution is limited according to the number of points on the trace and the frequency spacing between them. This effect is particularly noticeable when using the 3585's tunable Marker: As the Marker frequency is varied with  , the Marker dot jumps from point-to-point along the trace and the "MARKER" readout indicates the frequency and amplitude at each point. Since the Marker cannot be set between two points, its frequency resolution is limited by the resolution of the point-by-point display.

With 1,001 equally-spaced points, the frequency spacing between points is equal to the Frequency Span divided by 1,000 or 0.1% of the Frequency Span. Two signals whose frequency spacing is less than 0.1% of the Frequency Span cannot be separated on the CRT trace even when a narrow Resolution Bandwidth is used:

In Figure A, for example, the Frequency Span is 40 MHz and the frequency spacing between points is $40 \text{ MHz}/1,000 = 40 \text{ kHz}$. Although there is only one response appearing on the trace, there are actually two input signals. One is -6.00 dBm at 10.00 MHz and the other is 0.00 dBm at 10.035 MHz. The Resolution Bandwidth is set to 1 kHz which is narrow enough to fully resolve both signals. Because of the limited display resolution, however, the two signals appear as one response. Also, because of the positive peak detection described in later paragraphs, the amplitude of the response is equal to the larger of the two signals (0 dBm, 10.035 MHz); but is displayed at the 10.00 MHz point.

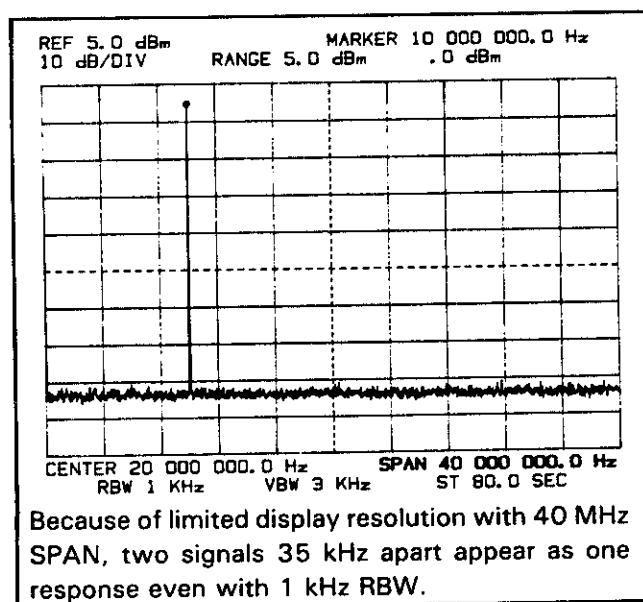

Figure A.

GRAPHICS

Amplitude Resolution

Narrowing the Frequency Span decreases the frequency spacing between points on the CRT trace and, therefore, improves the frequency resolution. As shown in Figure B, a 1 MHz Span provides the resolution needed to completely separate the two signals.

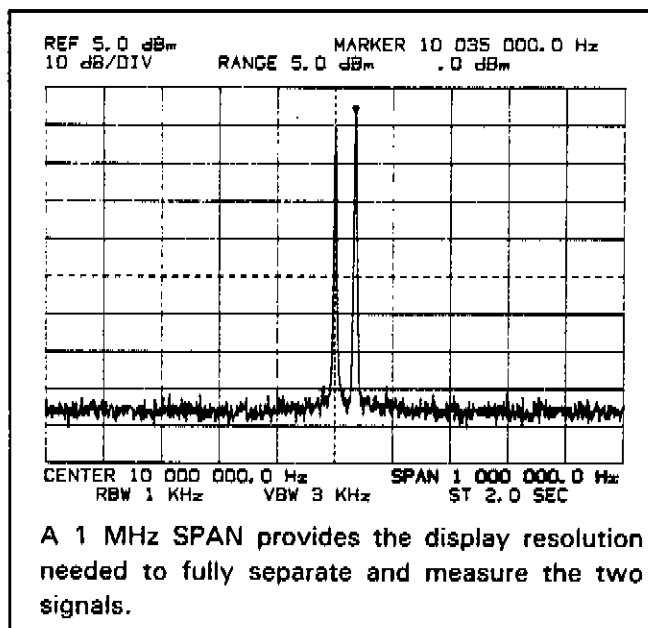

Figure B.

Amplitude Resolution

The video amplitude at each point on the CRT trace is represented by a 10-bit binary number. This means that the total vertical display range is represented by 2^{10} or 1,024 discrete amplitude values, referred to as "display units". The display range within the top and bottom graticule lines contains 1,001 display units; while the overrange region above the top graticule line contains an additional 23 display units.

With 1,001 display units in ten vertical divisions, each major division represents 100 display units. The amplitude resolution is, therefore, equal to the dB/DIV Vertical Scale setting divided by 100. For instance, if the Vertical Scale is 10 dB/DIV, the amplitude resolution is $10 \text{ dB}/100 = 0.1 \text{ dB}$. Similarly, if the Vertical Scale is 1 dB/DIV, the amplitude resolution is $1 \text{ dB}/100 = 0.01 \text{ dB}$.

Peak Detection

The 3585 must be able to display and accurately measure the peak amplitude of any response that can be resolved on the CRT screen. This presents a problem because the CRT trace is a point-by-point plot in which the points appear at fixed frequencies that do not necessarily correspond to the frequencies of the responses whose peaks must be displayed. For example, if the Frequency Span is 40 MHz and the Start Frequency is 0 Hz, there will be points at 0 Hz, 40 kHz, 80 kHz, 120 kHz, 160 kHz, 200 kHz, etc. However, the peaks of the responses that the operator wishes to measure could be between any of these points:

For instance, a 70 kHz input signal containing odd and even harmonics would produce responses at 70 kHz, 140 kHz, 210 kHz, 280 kHz, 350 kHz, etc. But with a 40 MHz Span, only one of these responses (280 kHz) would peak at a discrete point on the CRT trace. The peaks of the remaining responses would be clipped by the straight lines that are drawn between points. Moreover, a very narrow response occurring between two points would be missed entirely and would not appear on the trace.

To eliminate this potential problem, the 3585 uses a technique called "positive peak detection". With positive peak detection, the digitized video samples that are stored in the Trace Memory represent the positive peak video amplitude that occurs during each segment of the frequency sweep. This means that *each point on the CRT trace represents the positive peak video amplitude in the region between it and the following point:*

For example, if the points are 40 kHz apart, the 40 kHz point represents the positive peak video amplitude in the region between 40 kHz and 80 kHz; the 80 kHz point represents the positive peak video amplitude in the region between 80 kHz and 120 kHz, etc.*

With this technique, any resolved response that even raises its head above the noise is retained and displayed at a discrete point on the CRT trace, regardless of the frequency spacing between points. If there are points at 40 kHz and 80 kHz, a response that peaks at 70 kHz will not be missed but it will appear at the 40 kHz point. If the instrument's tunable Marker is then set to the peak of that response, the amplitude readout will accurately indicate the peak amplitude, although the frequency readout will indicate 40 kHz.

The negative frequency offset caused by peak detection is of little consequence since the frequency of a response can be precisely measured using the 3585 COUNTER function. Also, the frequency resolution and accuracy of the CRT trace and Marker can be improved by narrowing the Frequency Span. For instance, if the Span were narrowed from 40 MHz to 20 MHz, the points would be 20 kHz apart and the peak of a 70 kHz response would appear at the 60 kHz point rather than the 40 kHz point.

*Only 1,000 of the 1,001 Trace Memory addresses are filled by the time the frequency sweep reaches the Stop Frequency. To obtain a sample for Trace Memory address 1,001 (i.e., the Stop Frequency point on the trace), the 3585 sweeps 0.1% of the Frequency Span past the Stop Frequency. Thus, the amplitude of the Stop Frequency point on the CRT trace represents the positive peak video amplitude in the 0.1% region above the Stop Frequency.

GRAPHICS

Peak Detection/Sweep Dynamics

Peak Detection And Sweep Dynamics

Peak detection introduces a negative frequency offset on the CRT trace, but this effect is often counteracted by the positive frequency skew caused by sweep dynamics:

When the 3585 is sweeping rapidly, the response of the IF filter delays the arrival of the responses that are applied to the A/D Converter. Positive responses that arrive too late to be displayed at one point are retained by the peak detection circuit and displayed at the following point. Consequently, they appear at a higher frequency on the CRT trace.

When the analyzer is sweeping at the maximum-calibrated rate, the positive frequency skew is approximately 33% of the Resolution Bandwidth setting. The frequency skew is inversely proportional to Sweep Time; e.g., a factor of four (two step) increase in Sweep Time will reduce the frequency skew by a factor of four.

In some cases, the positive frequency skew caused by sweep dynamics is just enough to override the negative frequency offset caused by peak detection:

In the following figure, the instrument is sweeping at the maximum calibrated rate and the Marker is set to the peak of a response whose true frequency is 20.035 MHz. This response would ordinarily peak at the 20.00 MHz point; but because of the positive frequency skew, the peak is displayed at the 20.04 MHz point as indicated by the "MARKER" frequency readout. Since 20.04 MHz is closer to 20.035 MHz than 20.00 MHz, the frequency skew in this particular case is improving the frequency accuracy:

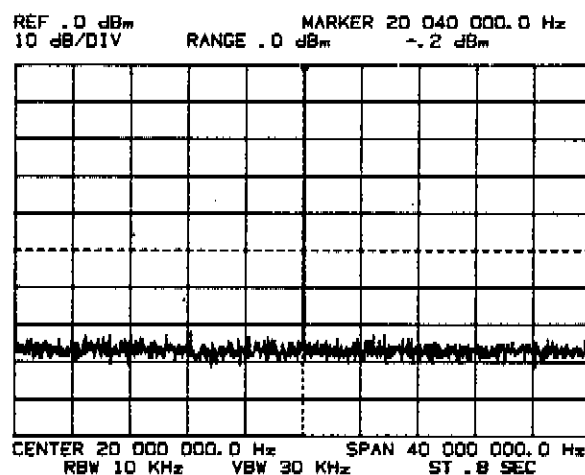

With optimum Sweep Time, 20.035 MHz response is skewed to the right and displayed at the 20.04 MHz point on the CRT trace.

In the next figure, the Sweep Time has been increased by a factor of four to minimize the frequency skew. As a result, the peak of the 20.035 MHz response is displayed at the 20.00 MHz point. From an accuracy standpoint, this effect could also work in reverse. For instance, a 19.065 MHz response could be skewed over to the 20.00 MHz point during a fast sweep and then move back to the 19.06 MHz point when the Sweep Time is increased.

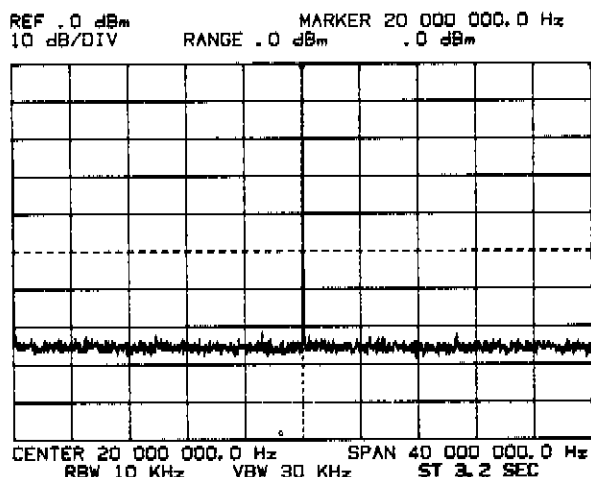

Sweep Time increased two steps to minimize frequency skew. Because of peak detection, 20.035 MHz response is now displayed at the 20.00 MHz point.

(Increasing the Sweep Time also minimized the amplitude compression, causing the signal amplitude to increase by 0.2 dB.)

Sweep dynamics also cause amplitude compression:

When the analyzer is sweeping rapidly, the IF and video filters do not have enough time to fully respond to the rapid changes in amplitude that occur as the sweep passes through a signal. This compresses the signal's response, causing it to appear at a slightly lower level on the CRT screen. When the instrument is sweeping at the maximum-calibrated rate, the worst-case amplitude compression is about 0.2 dB. Amplitude compression can be minimized by increasing the Sweep Time; or it can be completely eliminated by using the Manual mode.

NOTE

The effects of peak detection are negligible in the Manual mode. During Manual mode operation, the Trace Memory address that represents the Manual measurement point is updated every 200 microseconds; but the Manual measurement point is only updated every 17 milliseconds (i.e., the CRT refresh rate). While the peak detector is not disabled in the Manual mode, it is reset after each 200-microsecond sample and does not have the opportunity to accumulate the maximum positive amplitude that occurs over a significant time interval.

Effects Of Peak Detection And Time Interval

Each point on the CRT trace represents the positive peak video amplitude in a region that is equal to 0.1% of the Frequency Span. Similarly, each point also represents the positive peak video amplitude for a *time interval* that is equal to 0.1% of the Sweep Time. When the analyzer is sweeping over a response whose amplitude is stable, the amplitude of the video signal changes according to the slope of the response which, in turn, is strictly a function of frequency. Thus, the trace that is plotted is independent of the time interval. Because of the positive peak detection, however, any positive excursions that occur as a function of *time*, such as transients and noise spikes, are *retained* on the CRT trace. Increasing the Sweep Time increases the time interval for each point on the trace and, therefore, increases the probability that a transient will appear on the trace. For instance, a trace that is plotted over a ten-hour period is more susceptible to transients than a trace that is plotted over a 0.2-second period.

Peak Detection And Noise

The effects of peak detection and time interval are particularly noticeable when the analyzer is sweeping over random noise:

- a. Because of the positive peak detection, only the positive noise peaks are displayed. In the absence of negative peaks, the average value of a random noise signal on the CRT screen *appears* to be significantly higher than it actually is. To illustrate this, the following figure shows a side-by-side comparison of the same noise level plotted with and without peak detection. As indicated by the "DISPLAY LINE" amplitude, the average value of the peak-detected noise appears to be about 4.6 dB higher than that of the non peak-detected noise:

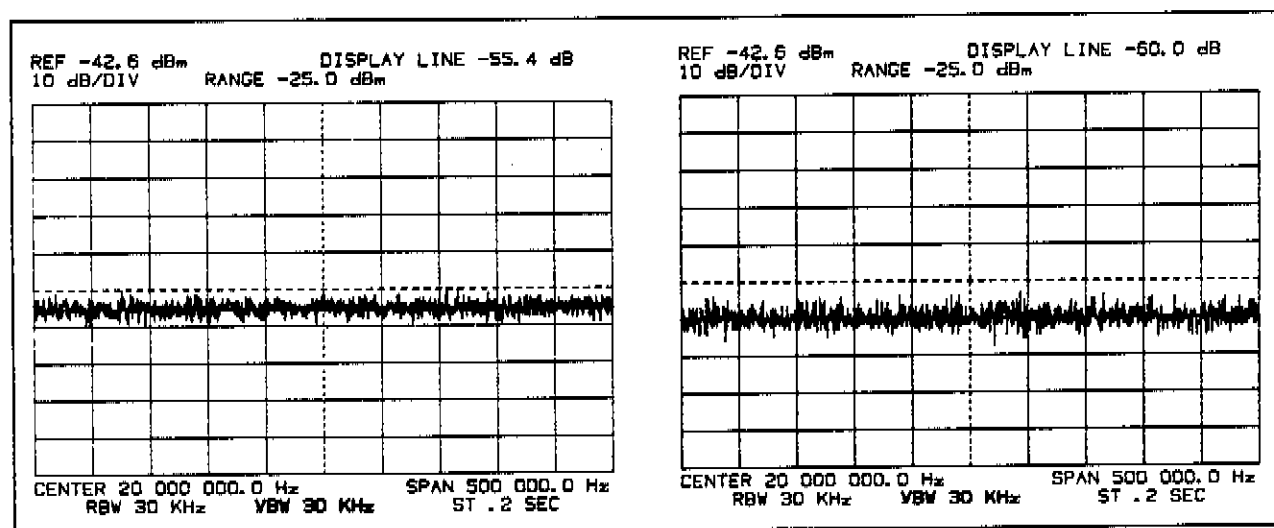

Noise With Peak Detection

Noise Without Peak Detection

- b. Narrowing the Video Bandwidth averages the noise *before* it reaches the peak detector and, therefore, minimizes the effects of peak detection. In the following figure, the VBW has been narrowed to 1% of the RBW to obtain good noise averaging. The true average values of the peak-detected and non peak-detected noise signals are approximately the same:

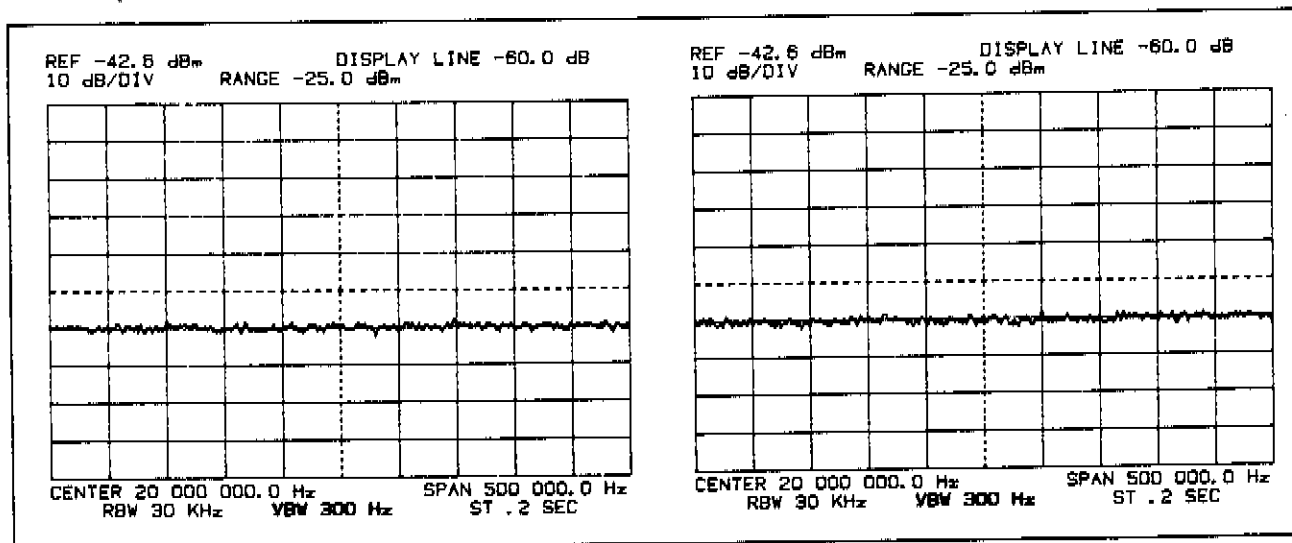

Average Peak-Detected Noise

Average Non Peak-Detected Noise

- c. Increasing the Sweep Time increases the time interval which, in turn, gives the random noise a greater opportunity to reach a maximum positive value at each point on the CRT trace. For this reason, the level of a noise signal that is plotted with insufficient video filtering will *appear* to increase as a function of Sweep Time:

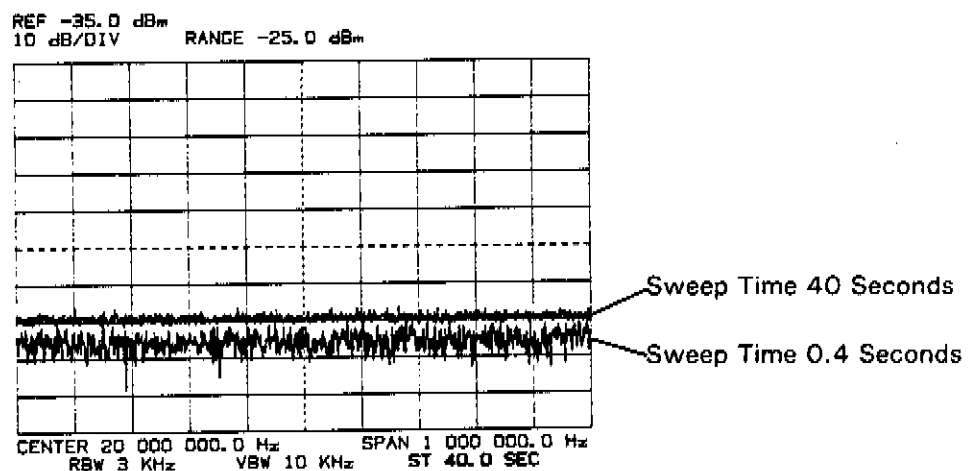

GRAPHICS

Peak Detection/Time Interval

- d. The effects of Sweep Time can be minimized by narrowing the Video Bandwidth to 1% of the Resolution Bandwidth (or narrower). In the following figure, the *both* traces were plotted with a 40-second Sweep Time. The upper trace, showing the effects of peak detection, was plotted with a VBW or 10 kHz. The lower trace, showing an apparent 10 dB decrease in the noise level, was plotted with a VBW of 30 Hz:

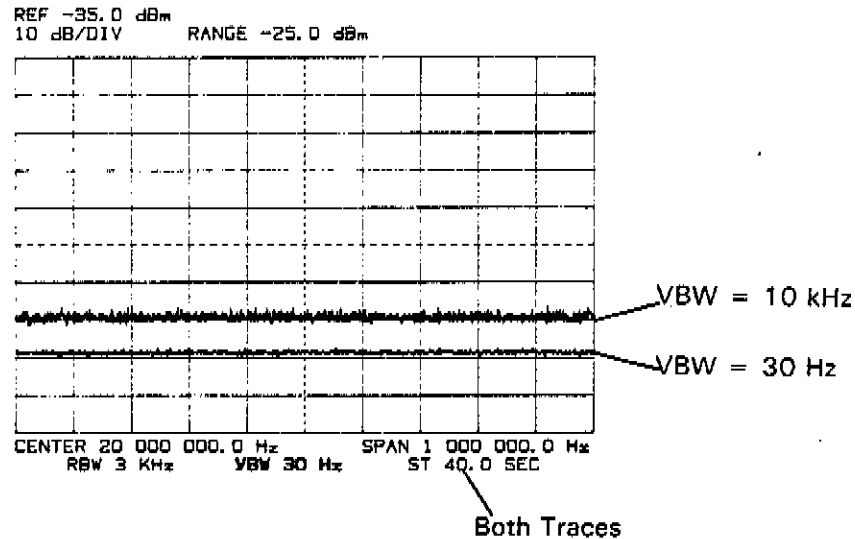

Measuring Noise

Random noise can best be measured using the 3585 NOISE LVL function described in Chapter 8, or by using the Manual mode to minimize the effects of peak detection. To measure the rms average noise level in the Manual mode, set the VBW to 1% of the RBW for good video averaging and add +2.5 dB to the "MANUAL" amplitude readout. (This +2.5 dB includes a 1 dB correction for the instrument's average responding detector and a 1.5 dB correction for the log converter.)

Where necessary, the approximate average noise level can be measured from the CRT trace using the following procedure:

- Set the Video Bandwidth to 1% of the Resolution Bandwidth or narrower. (Narrow the Frequency Span to minimize Sweep Time.)
- Ignoring the UNCAL indicator, decrement the Sweep Time until the displayed noise level no longer decreases. (The spectrum shape of the noise should be gradually changing, not abrupt, allowing the analyzer to follow it well.)
- Set the Marker to the point of interest on the noise floor.
- Add +2.5 dB to the "MARKER" amplitude reading to determine the rms value of the average noise.

TRACE FUNCTIONS

Storing and Viewing Traces

Display Memory. Traces may be stored in display memory (registers A and B, commonly referred to as "trace A" and "trace B") or in trace memory registers (0–9). The display memory used to hold trace A is the most often used because this is where all active measurement information is displayed. If Continuous Sweep is active, display register A is updated at the rate of 1/(Sweep Time).



Data (trace information) in trace A may be copied into trace B by pressing Store A→B. Data may be copied from trace B to trace A with the (blue) B→A function.



Data in display register B may be displayed by pressing the View B key. While trace B is displayed, the light in the center of the key is illuminated. Trace B may be removed from the display by pressing the View B key again. While trace B is displayed, trace A may be removed from the display by pressing View A. Turning off a trace display does not erase the data in the display register.

NOTES

1. Trace information stored in display memory register A is constantly overwritten if Continuous Sweep is active. If you copy a trace from B to A with the (blue) B→A function you should probably select Single Sweep first or the data will be overwritten by the next measurement sweep.

2. Whenever the center frequency and frequency span settings cause the start frequency to be less than zero or the stop frequency to be greater than 40.1 MHz, the sweep span is limited and the "out of range" portion of the trace is blanked. The blanking is accomplished by erasing portions of register A. If trace A is being preserved by not sweeping (Single Sweep is active) and the frequency parameters are changed such that part of the trace becomes "out of range," that portion of data in register A will be erased.

3. To make a measurement on display register data, the frequency span and center, reference level, and scale must be the same as when the data was taken.

Trace Memory. Trace Memory registers 0–9 are used to store measurement data. These may be used to store data converted from trace A display data for later access. The conversion process uses the currently-active values of reference level and scale to create values in dBV (or dB, if A–B is the data being saved) which is stored in one of the ten registers.



To save or recall a trace, press the (blue) Save Trace A key or the (blue) Recall Trace B key (respectively), and one numeric digit key (0-9) in the entry section.

NOTES

1. Data is stored in trace memory with no indication of what frequency span is active. Therefore, the start and stop frequencies or center and span frequencies must be tracked independently. The span should be returned to the value active when the trace was stored before recalling a stored trace.

2. Do not confuse trace memory registers 0–9 with instrument state registers 0–9.

Trace Identification

The two traces are displayed at the same intensity; so it is sometimes difficult to determine which one is "A" and which one is "B". When in doubt, the operator can, of course, turn off the "B" Trace, identify the "A" Trace and then turn the "B" Trace back on. There are, however, some other distinguishing features that should be noted:

- When the analyzer is sweeping and the Sweep Time is one second or longer, a sweep marker dot appears on the Current ("A" or "A-B") Trace to indicate the position of the frequency sweep. When the Sweep Time is less than one second, the sweep marker is not displayed; but the Current Trace will normally exhibit amplitude variations as it is updated by the frequency sweep. The "B" Trace, *totally unaffected* by the frequency sweep, will not change.
- When both traces are being displayed, the instrument's tunable Marker will appear on the Current Trace rather than the "B" Trace.
- When the analyzer is sweeping or in the Manual mode, the Current Trace will respond to a change in operating parameters as it is updated by the frequency sweep or at the Manual measurement point. The "B" Trace is *not affected* by the operating parameters.

The Maximum Hold Function



When the MAX HOLD function is activated, the Current Trace retains the maximum positive video amplitude that occurs during successive frequency sweeps or at the Manual measurement point. This function is useful for observing maximum peak noise or for plotting the frequency drift or positive amplitude drift of a signal over a period of time. In the following figure, for example, the "A" Trace with MAX HOLD displays the frequency drift of a signal during the warmup period of the signal source.

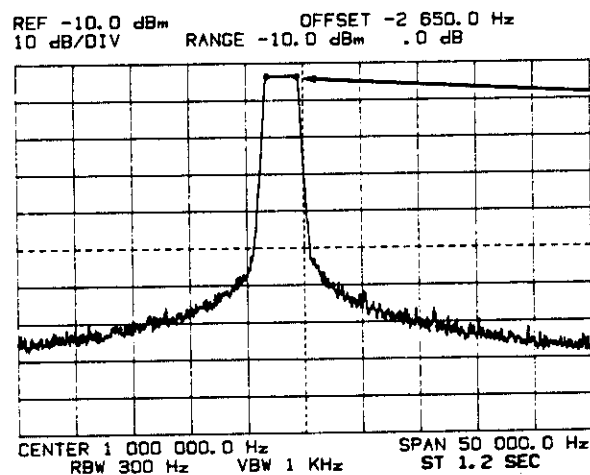

Trace plotted with MAX HOLD shows frequency drift of signal source during its 5-minute warmup.

As indicated by the "OFFSET" readout, the signal source has a negative frequency drift of 2,650 Hz.

TRACE FUNCTIONS

The "A-B" Function



When the  function is activated, the 3585 initially subtracts the contents of Trace Memory "B" from Trace Memory "A" and writes the difference into Trace Memory "A". As a result, the "A" Trace is instantly transformed into "A-B". This subtraction process continues as Trace Memory "A" is updated by the frequency sweep or by the video samples that are taken at the Manual frequency. The "A-B" Trace, therefore, becomes the Current Trace whose amplitude is equal to the "dB difference" between the "A" Trace that would ordinarily be displayed and the stored "B" Trace.

The "A-B" trace is referenced to 0 dB, normally represented by the middle horizontal line on the display graticule. The position of the 0 dB reference line may be changed by activating the display line, positioning it at the desired reference position, and pressing the blue shift key followed by the A-B key (this function is not labeled in blue below the A-B key).

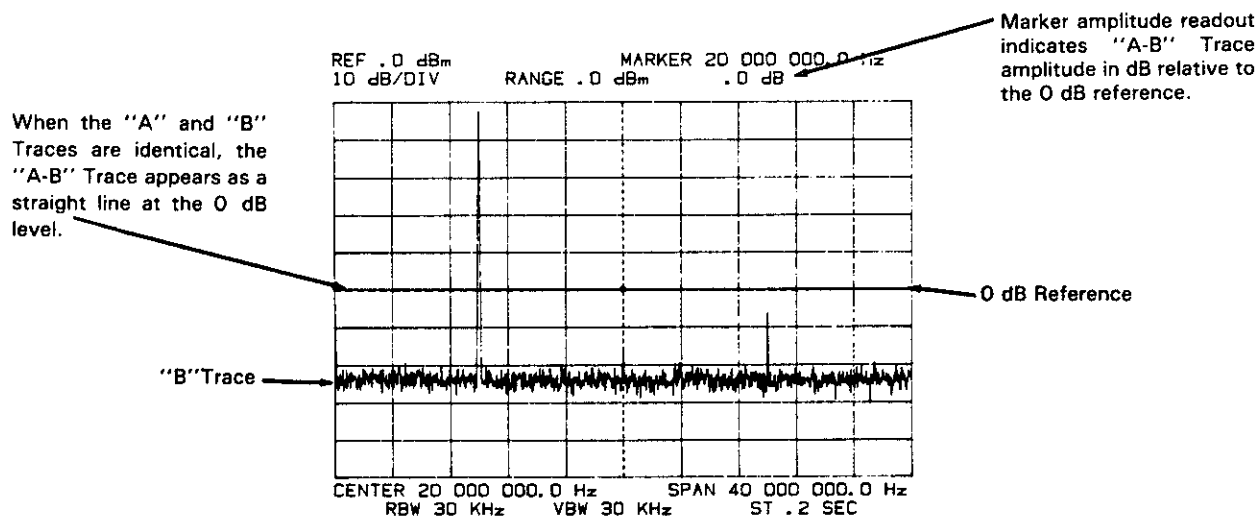

The "A-B" Trace

If the A and B traces are identical, the A-B trace appears as a straight line at the 0 dB level. Positive variations from the 0 dB reference indicate that the amplitude of trace A is larger than that of trace B. The amplitude of the A-B trace may be read from the marker read out in dB.

The "A-B" function will operate whether or not the VIEW A function is activated. However, the VIEW A function *must be activated to display* the "A-B" Trace. Since the "A-B" Trace is stored in Trace Memory "A" and there is no other Trace Memory in which to store the "A" Trace, the "A" and "A-B" Traces cannot be displayed simultaneously. The "B" Trace is independent of the "A-B" function, and can be turned on or off using the VIEW B key.

When the operator deactivates the "A-B" function, the 3585 adds the "B" Trace to the "A-B" Trace and stores the sum ($B + A - B = A$) in Trace Memory "A". Thus, the "A" Trace is instantly returned to the screen.

NOTES

1. To maintain proper display correlation when the "A-B" function is used, the Start Frequency, Stop Frequency, Reference Level and Vertical Scale settings must be the same for the "A", "B" and "A-B" Traces.

2. An "A-B" Trace that exceeds the vertical display range will cause Trace Memory "A" to overflow. If an overflow condition exists when the "A-B" function is deactivated, the "A" Trace that returns to the screen (i.e., $B + (A-B)$) will be distorted. This effect is of little consequence when the analyzer is sweeping rapidly since the "A" Trace will be fully restored after a sweep has been made. However, if the analyzer is sweeping slowly or is not sweeping, the distorted "A" Trace will remain on the screen until it is finally updated by the frequency sweep or cleared from memory.

Applications For "A-B"

The "A-B" function is useful for any application requiring trace comparison. The two most common applications are:

- a. To correct for the frequency response (flatness) variations of the 3585A and its Tracking Generator when measuring the amplitude frequency-response of an external device.

For this application, the 3585 Tracking Generator output is connected directly to the Input that is to be used for measurements. The 3585 is then swept across the spectrum of interest and the resulting plot, showing the flatness variations of the 3585, is stored in "B". Next, the device to be characterized is inserted between the Tracking Generator output and 3585 Input and its response is plotted using the "A-B" function so that the analyzer's response in "B" is subtracted from the measurement. (Procedures for making flatness measurements are given in Chapter 2.)

- b. To simplify the comparison of a test response to a standard response that is stored in "B".

This is particularly useful for production-line applications where a number of networks (e.g., filters) are to be adjusted for identical frequency-response characteristics. For this application, the response of a "production standard" network is plotted and stored in "B". The response of the network under test is then plotted with "A-B" and the network is adjusted so that the "A-B" Trace is a straight line.

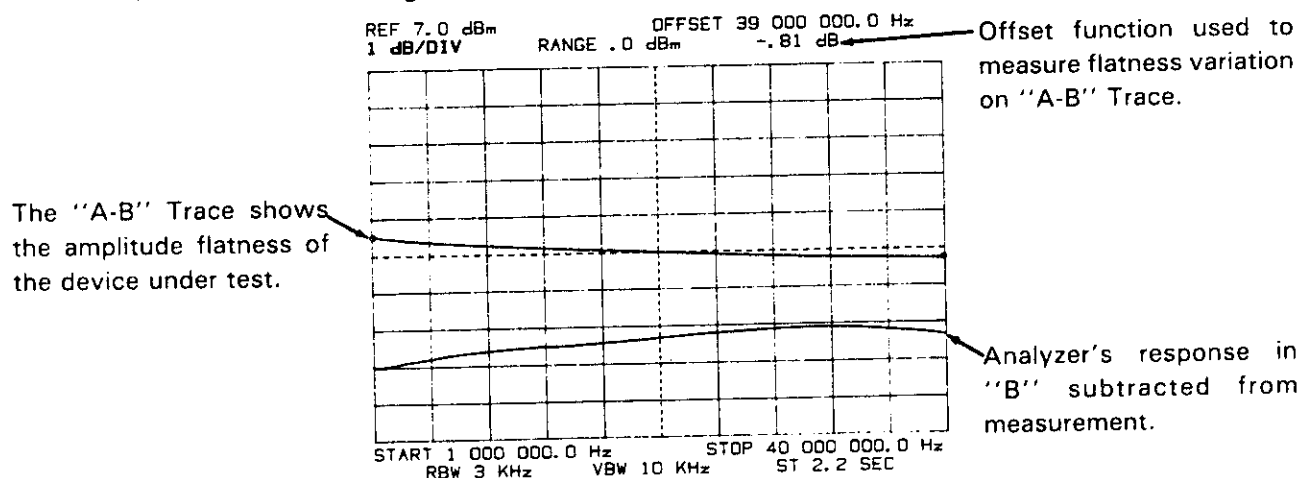



Flatness Measurement With A-B

TRACE FUNCTIONS

Functions That Interact With "A-B"

Note the following:

- a . The  and  functions have the same effect on the "A-B" Trace as they do on the "A" Trace.
- b . An "A-B" Trace can be stored in "B" by pressing  ; but the result may be confusing:
 - 1 . If the "A-B" Trace is stored in "B" while the instrument is sweeping, the "B" Trace will be a duplication of the current "A-B" Trace; and the "A-B" Trace, when updated by the frequency sweep, will become $A - (A-B) = A - A + B$. Thus, the "A-B" Trace will be a reproduction of the original "B" Trace that changes according to the difference between the current "A" Trace and the previous "A" Trace.
 - 2 . If the analyzer is not sweeping, the "B" Trace will be a duplication of the "A-B" Trace and the "A-B" Trace will not be affected.

It is important to note that an "A-B" Trace that has been stored in "B" cannot be measured directly with the Marker because the amplitude readout will indicate the Marker's *absolute* amplitude on the "B" Trace. This can be counteracted by setting the Marker to the 0 dB reference point on the "B" (i.e. stored "A-B") Trace, activating the OFFSET function and pressing the ENTER OFFSET key.
- c . When the analyzer is sweeping or in the Manual mode, the COUNTER function will operate with the "A-B" Trace. The "COUNTER" frequency reading, however, applies *only* to the current "A" Trace which is not displayed.
- d . The 3585 NOISE LVL function will *not* operate when the "A-B" function is activated.
- e . The DISPL LINE function will operate with the "A-B" Trace; but the Display-Line amplitude is displayed in dB relative to the *top* graticule line rather than the middle graticule line to which the "A-B" Trace is referenced.
- f . The OFFSET function can be used to make relative measurements on the "A-B" Trace; but it must be used with care: The 3585 is designed to inhibit Offset measurements between the "A-B" Trace and the "A" or "B" Trace. Valid Offset measurements can be performed on the "A-B" Trace *only* when the Offset is *entered and measured* on that trace.
- g . All other instrument functions will operate in the normal manner; but remember that a change in operating parameters will affect the current "A" Trace but will not affect the stored "B" Trace and will, therefore, change the definition of the "A-B" Trace.

ALPHANUMERIC READOUTS

The alphanumeric readouts that appear on the CRT screen can be divided into three main categories:

a . Parameter Readouts:

Current values of pertinent operating parameters.

b . Frequency and Amplitude Readout:

- 1 . Marker, Counter or Manual frequency; Marker or Manual amplitude; Offset frequency and amplitude.
- 2 . Display-Line amplitude.

c . Operating Messages:

- 1 . Status messages
- 2 . Entry requests
- 3 . Operator error messages
- 4 . Calibration error codes

Parameter Readouts

The 3585 has eight parameter readouts which are used to display the current values of the pertinent operating parameters. The parameter that is prefaced is displayed brighter than the other parameters:

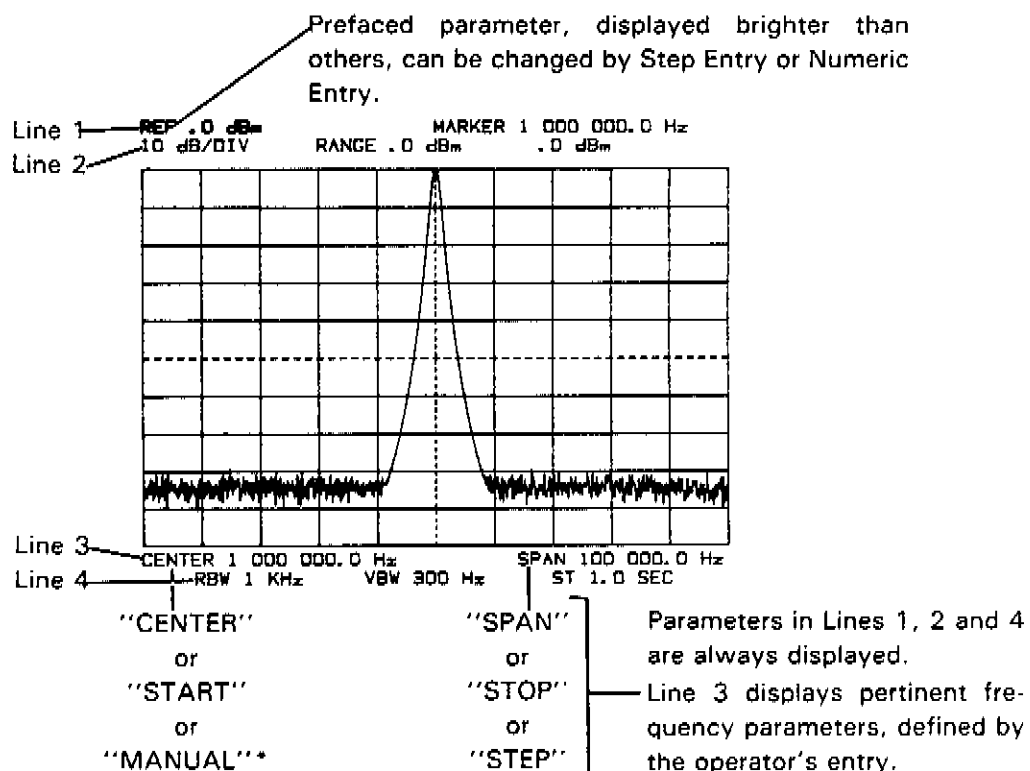

*The Manual frequency is displayed here *only* when it is prefaced. The Manual frequency may also be displayed on the frequency readout in the upper right-hand corner of the screen.

READOUTS

Frequency And Amplitude Readout

The frequency and amplitude readout, located in the top-right corner of the CRT screen, displays *measurement data* obtained using the Marker, Counter, Manual, Offset and Display-Line functions:

- a. All frequency readings (absolute and relative) are displayed in "Hz" with 0.1 Hz resolution.
- b. Absolute amplitude readings are displayed in dBm (50Ω or 75Ω), dBV or rms volts, corresponding to the units in which the Reference Level (and Range) is displayed.
 1. Absolute noise level readings are displayed in dBm (1 Hz), dBV (1 Hz) or $V/\sqrt{\text{Hz}}$.
 2. The resolution for dBm and dBV amplitude readings is 0.1 dB, 0.05 dB, 0.02 dB or 0.01 dB, depending on the Vertical-Scale setting; i.e., 10 dB, 5 dB, 2 dB or 1 dB per-division, respectively.
 3. The resolution for voltage readings is limited to approximately 0.1 dB or 1%.
- c. Relative (Offset, "A-B" or Display-Line) amplitude readings are displayed in dB. Resolution is 0.1 dB, 0.05 dB, 0.02 dB or 0.01 dB, depending on the Vertical Scale setting.

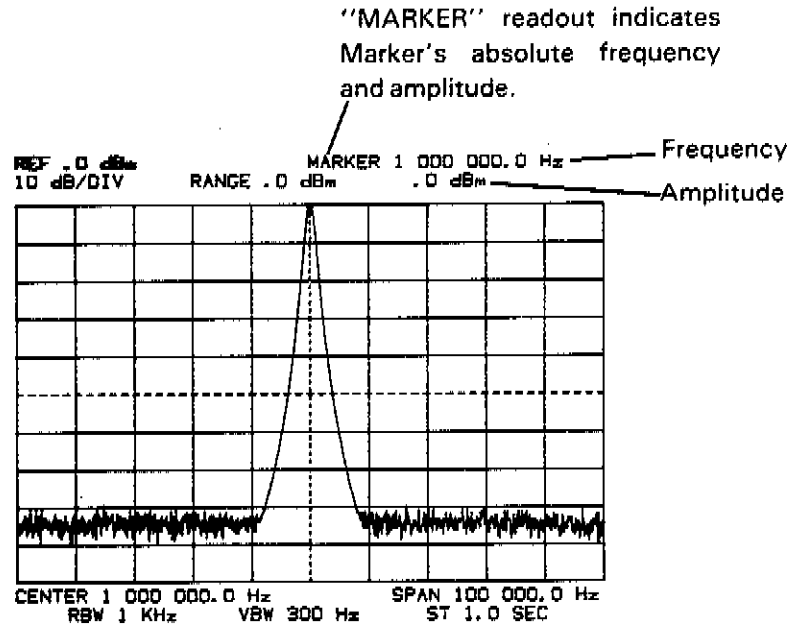







Readouts and Readout Priority

Any one of seven different readouts can be displayed in the top-right corner of the screen. The various readouts and their priorities are as follows:

a. Display Line Amplitude:

Whenever the  function is activated, the "DISPLAY LINE" amplitude (in dB relative to the Reference Level) is displayed in place of all other readouts.

b. Frequency/Amplitude Readouts:

Priority	Readout ( deactivated)	Readout ( activated)	Displayed When:
1	"COUNTER"	"OFS CNTR" (Offset Counter)	 and  activated, Counter triggered by frequency sweep or in Manual mode, Marker or Manual frequency not being changed*
2	"MANUAL"	"OFS MAN" (Offset Manual)	 and/or  deactivated, instrument in Manual mode and Marker at Manual measurement point on CRT trace; or whenever Manual frequency is being changed.
3	"MARKER"	"OFFSET"	requirements for "Counter or "Manual" readout are not met.

*Counter readings are momentarily inhibited when operating parameters are changed and also during Automatic Calibrations. During these periods, the readout reverts to the next lower priority.

NOTES

1. Once the Display Line function has been activated, the display line remains on the screen until the Display Line (blue) Clear key is pressed, the instrument is preset, or power is cycled. If power-up option 3 is active, the display line is saved as part of the instrument state in register 0 when the power is turned off and recalled when power is turned on.
2. The Display Line function can be deactivated by pressing the (blue) Off key of by activating any of the other Continuous Entry functions. When Marker or Manual Sweep is activated, the display line remains on the screen, but the display line readout is replaced by the frequency/amplitude readout. Once the display line readout is replaced, it does not reappear until the display line function is reactivated.
3. Pressing the Display Line (blue) Clear key deactivates the Display Line function (if it is active) and clears the Display Line and its readout from the screen. If the display line readout is displayed when the Clear key is pressed, the readout will go blank and remain blank until Marker or Manual Sweep is activated or the instrument is preset.

READOUTS

Frequency/Amplitude Readout Definitions

a. "MARKER"

Frequency:

Absolute Marker frequency on CRT trace; i.e., the frequency of the point on which the Marker is positioned.

Amplitude:

On "A" or "B" Trace: Marker's absolute amplitude

On "A-B" Trace: Amplitude of "A" in dB relative to "B" at Marker setting.

b. "MANUAL"

Frequency: Current Manual frequency.

Amplitude:

On "A" Trace: Real-time absolute amplitude at Manual frequency.

On "B" Trace: Marker's absolute amplitude on "B" Trace.

On "A-B" Trace: Real-time amplitude at Manual frequency in dB relative to corresponding point on "B" Trace.

c. "COUNTER"

1. Instrument Sweeping:

Frequency:

Absolute frequency of the signal causing the response on which the Marker is positioned. (Counter readings apply only to the "A" Trace which is *not displayed* when "A-B" is activated.)

Amplitude:

On "A" Trace: Absolute amplitude at *Marker* setting.

On "A-B" Trace: Amplitude of "A" in dB relative to "B" at *Marker* setting.

2. In Manual Mode:

Marker At Manual Frequency:

Frequency: Absolute frequency of signal detected at Manual frequency.

Amplitude:

On "A" Trace: Real-time absolute amplitude at Manual frequency.

On "A-B" Trace: Real-time amplitude at Manual frequency in dB relative to corresponding point on "B" Trace.

Marker Not At Manual Frequency:

Frequency: Absolute frequency of input-signal response detected at *Marker* frequency.

Amplitude:

On "A" Trace: Marker's absolute amplitude on the CRT trace.

On "A-B" Trace: Amplitude of "A" relative to "B" at *Marker* setting.

d. "OFFSET"

Current "MARKER" frequency and amplitude relative to frequency and amplitude in Offset Register.

e. "OFS MAN" (Offset Manual)

Current "MANUAL" frequency and amplitude relative to frequency and amplitude in Offset Register.

f. "OFS CNTR" (Offset Counter)

Current "COUNTER" frequency and amplitude relative to frequency and amplitude in Offset Register.

READOUTS

Operating Messages

Operating messages are internally-generated, single-line messages that appear in the upper middle portion of the CRT screen. These messages, indicating instrument status, entry requests, operator errors and calibration error codes, provide a valuable "human interface" between the 3585 and the operator.

Status Messages

"CALIBRATING"

Displayed for the duration of each Automatic Calibration cycle to let the operator know that a calibration is taking place.

"CALIBRATION DISABLED"

Displayed in place of "CALIBRATING" message when Automatic Calibration is disabled.



"BEEPER DISABLED"

Displayed for about 10 seconds after operator initially disables beeper.

"SWEEP SPAN LIMITED"

Appears for 5 to 10 seconds when Center Frequency and Frequency Span parameters are set so that the Start Frequency is lower than 0 Hz or the Stop Frequency is higher than 40.1 MHz. The "out of range" portion of the Current Trace is blanked.



"HP-IB REMOTE SET"

Displayed when the instrument is in Remote and any of the front panel keys except  or  is pressed or the Continuous Entry control is rotated. (The  key is completely ignored when the instrument is in Remote.)

"HP-IB LOCAL LOCKOUT"

Displayed when  key pressed and instrument is in HP-IB Local Lockout mode.

"INSTR. TEST MODE XX"

Displayed continuously (except during Auto. Cal.) when instrument is in a Test Mode. Test Modes 01 through 19 can be activated from the front panel and deactivated by pressing . These Test Modes and all other Test Modes can also be selected with internal switches. If pressing  does not clear a "Test Mode" readout, have a qualified service technician check to be sure that the internal Test Mode switches are in the off position.

"LOCAL OSC. UNLOCKED"

Displayed when any of the instrument's main phase-locked loops becomes unlocked. It is *normal* for this message to be displayed momentarily when the instrument is first turned on; and also when the internal Oven Reference is enabled about ten minutes after turn on or when an external frequency reference is initially connected. Outside of these three normal conditions, the appearance of this message usually indicates an internal failure. However, before sending your instrument in for repair, check to be sure that the BNC-to-BNC jumper is *securely* connected between the rear-panel OVEN REF OUT and EXT REF IN connectors; or, if you are using an external frequency reference, be sure that your reference source is properly connected and is supplying the correct frequency and amplitude (i.e., 10 MHz or any subharmonic down to 1 MHz; 0 dBm to +15 dBm/50 ohms).

The local oscillator loops will lock with *no signal* applied to the EXT REF IN connector. However, if the applied signal is *intermittent* or out of tolerance, the loops will not operate properly.

"COUNTER FAILURE"

Displayed when  activated and internal Counter failure is detected.

"LIMIT TEST ON"
 "LIMIT TEST PASS"
 "LIMIT TEST FAIL"

Indicates status of the Limit Test Function. "ON" is displayed until the end of the first sweep when the limit test is run and the message changes to either "PASS" or "FAIL."

Entry Requests

"ENTER REG. NUMBER"

This message appears when the operator presses the Save or Recall. It remains on the screen until a register number (0 through 9) is entered, the knob is rotated, or any front-panel key is pressed. Entries other than Instrument Preset or digits 0 through 9 terminate the entry sequence and display the "REGISTER UNDEFINED" message.

"ENTER TST #??"

Displayed when operator initiates instrument test mode entry sequence by pressing (blue) 6. To select a test mode, the operator then enters a two-digit number (i.e., 01 through 19). After receiving the test mode number the message appears as "ENTER TST#XX PRESET." The operator then presses Instrument Preset to activate the selected test mode.

NOTE

The Instrument Test Modes, used primarily for adjustments and troubleshooting, are fully defined in the 3585 Service Manual.

READOUTS

Operator Error Messages

If the operator attempts to make an "illegal" entry or initiate a sequence that the 3585 is incapable of executing, the beeper will sound and one of the following error messages will appear on the CRT screen:

ERROR MESSAGE	CAUSED BY:
"OUT OF RANGE"	Entries that exceed the upper or lower limit of a parameter. (Applies to all parameters except Reference Level and minimum sweep rate limit.)
"TOO MANY DIGITS"	Attempts to enter more than the maximum number of digits for a given parameter. The digit that produces the error message is not accepted; but preceding digits are retained and will be accepted if they constitute a valid entry.
"REF < 100 dB BELOW RANGE"	Attempts to set the Reference Level lower than 100 dB below the RANGE setting; or attempts to set the RANGE higher than 100 dB above the Reference Level.
"REF > 10 dB OVER RANGE"	Attempts to set the Reference Level higher than 10 dB above the RANGE setting; or attempts to set the RANGE lower than 10 dB below the Reference Level.
"1,3;10 STEPS ONLY"	Numeric entries that attempt to select unavailable RBW or VBW settings; RBW settings are 3 Hz thru 30 kHz; VBW settings are 1 Hz thru 30 kHz - 1, 3, 10 sequence.
" /DIV = 1;2;5;10 ONLY"	Numeric Vertical Scale (dB/DIV) entries other than 1 dB, 2 dB, 5 dB or 10 dB.
"S.T. IN .2 SEC STEPS"	Numeric Sweep Time entries containing a fractional digit other than 0.2, 0.4, 0.6 or 0.8. (Sweep Time is settable in 0.2 second steps. Illegal fractional digits are accepted; but, when the suffix key is pressed, the fractional digit is automatically incremented by 0.1 second and the error message appears on the screen. The beeper does not sound.)

ERROR MESSAGE

CAUSED BY:

"SWEEP RATE TOO SMALL"	Sweep Time entries that produce a sweep rate slower than 0.1 Hz/sec (30 kHz and 10 kHz RBW) or 0.005 Hz/sec.
"USE STEP KEYS ONLY"	Attempts to set RANGE by Numeric Entry.
"ENTRY MODE UNDEFINED"	Pressing a STEP key or Number/Units key without first prefacing a parameter.
"REGISTER UNDEFINED"	Pressing <input type="button" value="SAVE"/> or <input type="button" value="RECALL"/> followed by any key other than <input type="button" value="INSTR PRESET"/> or digits <input type="button" value="1"/> through <input type="button" value="9"/>
"COUNTER OUT OF LIMIT"	Pressing <input type="button" value="MARK -> CF"/> when "COUNTER" frequency reading is higher than 40.1 MHz.

Calibration Error Codes

During each Automatic Calibration cycle, the 3585 performs a comprehensive algorithm in which frequency and amplitude offsets are measured and corrected and many of the instrument's functional capabilities are verified. If, for any reason, the 3585 is unable to successfully complete an Automatic Calibration, the beeper will sound and a Calibration Error Code (e.g., "CALIBRATION ERROR 03") will appear on the CRT screen. There are 33 Calibration Error Codes, all of which are fully defined in the 3585 Service Manual. The calibration errors are quite explicit and will often lead the service technician directly to the source of trouble.

CHAPTER 7

BANDWIDTH AND SWEEP TIME COUPLING

This chapter describes the operation of the Bandwidth and Sweep-Time coupling system, controlled by the keys located in the RBW-VBW-ST control block.

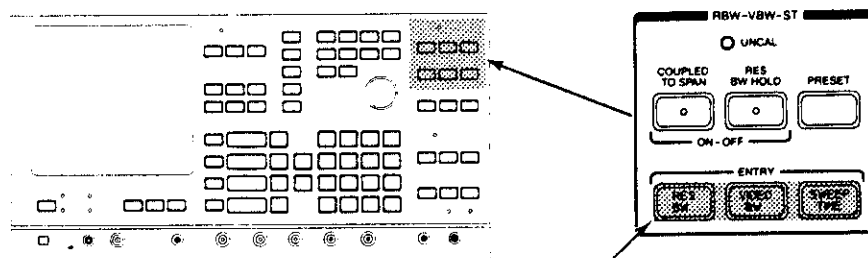

  and  entry functions are described in Chapter 5.



OVERVIEW

 Couples RBW to Frequency Span; couples VBW to RBW; automatically adjusts Sweep Time according to RBW, VBW and Frequency Span.

(Automatically activated by ; press to deactivate, press again to reactivate.)

 Prevents RBW *and* VBW from changing as a function of Frequency Span.

(Press to activate; press again to deactivate.)

 Restores "optimum" RBW, VBW and Sweep Time settings. If  activated, restores optimum VBW and Sweep Time; but does not affect RBW.

 Lights when manually-selected sweep rate is too fast to maintain calibration.

INTRODUCTION TO COUPLING

INTRODUCTION TO COUPLING

Mechanical coupling is commonly used in spectrum analyzers to permit two or more parameters to be simultaneously adjusted with one control knob. For those who are unfamiliar with the concept of coupling, a typical coupled control is described in Figure 1.

The 3585 Bandwidth and Sweep Time coupling system is electronic rather than mechanical. As such, it performs the same basic function as a mechanical system, but it provides greater flexibility and more precise control.

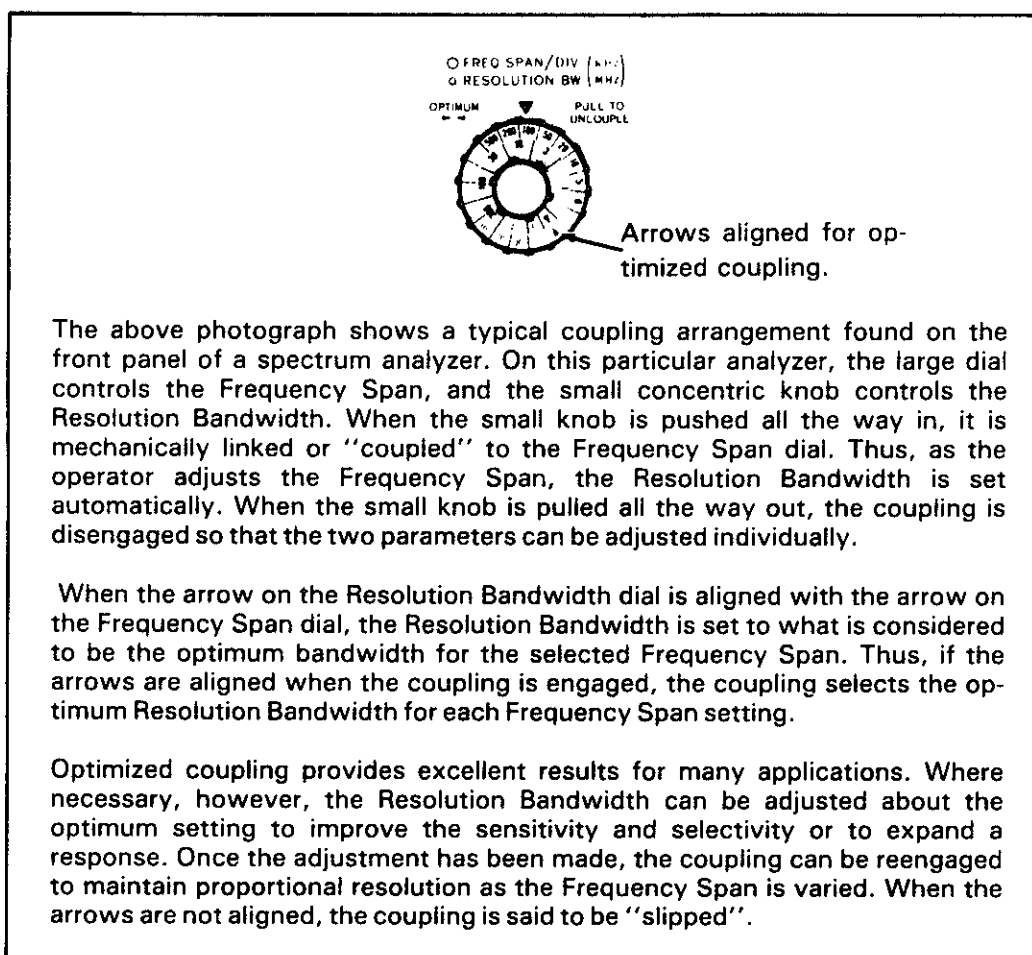







Figure 1. Mechanical Coupling.

OPERATION WITH OPTIMIZED COUPLING



To begin a measurement, the operator normally presses . This activates , deactivates  and sets the Frequency Span to 40 MHz. It also presets the Resolution Bandwidth (RBW) and Video Bandwidth (VBW) to 30 kHz and the Sweep Time to 0.2 seconds. These Bandwidth and Sweep Time settings are the preferred or "optimum" settings for the full 40 MHz Span. Once these settings are established, the Bandwidth and Sweep Time coupling is considered to be "optimized". With optimized coupling, the  function automatically selects the optimum RBW and VBW settings as a function of Frequency Span; and automatically adjusts the Sweep Time to maintain the maximum-calibrated sweep rate. The "optimum" RBW, VBW and Sweep Time settings are not necessarily the best settings for your particular measurement. They are, however, suitable for many general-purpose measurements and they always provide an excellent starting point from which the parameters can be individually adjusted to obtain the required results.

Changing Parameter Values

As described in Chapter 5, the RBW, VBW and Sweep Time settings can be changed by Step Entry or Numeric Entry. It is *not necessary* (or desirable) to deactivate the  function when adjusting the RBW, VBW or Sweep Time settings. The coupling system will allow you to select any available RBW, VBW, ST combination. It will then (if possible) maintain the relationships that you have established. With optimized Sweep Time coupling, the operator can freely select the desired RBW and VBW settings; the Sweep Time is automatically adjusted to maintain the optimum sweep rate.

Preset Key

The PRESET key automatically restores the optimum RBW, VBW and Sweep Time settings. This provides a convenient way to reoptimize the coupling without presetting the entire instrument or individually adjusting the Bandwidth and Sweep Time parameters. Operation is as follows:

- The PRESET key is operative whether or not the  function is activated.
- If the  function is activated, the PRESET key will restore the optimum Video Bandwidth (relative to RBW) and Sweep Time; but it will not change the RBW setting.

DETAILED ASPECTS OF OPERATION

The  function controls two independent but interactive coupling systems:

- Bandwidth Coupling
- Sweep Time Coupling

BANDWIDTH COUPLING

Bandwidth Coupling

With the  function activated, the Video Bandwidth (VBW) is coupled to Resolution Bandwidth (RBW); and Resolution Bandwidth is coupled to Frequency Span. Operation is as follows:

- a. Changing the RBW automatically changes the VBW.* (Changing the VBW does not change the RBW.)
- b. The RBW is set automatically as a function of Frequency Span; i.e., narrowing the Span narrows the RBW. Since the VBW is coupled to RBW, it also changes as a function of Frequency Span. (Again, the coupling does not operate in reverse; changing the RBW and/or VBW does not change the Frequency Span.)

The optimum RBW and VBW settings are listed in Table 1.

The optimum RBW settings maintain a good aspect ratio and generally provide adequate resolution and sensitivity. However, the most suitable RBW setting must ultimately be selected by the operator.

The optimum VBW settings are the narrowest settings that can be used without increasing the Sweep Time. For good video filtering, the VBW should be narrowed to at least 10% of the RBW setting.

Slipped Bandwidth Coupling

Changing the RBW and/or VBW, in effect, "slips" the Bandwidth coupling. Operation with slipped coupling is as follows:

- a. The Resolution Bandwidth changes according to the Frequency Span as outlined in Table 1. The relationship between the operator's RBW setting and the optimum RBW setting is automatically maintained. For example, if the operator narrows the RBW two steps from the optimum setting, the coupling system (where possible) automatically sets the RBW two steps below optimum when the Frequency Span is changed. The coupling system will not attempt to force the RBW to go below 3 Hz or above 30 kHz. Therefore, if the Frequency Span is narrowed to the point where the RBW would go below 3 Hz, the RBW will remain 3 Hz. This does not alter or reoptimize the coupling. The coupling system will *remember* that the RBW should be a given number of steps below optimum and will automatically restore that relationship when the Frequency Span is widened.
- b. The Video Bandwidth changes according to the RBW as shown in Table 1. (Note that the VBW does *not* change when the RBW is changed from 30 kHz to 10 kHz or vice-versa.) The relationship between the operator's VBW setting and the optimum VBW setting is automatically maintained. Again, the coupling system will not attempt to force the VBW to go below 1 Hz or above 30 kHz; but it will remember the number of steps above or below the optimum setting and restore that relationship when the limit is no longer exceeded.



*Except when RBW is changed from 30 kHz to 10 kHz and vice-versa.

Table 1. Optimum RBW/VBW Settings.

Frequency Span	Optimum RBW	Optimum VBW
0 Hz to 199.9 Hz	3 Hz	10 Hz
200.0 Hz to 999.9 Hz	10 Hz	30 Hz
1,000.0 Hz to 4,999.9 Hz	30 Hz	100 Hz
5,000.0 Hz to 19,999.9 Hz	100 Hz	300 Hz
20,000.0 Hz to 99,999.9 Hz	300 Hz	1 kHz
100,000.0 Hz to 499,999.9 Hz	1 kHz	3 kHz
500,000.0 Hz to 1,999,999.9 Hz	3 kHz	10 kHz
2,000,000.0 Hz to 9,999,999.9 Hz	10 kHz	30 kHz
10,000,000.0 Hz to 40,100,000.0 Hz	30 kHz	30 kHz

Resolution Bandwidth Hold Function.



The  function inhibits the RBW coupling and, therefore, prevents the RBW (and VBW) from changing as a function of Frequency Span. (As long as  is activated, VBW remains coupled to RBW.) When the RBW HOLD function is activated, the RBW and VBW settings can still be changed by Step Entry or Numeric Entry; but they will not change automatically and the RBW will not change when the PRESET key is pressed.

Sweep Time Coupling

With the  function activated, the optimum Sweep Time is mathematically calculated according to the Frequency Span, RBW and VBW settings:

Widening the Frequency Span or narrowing the RBW and/or VBW increases the Sweep Time.

(The coupling does not operate in reverse; changing the Sweep time does not affect the Frequency Span, RBW or VBW.)

With optimized Sweep Time coupling, the Sweep Time is (where possible) automatically adjusted to maintain the maximum-calibrated sweep rate. The minimum Sweep Time is 0.2 seconds. If the maximum-calibrated sweep rate is such that the Sweep Time would be less than 0.2 seconds, the Sweep Time is automatically set to 0.2 seconds.

When the instrument is sweeping at the maximum-calibrated rate, the amplitude compression is approximately 0.2 dB and the Frequency skew is about 33 percent of the RBW setting. This dynamic error can be reduced by a factor of four by increasing the Sweep Time two steps from the optimum setting. If the Sweep Time is decreased below the optimum setting, the UNCAL indicator will light to indicate that the instrument is sweeping too fast to maintain calibration.

SWEEP TIME COUPLING

Slipped Sweep Time Coupling

Changing the Sweep Time by Step or Numeric Entry "slips" the Sweep Time coupling. Operation with slipped coupling is as follows:

- a. When the Sweep Time is changed by Step Entry, the coupling system simply remembers the operator's setting in steps above or below the optimum setting and automatically maintains that relationship.
- b. When the Sweep Time is changed by Numeric Entry:
 1. The operator's Sweep Time setting is retained until the Frequency Span, RBW or VBW setting is changed.
 2. When the Frequency Span, RBW or VBW setting is changed, the coupling system converts the operator's Sweep Time to an integral number of steps above or below the optimum setting and maintains that relationship.

Since each Sweep Time step (as in a Step Entry) either multiplies or divides the Sweep Time by 2, the Sweep Time selected by the coupling system will always be 2^N times the optimum setting.

The following formula is used to convert the operator's Sweep Time setting to an integral number of steps above or below the optimum setting:

$$N = \log_2 S$$

Where:

$$N \text{ (rounded off)} = \frac{\text{integral number of steps above or below}}{\text{optimum Sweep Time}}$$

$$S = \frac{\text{Operator's Sweep Time}}{\text{Optimum Sweep Time}}$$

Peculiarities of Slipped Sweep Time Coupling (Numeric Entry)

If the operator's numeric Sweep Time entry is such that "S" is not an integral power of 2, the number "N" will be a decimal or mixed number and will, therefore, be rounded off to the nearest whole number of steps. As a result, the following peculiarities may be observed:

- a. If the operator's Sweep Time entry is less than one half step above or below the optimum setting, the optimum Sweep Time will be restored when the Frequency Span, RBW or VBW is changed.

- b. If the operator's Sweep Time is not an integral number of steps above or below the optimum Sweep Time, a change in Frequency Span, RBW or VBW may not produce a proportional change in Sweep Time:

Example:

Decreasing the RBW by a factor of 10 normally increases the Sweep Time by a factor of 100. However, if the optimum Sweep Time is 0.8 seconds and the operator enters a Sweep Time of 2 seconds and then decrements the RBW by a factor of 10, the Sweep Time will change to 160 seconds rather than 200 seconds. Since 2 seconds is not an integral number of steps above 0.8 seconds, the coupling system, in this case, converts the operator's entry to 1.6 seconds (0.8×2) which, when multiplied by 100, yields a Sweep Time of 160 seconds.*

- c. If the operator enters a Sweep Time, changes the Frequency Span, RBW or VBW and then returns to the original settings, the Sweep Time selected by the coupling system may differ from the operator's original entry.

Example:

Continuing with the preceding example—if the Sweep Time is 160 seconds and the RBW is returned to its original setting, the Sweep Time will change to 1.6 seconds rather than the operator's entry of 2 seconds.

- d. When the Frequency Span, RBW or VBW setting is changed, the operator's Sweep Time will be converted to an integral number of steps above or below the optimum setting *even if the optimum setting does not change*. Consequently, the Sweep Time may increase when it would be expected to decrease.

Example 1:

If the optimum Sweep Time is 2 seconds and the operator enters a Sweep Time of 3 seconds and increments the VBW, the Sweep Time will increase to 4 seconds. With optimized bandwidth coupling, increasing the VBW does not change the optimum Sweep Time. In this case, the optimum Sweep Time remained 2 seconds but, in response to the VBW change, the operator's Sweep Time was converted to one step above optimum.

Example 2:

If the optimum Sweep Time is 0.2 seconds and the operator enters a Sweep Time of 10 seconds, holds the bandwidth and narrows the Frequency Span, the Sweep Time will *increase* to 12.8 seconds. Narrowing the Frequency Span (with bandwidth constant) normally decreases the Sweep Time. In this case, however, the optimum Sweep Time cannot go below 0.2 seconds (minimum 3585 Sweep Time) so the coupling system converted the operator's Sweep Time to an integral number of steps above 0.2 seconds. Due to the rounding off process, a Sweep Time of 10 seconds converts to six steps above 0.2 seconds which is 12.8 seconds. A Sweep Time of 8 seconds, however, would be converted to 5 steps above 0.2 seconds and the Sweep Time would decrease to 6.4 seconds.

*To demonstrate this, press  and decrement the RBW one step to obtain a Sweep Time of 0.8 seconds. Then, enter a Sweep Time of 2 seconds and decrement the RBW two steps.

CHAPTER 8

MARKER/CONTINUOUS-ENTRY FUNCTIONS

The Marker/ Continuous Entry control block contains the Continuous Entry control (knob) and the control keys for 18 special operating functions. While these special functions are not essential for basic instrument operation, they allow you to make measurements faster and with greater accuracy.

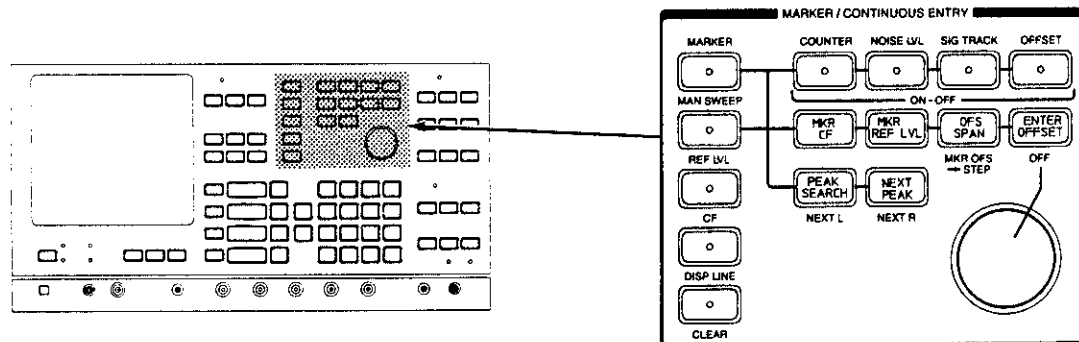

OVERVIEW

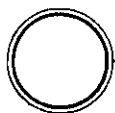

Continuous Entry control: continuous adjustment of Marker frequency, Manual frequency, Reference Level, Center Frequency or Display Line; depending on which Continuous Entry function is activated.



Deactivates Continuous Entry function that is currently activated.



Couples Continuous Entry control to the instrument's tunable Marker to permit the Marker to be moved from point-to-point along the CRT trace.



Selects Manual mode; sets Manual frequency equal to current Marker frequency; couples Continuous Entry control to Manual frequency to permit manual frequency tuning.



Couples Continuous Entry control to Reference Level for continuous Reference Level adjustment. Resolution is 0.1 dB.



Couples Continuous Entry control to Center Frequency to permit Center Frequency tuning. Resolution is 0.1% of Frequency Span or 0.1 Hz.



Places horizontal Display Line on CRT screen; couples Continuous Entry control to Display Line for adjustment of Display-Line amplitude. Display Line readout indicates Display-Line amplitude in "dB" relative to the Reference Level.



Deactivates  function (if activated); clears Display Line from CRT screen, but does not reset Display Line or change its amplitude.



Precisely measures the frequency of the response on which the marker is positioned. Marker must be at least 20 dB above noise and 20 dB above any unresolved signal that is inside the IF filter skirts.



Provides direct readout of rms random noise spectral density (at the Marker or Manual frequency) normalized to a 1 Hz noise power bandwidth. All correction factors are included in the internal noise-measurement routine.



Signal Tracking finds a signal peak near the marker and moves it to the center of the display. It continues to locate a nearby peak and center it, such that if the peak changes frequency, the new peak is centered, until tracking is deactivated. The frequency span must be nonzero and the sweep must be continuous.



Displays difference between frequency in Offset Register and current Marker, Counter or Manual frequency; and "dB" difference between amplitude in Offset Register and current Marker amplitude.



Stores current (absolute) Marker, Counter or Manual frequency and Marker amplitude in Offset Register. (Operative only when  activated.)



Sets Center Frequency equal to current (absolute) Marker, Counter or Manual frequency (whichever is being displayed); and sets Marker to Center-Frequency point on CRT trace.



Sets Reference Level equal to current (absolute) Marker amplitude, indicated by "MARKER" or "MANUAL" readout.



Sets Frequency Span equal to displayed Offset frequency; i.e., the difference between the frequency in the Offset Register and the current Marker, Counter or Manual frequency. (Operative only when  function activated.)



Sets Center Frequency Step Size (also Manual frequency step size) equal to current Marker, Counter, Manual or Offset frequency (whichever is being displayed).



Peak Search moves the marker to the largest trace value on the display. If more than one peak has the same value, the marker moves to the peak at the lowest frequency. Other keys which support Peak Searching are Next Peak, Next Left and Next Right.

DETAILED ASPECTS OF OPERATION

The following discussion is divided into two parts:

- a. Continuous Entry Functions
- b. Marker Functions

The Continuous-Entry functions are described first to provide background information for the various Marker functions.

CONTINUOUS ENTRY FUNCTIONS

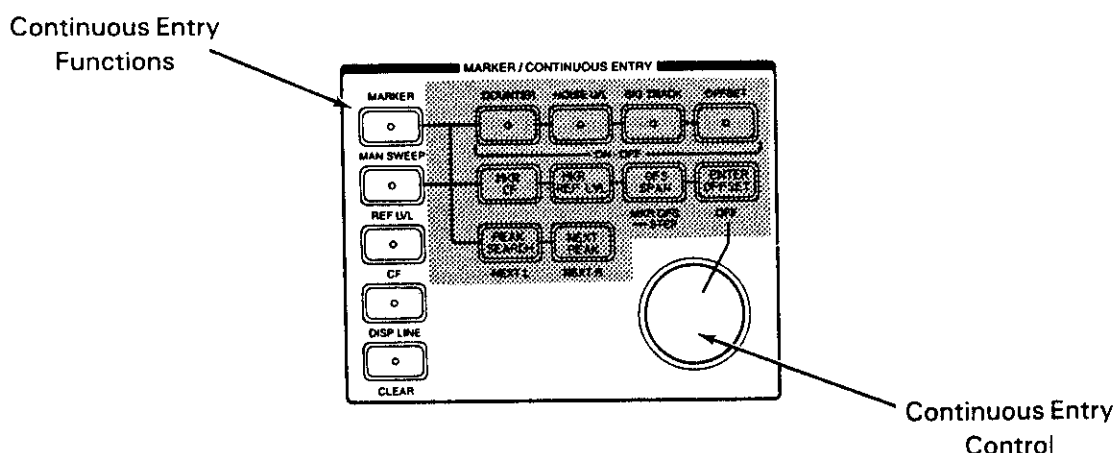

Continuous Entry Control

The Continuous Entry control has the physical appearance and "feel" of an ordinary analog potentiometer. Nevertheless, it is actually a digital device called a "Rotary Pulse Generator" or "RPG". As the Continuous Entry knob is rotated, the RPG generates electrical impulses which, depending on the direction of rotation, either increment (CW) or decrement (CCW) the value of the function or parameter that is under Continuous Entry control. The increment size is internally regulated to maintain comfortable sensitivity and adequate resolution for the parameter being adjusted.

Continuous Entry Function Keys

The Continuous Entry control (knob) allows the user to make parameter changes in an analog fashion, as opposed to numeric keypad entry or stepping values up or down. Rotating the knob may either increment (CW) or decrement (CCW) the value of the selected function or parameter. The increment size is regulated to maintain comfortable sensitivity and adequate resolution for the parameter being adjusted.

The Continuous Entry function keys are aligned vertically along the left-hand edge of the Marker/Continuous Entry control block. Only one of these keys can be activated at a time, and the key that is active determines the parameter of function to which the knob control is coupled. The (blue) Off key (under the Enter Offset key) deactivates the knob so that inadvertent rotation doesn't change the selected parameter.

Marker Function

With the MARKER function activated, the Continuous Entry control is coupled to the instrument's tunable Marker. The tunable Marker, whose frequency and amplitude appears in the upper right-hand corner of the CRT screen, can be used to directly measure the absolute frequency and amplitude of any point on a displayed trace. The Marker can also be used in conjunction with the various Marker/Manual functions to perform relative (Offset) measurements, Counter and Noise Level measurements and change parameter values.

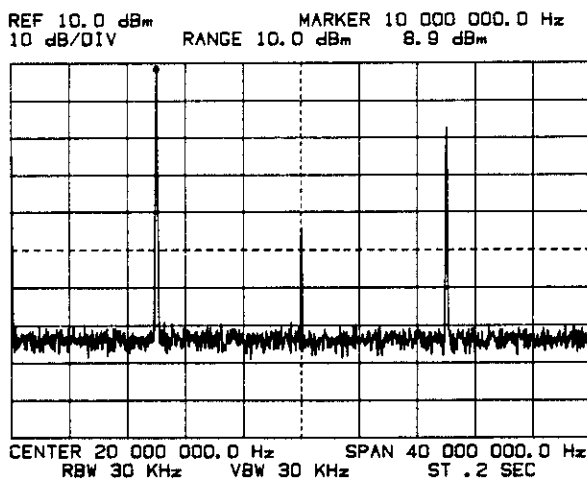



Measure absolute frequency and amplitude of on-screen responses with



The tunable Marker is simply an intensified dot which appears on the CRT trace. As long as the DISPL LINE function is deactivated, the Marker dot is displayed whether or not the MARKER function is activated.

Marker Trace Priority and Amplitude Display Units

The Marker appears on the trace that is selected by the TRACE function keys:

- With  activated, the Marker is displayed on the Current ("A" or "A-B") Trace.
- With  activated and  deactivated, the Marker appears on the "B" Trace.

When the Marker is on the "A" or "B" Trace, its absolute amplitude is displayed in the same units as the Reference Level; i.e., dBm, dBV or rms volts. When the Marker is on the "A-B" Trace, its amplitude, displayed *only* in dB, indicates the amplitude of Trace "A" *relative* to Trace "B".

NOTE

When using the Marker to measure the frequency and amplitude of a stored trace (i.e., the "B" Trace or an "A" or "A-B" Trace that is retained on the CRT screen), the Start Frequency, Stop Frequency, Reference Level and Vertical Scale settings must be the same as they were when the trace was originally plotted. If different settings are used, the Marker's frequency and amplitude will not correspond to the true frequency and amplitude of the points on the stored trace.

Marker Amplitude Resolution and Accuracy

When the Marker amplitude is displayed in dBm, dBV or dB, the amplitude resolution is 0.1 dB, 0.05 dB, 0.02 dB or 0.01 dB, corresponding to the Vertical Scale setting (i.e., 10 dB, 5 dB, 2 dB or 1 dB per-division, respectively).

When the Marker amplitude is displayed in volts, the amplitude resolution is limited to approximately 0.1 dB or 1%. This limitation is the result of the rounding off process that is used in the mathematical conversion from dBV to volts.

The Marker amplitude accuracy is determined by the Reference Level Accuracy and Amplitude Linearity specifications listed in Table 1-1. When the Marker amplitude reading is equal to the Reference Level, the Marker amplitude accuracy is equal to the Reference Level accuracy which includes frequency response, Range and scale errors. When the Marker amplitude is not equal to the Reference Level, the Amplitude Linearity specification must be added to the Reference Level Accuracy specification to determine the Marker accuracy.

Marker Frequency Resolution and Accuracy

The Marker frequency resolution is limited to 0.1% of the Frequency Span (Frequency Span divided by 1,000). This is equal to the frequency spacing between the points on the CRT trace. As the Marker frequency is tuned, the Marker dot jumps from point-to-point along the trace and the Marker readout indicates the frequency and amplitude at each point.

The peak detection system that is used in the 3585 insures that the peak of any response is displayed at a point on the CRT trace. However, the frequency of the point at which the peak is displayed, may differ from the true peak frequency. This limitation can be overcome by:

- a. Using the COUNTER function.
- b. Narrowing the Frequency Span to improve the Marker's frequency resolution and accuracy.
- c. Using the Manual mode to improve the frequency resolution.



The Marker frequency accuracy is:

$$\pm 0.2\% \text{ of Span} + \text{RBW}$$

This worst-case specification reflects the maximum error that will be encountered when using the Marker to measure the frequency of a signal. The specification includes a potential Marker error of $\pm 0.2\%$ of the Frequency Span (i.e., 2 points on the CRT trace) plus a dynamic error equal to the Resolution Bandwidth (RBW) setting. The Marker error accounts for any frequency drift within the instrument and frequency errors caused by the limited Marker resolution and the effects of peak detection. The dynamic error accounts for frequency offsets caused by sweeping. This specification is somewhat conservative: When the instrument is sweeping at the optimum (maximum-calibrated) rate, the frequency offset or "skew" is *typically* about 33 percent of the RBW setting. This frequency skew, directly proportional to sweep rate, can be reduced by a factor of four by *increasing* the Sweep Time two steps from the optimum setting.

Manual Sweep Function



The MAN SWEEP function can be activated by pressing the  key *or* the  key (located in SWEEP block). Pressing either key deactivates the Continuous Entry function that is currently activated; and also deactivates the CONT or SINGLE Sweep function, selects the Manual mode and sets the Manual frequency equal to the current Marker frequency. The MANUAL Entry key prefaces the Manual frequency, enabling it to be changed by Step Entry or Numeric Entry. The MAN SWEEP key couples the Continuous Entry control to the instrument's frequency control system to permit manual frequency tuning.

Once the Manual mode has been selected, the instrument remains in that mode until the CONT or SINGLE Sweep function is reactivated. Reactivating the CONT or SINGLE Sweep function deactivates the MAN SWEEP function and automatically activates the MARKER function.

When operating in the Manual mode, you may deactivate the MAN SWEEP function by pressing the OFF key or by activating a different Continuous Entry function. (Any of the Continuous Entry functions can be used in the Manual mode.) However, the MAN SWEEP function will automatically be reactivated when you preface the Manual Frequency.

Manual Sweep Resolution

The Manual frequency tuning is incremental; but, unlike the normal Marker tuning, the Manual frequency resolution is not limited by the resolution of the point-by-point display. The frequency resolution for the MAN SWEEP function is approximately 3 percent of the Resolution Bandwidth (Table 1) or 0.1% of the Frequency Span (whichever is smaller). Maximum frequency resolution is 0.1 Hz.

Table 1. Manual Tuning Increments (as determined by RBW setting)

Resolution Bandwidth	Increment Size
30 kHz	1 kHz
10 kHz	300 Hz
3 kHz	100 Hz
1 kHz	30 Hz
300 Hz	10 Hz
100 Hz	3 Hz
30 Hz	1 Hz
10 Hz	0.3 Hz
3 Hz	0.1 Hz

As the Manual frequency is tuned by Continuous Entry, the Marker dot jumps from point-to-point on the horizontal axis and deflects vertically to indicate the real-time signal amplitude at the Manual frequency. The resulting trace is plotted (and retained) on the CRT screen. The Manual frequency and amplitude can be read directly from the "MANUAL" readout which appears in place of the Marker readout in the upper right-hand corner of the CRT screen. Manual frequency tuning does not initiate an Automatic Calibration cycle.

Reference Level Function



With the REF LVL function activated, the Reference Level can be manually adjusted from 100 dB below RANGE to 10 dB above RANGE using the Continuous Entry control. Continuous Entry resolution is 0.1 dB for all Vertical Scale (dB/DIV) settings.

Center Frequency Function



The CF function couples the Continuous Entry control to the Center Frequency, enabling the Center Frequency to be manually tuned within the range of 0 Hz to 40.1 MHz. The tuning increments are internally set to 0.1% of the Frequency Span; maximum Center-Frequency resolution is 0.1 Hz. When the Center Frequency is changed by Continuous Entry, the instrument automatically calibrates approximately two seconds after the change is made.

Display-Line Functions



When the DISPL LINE function is initially activated, a horizontal Display Line appears at the bottom of the CRT screen; and the Display-Line amplitude, in dB relative to the Reference Level, is displayed in place of the "MARKER" or other readout in the upper right-hand corner of the screen. With the DISPL LINE function activated, the Display Line can be positioned anywhere on the vertical scale using the Continuous Entry control. The adjustment range and amplitude resolution is determined by the Vertical Scale setting:

VERTICAL SCALE SETTING	DISPL LINE RANGE	DISPL LINE RESOLUTION
10 dB/DIV	100 dB	0.1 dB
5 dB/DIV	50 dB	0.05 dB
2 dB/DIV	20 dB	0.02 dB
1 dB/DIV	10 dB	0.01 dB

The Display-Line function is particularly useful for harmonic distortion measurements where the fundamental is first moved to the top of the screen and the Display Line is then used to measure the harmonics in dB relative to the fundamental. This application is illustrated and described in Chapter 2.

NOTE

None of the Marker functions will operate when DISPL LINE is activated.

Display Line Retained On Screen

Once the Display Line has been position, it remains on the screen until the (blue) Clear key is pressed or the instrument is preset. You may, therefore, deactivate the display line function and use any of the other continuous entry functions without disturbing the display line setting.

When the Display Line is displayed, its amplitude readout may be overwritten by other information, depending on the selection of continuous entry functions.

1. If the display line function is deactivated by pressing Ref Lvl, CF, or (blue) Off, the display line readout continues to be displayed until the (blue) Clear key is pressed or the Marker or Man Sweep function is activated.
2. When the Marker or Man Sweep function is activated, the Marker or Manual information is displayed in place of the display-line readout. The display-line readout does not reappear until the display line function is reactivated.

Changing the Vertical Scale setting will not change the Display-Line position; but it will redefine the Vertical scale and change the Display-Line amplitude reading. For instance if the Vertical Scale is set to 10 dB/DIV and the Display Line is seven divisions below the Reference Level, the Display-Line amplitude will be - 70.0 dB. If the Vertical Scale is then changed to 1 dB/DIV, the Display-Line amplitude will become - 7.00 dB.

The Display Line is strictly a display function and is totally unaffected by a change in the Reference Level or TRACE functions.

NOTE

When the A-B trace is displayed, the display-line amplitude reference is the top graticule line. The A-B trace reference, however, is (usually) the middle graticule line.

Clearing The Display Line

When the display-line (blue) Clear key is pressed, the display line is cleared from the display, but its amplitude value is not erased until the instrument is preset or turned off.¹ Thus, when the display line function is reactivated, the display line reappears at the same amplitude as when the (blue) Clear key was pressed.

Clearing the Display Line does not reactivate MARKER or any of the other Continuous Entry functions. The Marker and its readout will not reappear on the CRT screen until the MARKER or MAN SWEEP function is activated or the instrument is preset.

¹ The display line is retained as part of the instrument state if power-up option 1 or 3 is selected. If 3 is selected, the display line will be active when you power up (if it was active when power was turned off).

MARKER FUNCTIONS

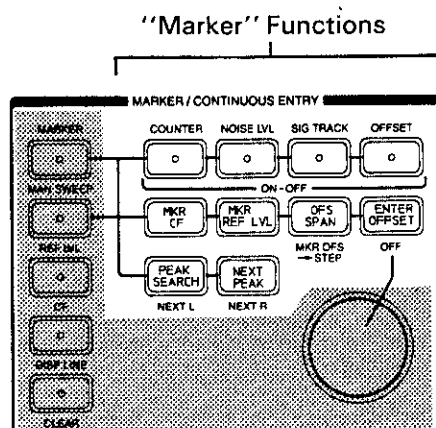

NOTES

1. As indicated by the lines between the ; and "Marker" function keys, the "Marker" functions operate in conjunction with the tunable Marker and in the Manual mode. However, the "Marker" functions are operative whether or not the or function is activated.
2. None of the "Marker" functions will operate when the function is activated.
3. The and functions operate only when the instrument is sweeping or in the Manual mode. They will not operate after a single sweep has terminated. (All other functions remain operative after a single sweep.)
4. The and functions are operative only when the function is activated.

Marker Function Keys

The "Marker" function keys are aligned horizontally in two rows along top of the MARKER/CONTINUOUS ENTRY control block. The ; ; and keys are "OFF-ON" functions; i.e., press once to activate, press again to deactivate. None of these functions are activated by . The remaining keys are momentary-contact functions; e.g., pressing sets the Reference Level equal to the Marker amplitude.

Counter Function

The Marker frequency accuracy is limited by the display resolution and sweep dynamics. To overcome this limitation, the COUNTER function can be used to precisely measure the frequency of the signal that is producing the response on which the Marker is positioned.

To use the COUNTER function, the operator simply sets the Marker at least 20 dB above the noise on the skirt or peak of the response to be measured. The "COUNTER" frequency, displayed in place of the Marker frequency, very accurately indicates the true signal frequency.

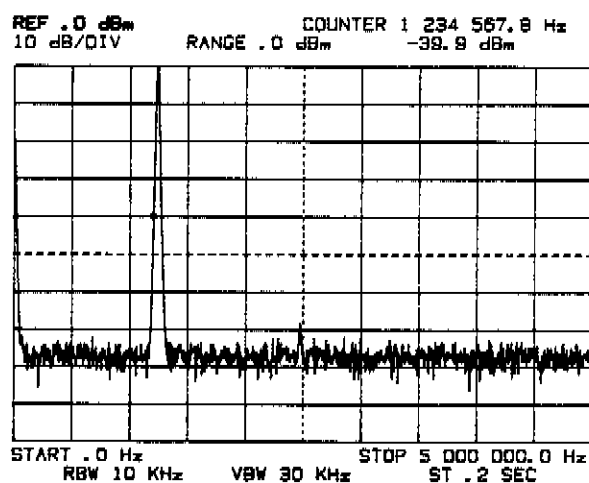

The "COUNTER" readout indicates the true signal frequency which applies to the peak of the response on which the Marker is positioned. (Note that the amplitude readout indicates the *Marker* amplitude rather than the peak amplitude.)

Counter Accuracy

The specified frequency accuracy of the Counter is:

$$\pm 0.3 \text{ Hz} \pm 1 \times 10^{-7} \text{ per month of counted frequency.}$$

This specification applies only when the Marker is at least 20 dB above the noise and 20 dB above any unresolved signal that is inside the IF filter skirts. When an external frequency reference is used, the frequency accuracy of the external reference can be substituted for the internal Oven Reference time coefficient (i.e., $\pm 1 \times 10^{-7}$ per month) in the Counter accuracy specification.

Requirements For Use

To properly use the COUNTER function, the following conditions must exist:

- a. The COUNTER function must be activated.
- b. The DISPL LINE function must be deactivated.
- c. The instrument must either be sweeping or be in the Manual mode.

(The Counter will not operate after a single sweep has terminated.)

- d. The VIEW A Trace function must be activated.

(The Counter reading applies only to the Current ("A" or "A-B") Trace. A counter reading cannot be obtained when the "B" Trace is displayed by itself and Counter measurements cannot be performed on the "B" Trace.)

- e. To obtain an accurate, stable Counter reading, the Marker must be at least 20 dB above the noise and 20 dB above any unresolved response.

(If the Marker is between responses or too near the noise, the Counter reading will be unstable and, in some cases, completely erroneous.)

NOTES

1. When the instrument is sweeping, the counting operation that is performed during each sweep will sometimes produce dynamic "glitching" on the response being measured. This effect is normal and it does not degrade the accuracy of the frequency or amplitude readout.

2. Unstable Counter readings may be encountered in cases where a small response is masked by the skirt of a large response. With the Marker positioned on what appears to be the skirt of a single response, the Counter reading fluctuates as it tries to capture the average frequency of the two responses. If the small response is well hidden, this effect may appear as a Counter malfunction; but it is actually a benefit since it can reveal the presence of a response that might not otherwise be detected. (The responses can be separated and measured individually by narrowing the Resolution Bandwidth.)

Measurement Techniques

The COUNTER function can be used three ways:

- a. With the instrument sweeping.
- b. In the Manual mode with the Marker at the Manual frequency point on the CRT trace.
- c. In the Manual mode with the Marker independently tuned away from the Manual frequency.

Instrument Sweeping

When the instrument is sweeping, the Counter is triggered each time the sweep passes through the Marker frequency. When the sweep reaches the Marker frequency, the sweep stops (for 0.25 to 0.6 seconds) to permit the frequency to be counted. At the end of the counter period, the sweep resumes and the "COUNTER" frequency is displayed in place of the Marker frequency.

The "COUNTER" frequency continues to be displayed and updated by each frequency sweep until the Marker is moved. While the Marker is being tuned, the readout indicates the "MARKER" frequency to assist the operator in locating the response to be measured. When the Marker becomes stationary, the Marker frequency continues to be displayed until the sweep again passes through the Marker frequency and a new "COUNTER" reading is generated.

During a single sweep, the Counter reading is generated or updated when the sweep passes through the Marker frequency. The "COUNTER" reading continues to be displayed after the sweep has terminated. However, once the Marker is moved, the display reverts to "MARKER" and a Counter reading cannot be obtained until another sweep is made.

During swept measurements, the time required to obtain a counter reading depends largely on the Sweep Time value. Once the counter has been triggered by the frequency sweep, the actual counting operation takes anywhere from 0.25 seconds to 0.6 seconds, depending on the frequency difference between the marker and the peak of the response being measured. When the marker is on the noise floor where accurate readings cannot be obtained, the sweep is delayed by approximately 0.5 seconds while the counter tries to capture the frequency of the random noise.

Manual Mode*

In the Manual mode, Counter measurements can be performed at the Manual frequency or at the Marker frequency with the Marker independently tuned away from the Manual frequency point. One major advantage of the Manual mode is that Counter measurements can be made in "real-time" without waiting for a frequency sweep. The Counter is triggered continuously at a rate proportional to the Counter period. Again, the Counter period varies from approximately 0.25 seconds to 0.6 seconds, depending on the frequency difference between the Marker and the peak of the response being measured.

*See Chapter 3 for details concerning the use of the Counter in the Manual mode.

Performance Tests

Harmonic Distortion

m. Set 339A:

Frequency 6.4 kHz⁽¹⁾
Output Level 0.3 V

n. Set 3585B:

Instrument Preset
Stop Freq 20 kHz
Blue (shift) Cal Off⁽²⁾
Manual Entry 6.4 kHz⁽¹⁾
Res BW 300 Hz
Video BW 1 Hz
Counter On
(blue) Mkr Ofs→ Step
Range -15 dBm⁽³⁾
Blue (shift) Cal On⁽⁴⁾
Manual Entry 0 Hz
Manual Entry Step Up
Counter Off

o. Adjust the 339A until the marker amplitude reads -15 dBm.

p. Set 3585B:

Offset On
Enter Offset

q. Set 3585B:

Manual Entry Step Up

r. Read Marker amplitude this is the 2nd harmonic. Compare the value with the spec and record on Performance Test Card.

(1) From the test card.



(2) Save 4 for the 3583A.

(3) Use the up/down-arrow keys to change this parameter.

(4) Recall 4 for the 3585A.

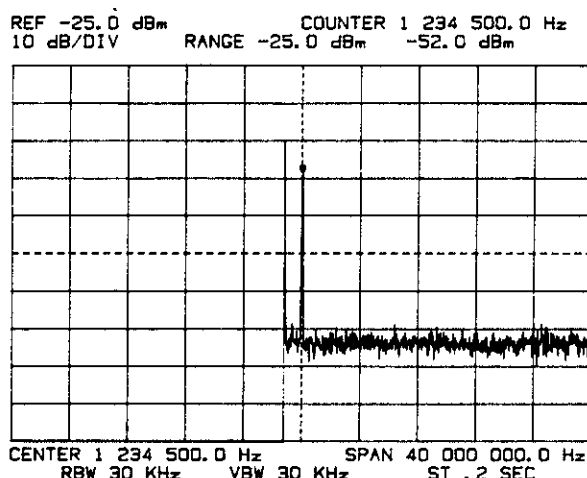
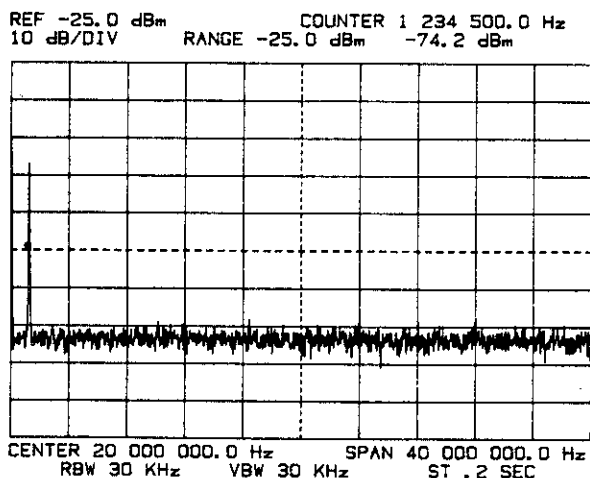
USE  AND  TO QUICKLY ZOOM-IN ON A SIGNAL OF INTEREST:



a. With  and  activated, set Marker on skirt or peak of response; allow time for "COUNTER" reading to appear.

b. Move response to center of screen by pressing .

(This sets Center Frequency equal to "COUNTER", and automatically places Marker at Center-Frequency point.)

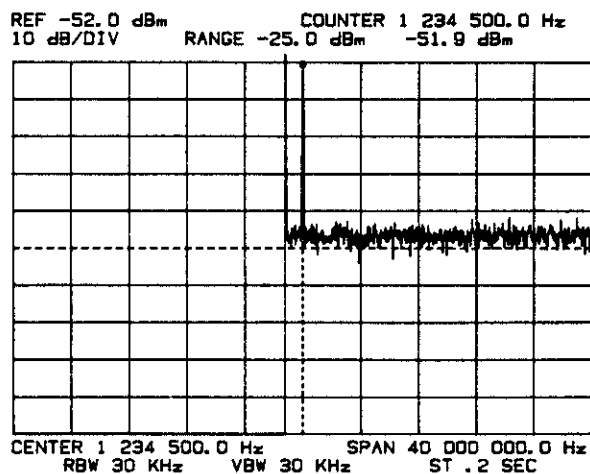

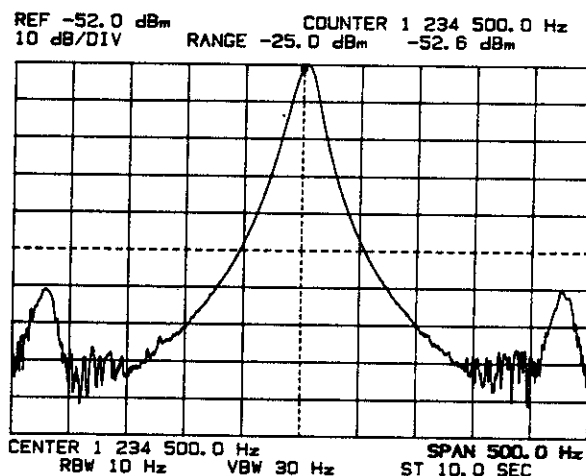

c. Move response to top of screen by pressing .





d. Narrow Frequency Span to obtain required resolution.

(The response is skewed slightly off center due to sweep dynamics.)

Marker To Reference Level Function

Pressing the  key sets the Reference Level (top graticule line) equal to the current absolute Marker amplitude on the CRT trace. This function allows you to very rapidly move a response to the top of the screen where it can be measured with higher amplitude accuracy and/or expanded vertically by reducing the Vertical Scale (dB/DIV) setting. The procedure for using the  function is as follows:



- a. Set the Marker to the desired Reference Level amplitude on the CRT trace or to the peak of a response that is to be moved to the top of the screen.
- b. Press .
- c. If desired, expand the response vertically with  .

Effect Of Scale Errors



When a low-level response is moved to the top of the screen using the  function, the peak of the response may arrive at a point slightly above or below the top graticule line. This effect is caused by non-linearity in the vertical scale:

For example, if the Reference Level is set to 0 dBm, a response whose peak amplitude is -65.0 dBm could, under worst-case conditions, measure -64.0 dBm. Pressing  (with the Marker set to the peak of the response) would set the Reference Level to -64.0 dBm, causing the response to move to the top of the screen. At that point, however, the worst-case scale error is only ± 0.5 dB; so the peak of the -65.0 dBm response would appear somewhere between -64.5 dBm and -65.5 dBm, which is *below* the 64.0 dBm Reference Level. Because of this potential error, the amplitude of a full-scale response should always be read from the *Marker* readout, *not* the Reference Level readout.

Functional Capabilities



The  function will operate with the instrument sweeping, in the Manual mode or after a single sweep has terminated. No matter which trace the Marker is on, the  function sets the Reference Level equal to the absolute Marker amplitude. Keep in mind, however, that a stored trace is totally unaffected by the Reference Level or any other parameter. A response that is on a stored trace cannot be moved to the top of the screen. When the instrument is sweeping, points on the CRT trace will reflect a change in the Reference Level *only* as they are updated by the frequency sweep. In the Manual mode, the Manual measurement point is the only point on the trace that is updated and is, therefore, the only point that will reflect a change in the Reference Level.

A response whose peak is above the Reference Level can be moved down to the top graticule line using the  function; but this capability is limited:

The Marker's amplitude range extends approximately 0.2 divisions above the Reference Level.* If the peak of a response is within the Marker's amplitude range, that peak can be moved down to the top graticule line by pressing  one time. On the other hand, if the peak is above the Marker's amplitude range, pressing  will merely increment the Reference Level in 0.2-division steps. Since it may take dozens of steps to finally move the peak of a high-level response onto the screen, it is generally preferable to increment the Reference Level using the STEP keys or adjust it with the Continuous Entry control.

*0.2 divisions = 2 dB, 1 dB, 0.4 dB or 0.2 dB; depending on the Vertical Scale setting.





Offset Function

The OFFSET function can be used to measure the relative frequency and amplitude between any two points within the measurement range of the instrument. It can also be used with the  function for making signal-to-noise ratio measurements and with the  and  functions to set the Frequency Span and Center-Frequency Step Size.

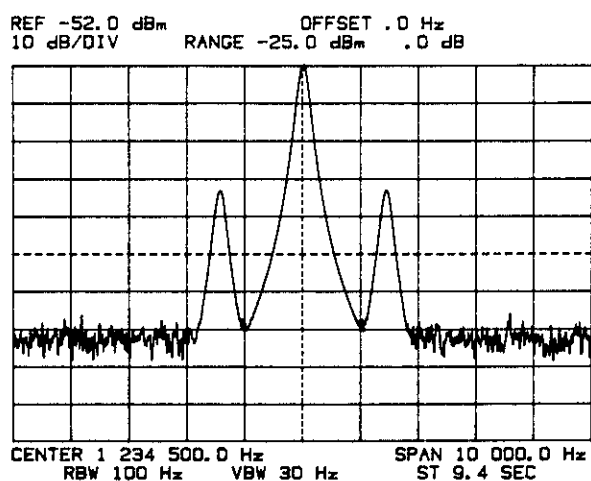
Basic Offset Measurements

The primary purpose of the OFFSET function is to provide an easy way to measure the relative frequency and amplitude between two points on a given trace. The procedure for making this basic Offset measurement is as follows:



- a. Set the Marker to the desired reference point with   . Activate  and then press .

(This stores the "MARKER" frequency and amplitude in the Offset Register.)

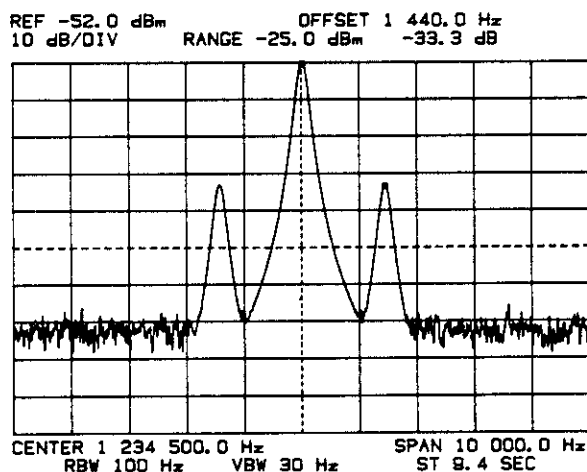

- b. Set the Marker to the point of interest on the trace and observe the "OFFSET" reading.

Offset Readings

When the  key is pressed, the Marker's frequency and amplitude is stored in the instrument's Offset Register. The frequency and amplitude in the Offset Register is then algebraically subtracted from the current Marker reading to produce the "OFFSET" reading. The "OFFSET" reading, therefore, indicates the Marker's current frequency and amplitude *relative* to the frequency and amplitude in the Offset Register.

Offset readings are displayed in place of the normal Marker readings in the upper right-hand corner of the CRT screen. The Offset frequency is displayed in "Hz" with 0.1 Hz resolution; the Offset amplitude is displayed in "dB" (it cannot be displayed in volts). Offset amplitude resolution is 0.1 dB, 0.05 dB, 0.02 dB or 0.01 dB, corresponding to the Vertical Scale setting.

The Stationary Marker

When the tunable Marker is moved away from the reference point (i.e., the point where  pressed), a stationary marker dot remains at that point. The stationary marker normally provides a convenient visual indication of the Offset reference, but it can be deceiving:

- a. The stationary marker appears at the point on the CRT trace that represents the frequency in the Offset Register. However, the amplitude of the stationary marker is determined entirely by the amplitude of the *trace* on which it is displayed. As long as the trace amplitude does not change, the stationary marker will provide an accurate indication of the reference amplitude. If the amplitude of the trace changes, however, the amplitude of the stationary marker will also change and will no longer represent the reference amplitude.

Offset amplitude readings are calculated according to the amplitude that is in the *Offset Register* and are totally unaffected by the amplitude of the stationary marker dot.

- b. When the tunable Marker is on the skirt of a response and the COUNTER function is activated, the "COUNTER" frequency readout indicates the frequency at the peak of the response. When the ENTER OFFSET key is pressed, the "COUNTER" frequency is stored in the Offset Register and the stationary marker appears at the *peak* of the response. However, the amplitude that is stored in the Offset Register is the amplitude of the *tunable Marker*, rather than the peak amplitude indicated by the stationary Marker.

When entering Offsets using the COUNTER function, always set the tunable Marker to the peak of the response; unless you are making special measurements where it is necessary to store a specific Marker amplitude.

Stationary Marker Not Needed To Make Offset Measurements

Since Offset readings are calculated according to the reference parameters that are stored in the Offset Register, valid Offset readings can be obtained whether or not the stationary marker is on the screen. For example, the display in Figure A shows the spectral components of a 10 MHz square wave. With the Offset reference set to the peak of the fundamental and the tunable Marker set to the peak of the third harmonic, the "OFFSET" reading indicates the frequency and amplitude of the third harmonic relative to the fundamental.

In Figure B, the Center Frequency and Span have been changed so that only the third harmonic is being displayed. Even though the stationary marker is no longer on the screen, the "OFFSET" reading still indicates the frequency and amplitude of the harmonic relative to the fundamental frequency and amplitude in the Offset Register.

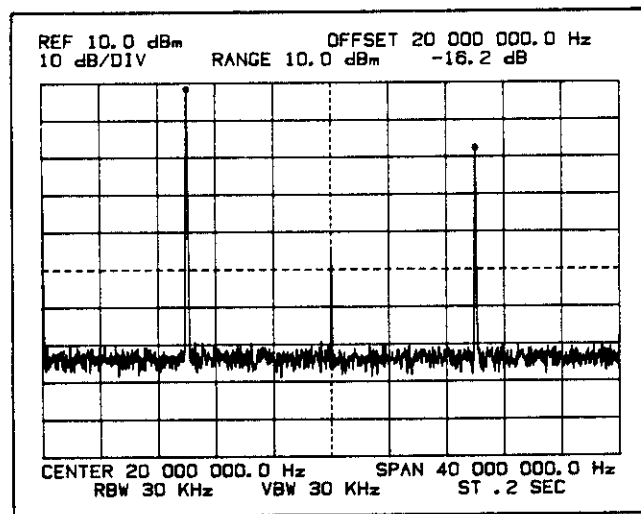

"OFFSET" reading indicates frequency and amplitude of third harmonic relative to 10 MHz fundamental.

Figure A.

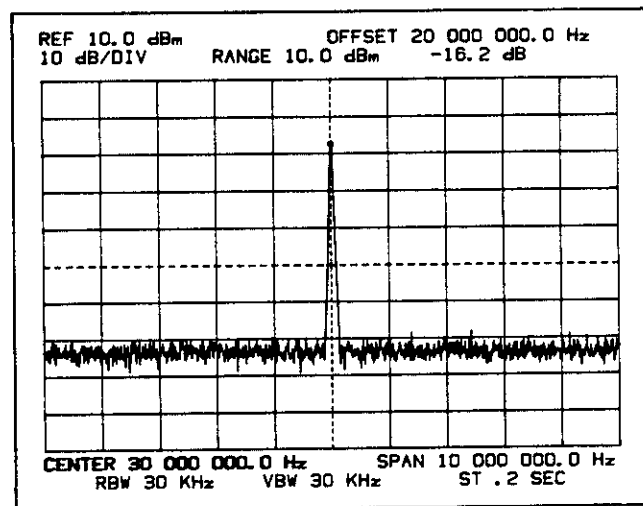

Stationary Marker no longer displayed; but "OFFSET" reading still indicates frequency and amplitude of third harmonic relative to fundamental frequency and amplitude in Offset Register.

Figure B.

Offset Entry Techniques

When the instrument is first turned on or  is pressed, the Offset Register is automatically set to 0 Hz and 0 dBV. Offsets can be entered *only* when the OFFSET function is activated. Once an Offset has been entered, it is retained in the Offset Register until a different Offset is entered or until the instrument is preset or turned off.

When the  key is pressed, the *amplitude* that is stored in the Offset Register is one of the following:

- a. The *absolute* Marker amplitude on the CRT trace.
- b. The absolute real-time amplitude at the Manual frequency.

(When the instrument is in the Manual mode and the Marker is at the Manual measurement point on the CRT trace.)

- c. When the  TRACE function is activated, *two* amplitude values are stored in the Offset Register:

1. The "dB" amplitude of the "A-B" Trace at the Marker or Manual frequency (whether or not the "A-B" Trace is being displayed).
2. The absolute amplitude of the "B" Trace at the Marker setting.

The "A-B" amplitude is used as the Offset reference only when the "A-B" Trace is displayed. If the Marker is on the "B" Trace (i.e., the "B" Trace is displayed by itself) or, if the A-B function is deactivated after the Offset is entered and the Marker appears on the "A" Trace, the "B" Trace amplitude automatically becomes the Offset reference. For this reason, you cannot enter an Offset on the "A-B" Trace and make an Offset measurement between "A-B" and "B" or "A-B" and "A".

Once an Offset has been entered with the A-B function activated, the instrument will (until it is preset) continue to store two amplitude values each time the ENTER OFFSET key is pressed:





When the Marker is on the "A" Trace, the "A" and "A-B" amplitude values are stored in the Offset Register.

When the Marker is on the "B" Trace, the "B" and "A-B" amplitude values are stored in the Offset Register.



Offset measurements on the "A-B" Trace are relative to the "A-B" Offset reference and Offset measurements on the "A" or "B" Trace are relative to the absolute "A" or "B" Offset Reference. This completely inhibits Offset amplitude measurements between the "A" or "B" Trace and the "A-B" Trace.

The frequency that is stored in the Offset Register is the absolute "MARKER", "COUNTER" or "MANUAL" frequency, depending on which functions are currently activated. Entry techniques are as follows:

a. With COUNTER *deactivated*:



1. Set the Marker to the desired reference frequency with   ; activate  and then press .

(This sets the Offset Reference equal to the "MARKER" frequency and amplitude. This technique can be used with the instrument sweeping, in the Manual mode or after a single sweep has terminated.)

2. Set the Manual frequency to the desired reference point, activate  and then press .

(The Marker automatically tracks the Manual frequency tuning. Pressing  sets the Offset Register equal to the current "MANUAL" frequency and amplitude.)

b. With COUNTER activated:

1. Set the tunable Marker or Manual frequency so that the Marker is at the *peak* of the response that is to become the reference. Activate  and then press .

(When  is pressed, the "COUNTER" frequency is stored in the Offset Register and the stationary marker appears at the peak of the response. However, it is the amplitude of the *tunable Marker* that is stored in the Offset Register.)

Offset Measurement Techniques

When the instrument calculates an Offset reading, it doesn't care how the offset was entered. It simply subtracts the frequency and appropriate amplitude value in the Offset Register from the current Marker, Manual or Counter reading. You may, therefore, enter an offset using any one of the techniques previously described and then make your offset measurement using the same technique or a different technique:

a. With COUNTER *deactivated*:

1. Set the Marker to the point of interest on the displayed trace with  and observe the "OFFSET" reading.

(The "OFFSET" readout indicates the current *Marker* frequency and amplitude relative to the frequency and amplitude in the Offset Register. This technique can be used when the instrument is sweeping, in the Manual mode or after a single sweep has terminated. It can also be used to measure offsets on the "B" Trace.)

2. Set the Manual frequency to the point of interest and observe the "OFS MAN" (Offset Manual) reading.

(The "OFS MAN" readout indicates the current *Manual* frequency and amplitude relative to the frequency and amplitude in the Offset Register.)

b. With COUNTER activated:

1. Set the Marker or Manual frequency so that the Marker is at the *peak* of the response to be measured. Observe the "OFS CNTR" (Offset Counter) reading.



(The "OFS CNTR" readout indicates the *Counter* frequency and *Marker* amplitude relative to the frequency and amplitude in the Offset Register. If the Marker is not at the *peak* of the response, the frequency reading will apply to the peak; but the amplitude reading will apply to the *Marker* setting.)

REMINDER

The Counter will operate only when the instrument is sweeping or in the Manual mode. To obtain accurate, stable counter readings, the Marker (or real-time amplitude at Marker frequency) must be at least 20 dB above the noise and 20 dB above any unresolved response. The Counter cannot be used to enter or measure offsets on a stored trace.

Offset Trace Priority and Offsets Between Traces

Offset measurements can be performed on the Current ("A" or "A-B") Trace, the "B" Trace or between the "A" Trace and the "B" Trace. As previously described, Offset amplitude measurements *cannot* be performed between the "A-B" Trace and the "A" or "B" Trace:

- a. With  activated, the Marker appears on the "A" or "A-B" Trace, thus enabling offsets to be entered and/or measured on that trace.
- b. With  activated and  deactivated, the Marker appears on the "B" Trace, allowing offsets to be entered and/or measured on that trace.

NOTES

1. *When entering or measuring offsets on a stored trace (i.e., the "B" Trace or a Current Trace that has been retained on the CRT), be sure that the Start Frequency, Stop Frequency Reference Level and Vertical Scale settings are the same as they were when the trace was originally plotted.*

(If the frequency or amplitude parameters differ from the ones that were used when the trace was plotted, the Marker's absolute frequency and amplitude will not correspond to the displayed trace and, in most cases, errors will be encountered in the Offset measurement.)

2. *Do not store an "A-B" Trace in "B" and attempt to measure offsets between the stored "A-B" Trace and a different trace.*

(When the "A-B" Trace is displayed in "B", the Marker amplitude reading, from which the Offset reading is calculated, is the absolute Marker amplitude on the "B" Trace; not the relative amplitude between "A" and "B". Measurements between a stored "A-B" Trace and a different trace are normally meaningless. Valid offset measurements can be performed on a Current or stored "A-B" trace as long as the Offset is entered and measured on that trace.)

Offsets can be measured between traces "A" and "B"; but *only* when both traces represent absolute frequency and amplitude. While relative amplitude measurements can be made between Traces "A" and "B" using the "A-B" TRACE function, the "A-B" function is applicable only when the frequencies of the two traces correspond. The OFFSET function can be used to measure the relative frequency and amplitude between any two points on the two traces, regardless of their frequency relationship. General procedures for measuring offsets between Traces "A" and "B" are as follows:

- a. To measure a point on "A" relative to a point on "B" (i.e., "A" - "B"):
 1. With VIEW B activated and VIEW A deactivated, set the Marker to the desired reference point on Trace "B", activate OFFSET and then press ENTER OFFSET.
 2. With the VIEW A function activated (A-B function deactivated), set the Marker to the point of interest on the "A" Trace and observe the offset reading.





REMINDER

When entering or measuring offsets on the "B" Trace, be sure the Start Frequency, Stop Frequency, Reference Level and Vertical Scale settings are the same as they were when the trace was originally plotted.

- b. To measure a point on "B" relative to a point on "A" (i.e., "B" - "A"):
 1. With VIEW A activated (A-B deactivated), set the Marker to the desired reference point on Trace "A", activate OFFSET and then press ENTER OFFSET .
 2. With VIEW B activated and VIEW A deactivated, set the Marker to the point of interest on Trace "B" and observe the offset reading.

Offset To Span Function

The Offset to Span function permits the operator to set the Start and Stop frequencies of the Span using the Marker, Counter or Manual function. This feature is particularly useful for narrowing the Span to magnify portions of the spectrum or for "zooming-in" on a particular response. The basic procedure for using the Offset to Span function is as follows:

- a. Set the Marker to the desired Start (or Stop) Frequency with  .
- b. Activate  and then press .
- c. Set the Marker to the desired Stop (or Start) Frequency and press .

The Offset to Span function is operative only when the OFFSET function is activated. Pressing the  key sets the Frequency Span equal to the "OFFSET", "OFS MAN" or "OFS CNTR" frequency, whichever is currently being displayed. The Start and Stop frequencies are set equal to:

Readout	Start/Stop
"OFFSET"	frequency in Offset Register and current <i>Marker</i> frequency.
"OFS MAN"	frequency in Offset Register and current <i>Manual</i> frequency.
"OFS CNTR"	frequency in Offset Register and current <i>Counter</i> frequency.

The Start Frequency is automatically set equal to the lower of the two frequencies.

Operation In Manual Mode And With Counter

General procedures for using the Offset to Span function in the Manual mode and with the Counter are as follows:

a. In the Manual mode:

1. Set the Manual frequency to the desired Start Frequency (or Stop Frequency).
2. Activate the OFFSET function and press the ENTER OFFSET key.
3. Set the Manual frequency to the desired Stop Frequency (or Start Frequency).
4. Press  .

b. With the Counter:

1. With the COUNTER function activated, set the tunable Marker or Manual frequency so that the marker dot is at least 20 dB above the noise floor on the skirt of the response whose peak is to become the Start (or Stop) Frequency.
2. Allow time for the Counter reading to be updated. Activate the OFFSET function and press the ENTER OFFSET key.
3. If the Stop (or Start) Frequency is at the peak of a response, leave the COUNTER function activated; if not, deactivate the COUNTER function.
4. If the COUNTER function is activated: Set the tunable Marker or Manual frequency so that the marker dot is at least 20 dB above the noise floor on the skirt of the response whose peak is to become the Stop (or Start) Frequency. Allow time for the Counter reading to be updated and press  .

If the COUNTER function is deactivated: Set the tunable Marker or Manual frequency to the desired Stop (or Start) Frequency and press  .

Marker-Offset To Step Function

Pressing the  key sets the Center Frequency Step Size equal to the frequency that is currently being displayed in the upper right-hand corner of the CRT screen:

Readout	Center Frequency Step Size
“MARKER”	current absolute Marker frequency.
“COUNTER”	absolute frequency at peak of response on which the Marker is positioned.
“MANUAL”	the frequency to which the analyzer is tuned in the Manual mode.
“OFFSET”	difference between current <i>Marker</i> frequency and frequency in Offset Register.
“OFS CNTR”	difference between current <i>Counter</i> frequency and frequency in Offset Register.
“OFS MAN”	difference between current <i>Manual</i> frequency and frequency in Offset Register.

The Center Frequency or Manual frequency can be incremented or decremented in steps equal to the Center-Frequency Step Size using the STEP keys. The ability to step the Center or Manual frequency allows you to quickly and easily measure signals that are equally spaced in frequency; and the Marker-Offset to Step function provides a very convenient way to enter the step size. Procedures for using the Marker-Offset to Step function are included in Chapters 2 and 3.

Noise Level Function



Random noise spectral density measurements can be performed with almost any analyzer having good sensitivity, a well-defined selectivity characteristic and a narrow-band video filter. However, the normal procedures for making these measurements require time-consuming calculations and a considerable amount of painstaking effort on the part of the operator. With the 3585 NOISE LVL function, all of the work is done automatically. The operator simply sets the tunable Marker to the point of interest on the noise to be measured, activates the NOISE LVL function and observes the noise density reading which appears in place of the Marker amplitude in the upper right-hand corner of the CRT screen:

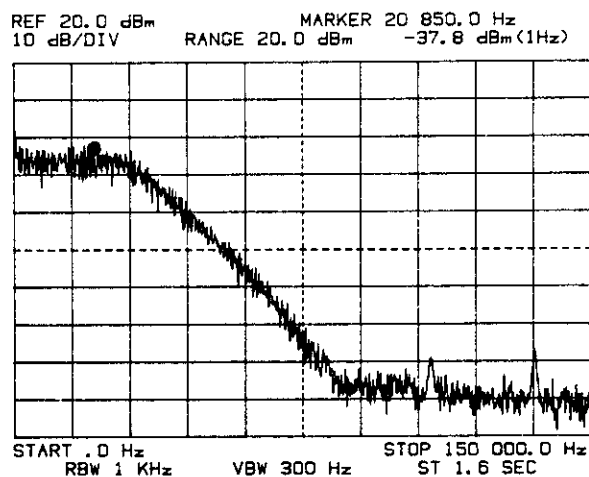

Noise level "dBm (1 Hz)" reading in top-right corner of screen indicates rms random noise spectral density at Marker, normalized to a 1 Hz noise power bandwidth.

CAUTION

To avoid damaging the instrument, the noise power applied to the Terminated input must not exceed 1 watt; and the broadband noise level applied to the High-Impedance input must not exceed 3.7V rms.

WHAT RANDOM NOISE SPECTRAL DENSITY IS:

A complex random noise signal theoretically consists of an infinite number of frequency components, each contributing an infinitesimal amount to the total power. This implies that if random noise were to be measured with an analyzer having an infinitesimal bandwidth, the noise reading would be zero at all frequencies. Going to the other extreme, a signal having an infinite number of components would have an infinite bandwidth and, therefore, infinite power. Since all physical systems have finite bandwidths, these two extremes are never encountered. However, the theory does reveal something about the nature of noise and permits one to conclude that it is possible to measure a finite quantity of random noise that is directly proportional to the measurement bandwidth.

In physics, the term "density" is used to describe quantity per unit volume, unit area or unit length. In exactly the same way, the term is applied to noise theory to describe the quantity of noise (i.e. power) per unit of bandwidth.

We know that we cannot truly measure the noise power at a specific frequency; but we can, using a narrow band spectrum analyzer, measure the average value of the total noise power quantized within its bandwidth. If we choose a Resolution Bandwidth setting that is narrow enough to resolve a flat portion of the noise power spectrum, we can safely assume that the average noise power (in watts) is directly proportional to the analyzer's noise power bandwidth.* We can, therefore, divide the total noise power by the analyzer's noise power bandwidth to determine the noise *density* per unit of bandwidth. By repeating this measurement at various points throughout the spectrum of interest, we can plot the noise power density as a function of frequency to graphically show the *power density spectrum*.

*The analyzer's noise power bandwidth is the ideal rectangular filter bandwidth having the same power response as the actual gaussian-shaped filter. In the 3585 , this is approximately 1.2 times the true 3 dB bandwidth established by the Resolution Bandwidth setting.

Requirements For Use

To properly use the NOISE LVL function, the following conditions must exist:

- a. The  function must be activated.
- b. The DISPL LINE function must be *deactivated*.
- c. The VIEW A Trace function must be activated, and the A-B function must be *deactivated*.
(Noise measurements can be performed *only* on the "A" Trace.)
- d. The instrument must either be sweeping or be in the Manual mode.
(Noise readings cannot be obtained after a single sweep has terminated.)
- e. The noise being measured must be *random* noise.
- f. The Resolution Bandwidth must be narrow enough to resolve a relatively flat portion of the noise spectrum.
- g. The external noise being measured must be equal to or greater than the analyzer's internal noise.

(A practical limit of sensitivity is about 10 dB above the analyzer's noise level.)

The 3585 Noise Readout

The 3585 NOISE LVL function provides a direct reading of the rms random noise spectral density (at the Marker), normalized to a 1 Hz bandwidth. Absolute noise level readings are displayed in the same units as the Reference Level; i.e., dBm, dBV or rms volts. Readings in "dBm (1 Hz)" indicate the noise power density in dB relative to one milliwatt across the 50-ohm or 75-ohm terminating impedance. Readings in "dBV (1 Hz)" indicate the random noise magnitude in dB relative to one volt rms i.e., 1V rms = 0 dBV (1 Hz). Readings in "volts $\sqrt{\text{Hz}}$ " simply indicate the rms noise voltage in a 1 Hz bandwidth.

Relative (Offset) noise-level readings are always displayed in "dB (1 Hz)" relative to the amplitude in the Offset Register.

Random noise power (in watts) is equal to the voltage squared divided by the resistance. When working with arbitrary impedances, however, it is common practice to assume a resistance of one ohm and use voltage squared as the unit of power. Random noise spectral density is usually specified in terms of power or voltage squared per unit of bandwidth. Readings in "dBV" (and dBm) are proportional to voltage squared and can, therefore, be correctly expressed as "dBV per hertz" and written "dBV/1 Hz" or, as on the 3585 readout, "dBV (1 Hz)". In practice, it is also common to work with the rms noise voltage. Given the noise power density in V^2/Hz , we can take the square root of the quantity to obtain "volts per root Hz" which is commonly written " $\text{V } \sqrt{\text{Hz}}$ ". This again is simply a way of expressing the quantity of random noise voltage in a 1 Hz bandwidth.

How Noise Readings Are Calculated

To calculate a random noise spectral density reading, the 3585 first takes one hundred independent, real-time amplitude readings at the Marker frequency. It then computes the average of the one hundred readings, adds correction factors to compensate for the response of the instrument's average-responding detector and log converter, and finally normalizes the result to a 1 Hz noise power bandwidth.

Noise Measurement Time

To obtain one hundred statistically independent amplitude readings, the instrument must allow adequate settling time between each reading. Settling time is determined primarily by the Resolution Bandwidth setting.* Narrowing the Resolution Bandwidth increases the instrument's response time and, therefore, increases the time required to obtain a noise reading. Approximate noise measurement times are as follows:

Resolution Bandwidth	Noise Measurement Time
30kHz	0.3 sec.
10kHz	0.3 sec.
3kHz	0.3 sec.
1kHz	0.3 sec.
300Hz	0.3 sec.
100Hz	1.1 sec.
30Hz	3.3 sec.
10Hz	11 sec.
3Hz	33 sec.

*The time between samples must be equal to or greater than the reciprocal of the equivalent bandwidth established by the RBW and VBW settings. During a noise measurement, the 3585 internally selects the 100 Hz VBW; so the measurement time is unaffected by the VBW that is selected by the operator.

Noise Measurement Accuracy

A noise reading is a *statistical estimate* of the random noise spectral density, based on the average of one hundred independent samples. A precise measurement of the true random noise density would theoretically require an infinite number of samples and thus, an infinite averaging period. Fortunately, however, the average of a reasonable number of samples yields results that are sufficiently accurate for practical purposes. Statistical theory indicates that the confidence level in an average is proportional to the square root of the number of samples. Thus, the average of one hundred samples is ten times better than a single sample.

The result obtained with a finite number of samples differs from the true value and the error itself is a random variable. For this reason, we cannot specify an exact amount of error; but we can, knowing its probability distribution, determine the probability of it being within certain limits. Based on the normal gaussian probability distribution, we can state (with 95% confidence) that the *composite* noise measurement accuracy is equal to the specified Marker amplitude accuracy ± 1.3 dB. It is important to note that the *composite* noise level includes both the external noise to be measured and the analyzer's own internal noise.

Noise Measurement Techniques

Noise level measurements can be performed three ways:

- a. With the instrument sweeping and the Marker set to the point of interest on the noise floor.
- b. In the Manual mode with the Marker at the Manual measurement point on the CRT trace.
- c. In the Manual mode with the Marker independently tuned away from the Manual frequency.

Instrument Sweeping

When the instrument is sweeping, a noise reading is calculated each time the frequency sweep passes through the Marker frequency. When the sweep reaches the Marker frequency, the sweep stops for a period of 0.3 seconds to 33 seconds while the *real-time* noise reading is calculated. During this period, the *suffix* of the amplitude or noise reading currently appearing in the top-right corner of the CRT screen is displayed brighter than normal to indicate that a noise reading is being taken. (The SWEEPING light, located in the Sweep control block, goes out to indicate that the sweep has been interrupted.) At the end of the noise calculation, the sweep resumes, the initial or updated noise level reading appears on the readout and the suffix returns to normal brightness to indicate that a valid noise reading is available.

NOTES

1. *The 3585 automatically calibrates at two-minute intervals, but the Auto.Cal. will not interrupt a noise calculation. If an Auto. Cal. cycle is initiated during a noise calculation, the calibration is held-off until the calculation is complete.*
2. *Changing the Marker frequency or any of the frequency or amplitude parameters will abort the noise calculation (if any) currently in progress. If the change in parameters initiates an Automatic Calibration, the new noise calculation does not begin until the end of the calibration cycle.*

Signal Tracking

Signal tracking is an on/off feature in the Marker/Continuous Entry section that can be activated during continuous sweeps to find a peak near the marker position, move it to the center of the display, and adjust the analyzer's center frequency to keep the peak at the center of the display. This "search and center" process occurs after every sweep while tracking is active. If the peak changes frequency between sweeps, the tracking feature changes the analyzer's center frequency to the new frequency of the peak (provided it hasn't moved to a frequency outside the selected sweep range since the end of the last sweep).

NOTE

If the signal tracking feature changes the analyzer center frequency (i.e., the signal peak is moving), the trace data is not valid until the next sweep is complete. The marker dot moves to the center of the screen immediately (where the peak being tracked will appear) and a new sweep begins. If the signal peak doesn't change frequency during the sweep, the peak will appear at the center of the display.

The signal-track algorithm works by selecting the nearest peak to the current marker position. The display line may be used to prevent the signal-track algorithm from tracking on noise or small spurs. If no peaks are found, no action is taken.

The ability to track a signal is dependent on the analyzer's sweep time versus the rate of frequency change of the tracked peak. Since the search for a peak occurs only between sweeps, it is possible for the signal peak to move out of the sweep range (frequency span) during a sweep. If this occurs, the search between sweeps may not find the same peak it had been tracking. Smaller sweep times and larger frequency spans improve the ability to track moving signal peaks. Also, if the marker is moved beyond the boundaries with the knob during a sweep, another peak may be selected to track.

NOTE

While signal tracking is active, changes in center frequency do not cause recalibration. The periodic calibration still occurs every two minutes.

Peak Search

Peak Search

The peak search function (in the Marker/Continuous Entry front-panel section) moves the marker to the point on the trace representing the largest amplitude. If the marker is not activated, pressing Peak Search activates the knob to control the marker. If several points have the same peak value, the marker is moved to the lowest frequency which has that value.

Definition of Peak. This definition applies to Next Peak, Next Left, and Next Right functions and the Signal Track function. A point on the trace is defined as a peak if it meets the following criteria:

1. The amplitude of the peak is greater than or equal to the display line (if the display line is on).
2. The amplitude of the point left of the peak (lower frequency) is less than or equal to that of the peak.
3. The amplitude of the point right of the peak (higher frequency) is less than that of the peak.
4. There is a point to the left of the peak with a value at least one division less than the peak with no intervening bin containing a larger value.
5. There is a point to the right of the peak with a value at least one division less than the peak with no intervening bin containing a larger value.

Next Peak. This function moves the marker to the peak with next-largest value, relative to the current marker position and activates the knob to move the marker. Peaks with amplitudes equal to and to the left of the current marker position are ignored. If one or more peaks of equal amplitude exist to the right of the current position, the marker is moved to the one nearest the current position. If there is no peak that satisfies the next-peak criteria, the analyzer beeps when the key is pressed (if the beeper is active) and the marker is not moved.

Next Left. This function moves the marker to the next peak left of (lower frequency relative to) the current marker position. If the marker is on the right skirt of a peak, next-left moves the marker to that peak if there is a value *between* the marker position and the peak that is at least one division below the value at the peak. The value at the present marker position is not considered in the definition of peak.

If a new peak is found, the knob is activated to move the marker. If there is no peak that satisfies the next-left criteria, the analyzer beeps when the key is pressed (if the beeper is active) and the marker is not moved.

Next Right. This function moves the marker to the next peak right of (higher frequency relative to) the current marker position. If the marker is on the left skirt of a peak, next-right moves the marker to that peak if there is a value *between* the marker position and the peak that is at least one division below the value at the peak. The value at the present marker position is not considered in the definition of peak.

If a new peak is found, the knob is activated to move the marker. If there is no peak that satisfies the next-right criteria, the analyzer beeps when the key is pressed (if the beeper is active) and the marker is not moved.

Noise Measurement Capabilities

It is important to note that the 3585 NOISE LVL function is intended only for measuring *random* noise. It cannot be used to accurately measure impulse noise or other signals containing discrete, phase-coherent frequency components. The main types of random noise that can be measured with the NOISE LVL function are:

a. Thermal Noise ("Johnson" or "white" noise):

Generated by thermally-excited random movement of electrons in a conductor. Characterized by uniform distribution of energy over the spectrum, and a gaussian distribution of levels. Present in virtually every electrical system (at temperatures above absolute zero) and is the most common type of noise that is measured.

b. Shot ("pink") Noise:

A noise mechanism caused by random current pulsations in tubes, transistors and diodes. It is actually a form of white noise, having constant power per Hertz of bandwidth.

c. Low Frequency (1/f) Noise:

Surface noise observed in tubes, transistors, diodes and various resistive elements, theoretically having infinite power at 0 Hz. Typically exhibits 3 dB per octave roll-off.

d. Phase Noise and Residual A.M.:

Phase noise (random phase modulation or "phase jitter") and residual A.M. ("amplitude jitter") measurements are commonly used to characterize the stability of oscillators and frequency synthesizers. Phase noise is a primary concern in the design of transmitting and receiving systems, particularly those used in guidance and detection applications. It is also a major concern in spectrum-analyzer design because it creates noise sidebands which degrade sensitivity.

e. Channel Noise:

This is a telecommunications term used to describe the composite background noise in a communications channel. It includes thermal noise, intermodulation noise (from multiplex pilot tones) and, in some cases, random cross-talk.

Further information concerning random noise measurements can be found in -hp- Application Notes 150-4 and 207. These application notes can be ordered from the nearest -hp- Sales Office.

Bandwidth Considerations

Noise level measurements can generally be performed using any convenient Resolution Bandwidth setting. No matter which RBW setting is used, the noise level reading is normalized to a 1 Hz bandwidth. There are, however, two important things to consider when selecting a RBW setting for noise measurements:

- a. Discrete signals (including spurious components and zero response) that are in the analyzer's passband during a noise level measurement can cause significant errors to appear in the noise reading. The RBW setting must, therefore, be narrow enough to resolve only the noise and reject any discrete components about the noise measurement frequency.

Before making noise-level measurements in a congested region, it is good practice to narrow the Frequency Span and Resolution Bandwidth to verify that there are no hidden discrete components near the noise measurement frequency. An elevated point on the trace can be checked to determine whether it is discrete or random by narrowing the RBW. The amplitude of a discrete component will remain essentially constant when the RBW is narrowed; but the noise amplitude on the CRT trace will decrease. This test must be performed with the instrument sweeping, or else in the Manual mode with the suspected component in the center of the passband.

- b. The amplitude of the noise signal must be reasonably flat within the analyzer's passband. When measuring low-frequency noise or phase noise where the noise amplitude rolls off, it is important to use a RBW that is narrow enough to resolve a flat portion of the noise curve.

Video Bandwidth

The 3585 internally selects the 100 Hz VBW setting during its noise measurement routine. (This does not appear on the VBW readout.) For this reason, the VBW that is selected by the operator does not affect the noise averaging process or the measurement time.

EFFECTS OF RESOLUTION BANDWIDTH ON NOISE MEASUREMENT SENSITIVITY:

Since random noise power is directly proportional to the measurement bandwidth, narrowing the Resolution Bandwidth by a factor of ten would theoretically reduce the internal noise level by a factor of ten or 10 dB. As a result, the internal random noise spectral density would be the same for all RBW settings and the noise measurement sensitivity would be unaffected.

Due to noise mechanisms in the instrument's IF section, however, the internal noise level does not always decrease in direct proportion to the Resolution Bandwidth. For this reason, there are cases where narrowing the Resolution Bandwidth increases the internal noise spectral density and, consequently, decreases the noise measurement sensitivity. This effect is particularly noticeable when switching from the 1 kHz RBW to the 300 Hz RBW.

The following table lists the *typical* internal noise spectral density for each RBW setting *relative* to the 30 kHz RBW. This information can be used as an aid in selecting a Resolution Bandwidth that will provide the best compromise between sensitivity and resolution for your particular measurement.

RBW	Internal Noise Density (Relative to 30 kHz RBW)
30 kHz	0 dB (1 Hz)
10 kHz	+0.2 dB (1 Hz)
3 kHz	+0.8 dB (1 Hz)
1 kHz	+0.8 dB (1 Hz)
300 Hz	+4.0 dB (1 Hz)
100 Hz	+2.0 dB (1 Hz)
30 Hz	+1.0 dB (1 Hz)
10 Hz	+1.0 dB (1 Hz)
3 Hz	+1.0 dB (1 Hz)

Noise Measurement Sensitivity

The lower limit of sensitivity for noise-level measurements is determined by the analyzer's own internally generated noise. During a noise calculation, the 3585 samples the composite noise signal within its passband, which includes its own internal noise as well as the external noise that the operator is interested in measuring. The total noise power in the analyzer's passband is the sum of the powers of the individual noise signals. Thus, if the external noise power is equal to the internal noise power, the total noise power (and the noise-level reading) will be 3 dB above the internal noise level. For practical purposes, an external noise signal that produces a 3 dB increase in the noise-level reading is considered to be the minimum discernable signal.

In the measurement of a minimum-discernable signal, the error contributed by the analyzer's internal noise is about 3 dB. Since this amount of error is unacceptable for most applications, it is necessary to either increase the limit of sensitivity or measure the analyzer's internal noise and subtract it from the noise-level reading.

In keeping with the accuracy requirements for most noise measurement applications, a reasonable limit of sensitivity is 10 dB above the analyzer's internal noise level. When the external noise is 10 dB above the internal noise, the error contributed by the internal noise is about 0.41 dB. From that point, the error (in dB) is inversely proportional to the external noise power. Thus, if the external noise is increased to 20 dB above the internal noise (a factor of ten), the error is reduced to 0.04 dB.

Internal Noise Measurement

The analyzer's internal noise spectrum consists of broadband thermal noise, shot noise, low-frequency ($1/f$) noise and phase noise. With the exception of phase noise, the internal noise spectral density can be measured (with no input signal) and subtracted from the composite noise-level reading using the procedure given in Figure C. Internal phase noise, which appears only in the presence of a large input-signal response, is difficult to measure and must, therefore, be treated separately.

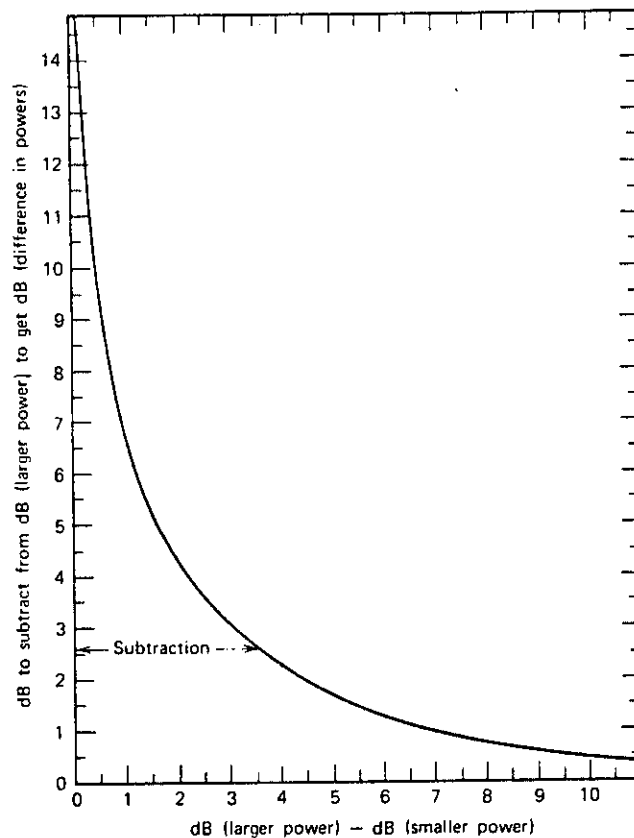

- a. Using the NOISE LVL function, measure the composite (external and internal) noise and record the reading in dBm (1 Hz) or dBV (1 Hz).
- b. With the composite noise reading still on screen, activate the OFFSET function and press the ENTER OFFSET key.
- c. Deactivate the AUTO RANGE function. Disconnect the input signal.
- d. With the NOISE LVL and OFFSET functions still activated, note the "OFFSET" noise-level reading.

(This is simply the "dB difference" between the composite noise level and the internal noise level.)

- e. Spot the "OFFSET" noise-level reading on the horizontal axis of the graph shown above. Project upward to intersect the curve, and from that point, project horizontally to locate the "dB to be subtracted" on the vertical axis. Subtract that value from the composite noise-level reading recorded in Step a.

Figure C. Subtracting the Analyzer's Internal Noise

Internal Phase Noise

As a general rule, the 3585's internal phase noise does not need to be considered unless you are measuring the phase noise of an external source or are otherwise measuring low-level noise near the skirt of a large response. As shown in Figure D, the internal phase-noise sidebands form a pedestal which extends approximately 150 kHz on each side of the signal (i.e., "carrier") frequency. The amplitude of the phase-noise pedestal (and the phase-noise spectral density) is proportional to the carrier amplitude. When the peak of the carrier's response is less than 80 dB above the broadband noise floor, the phase-noise pedestal is well below the broadband noise and cannot be seen or measured.

The phase noise *spectral density* is unaffected by the Resolution Bandwidth setting. However, as the Resolution Bandwidth is increased, the filter skirts become wider and, therefore, cover a wider portion of the phase-noise spectrum. With the Resolution Bandwidth set to 30 kHz, the entire phase-noise pedestal is masked by the filter skirts. When the RBW is set to 10 kHz, the worst-case phase noise, appearing at approximately ± 35 kHz away from the carrier, is typically more than 118 dB (1 Hz) below the peak of the carrier. When the RBW is 3 kHz or narrower, the phase noise is typically more than 115 dB (1 Hz) below the peak of the carrier at frequencies ± 15 times the RBW away from the carrier.

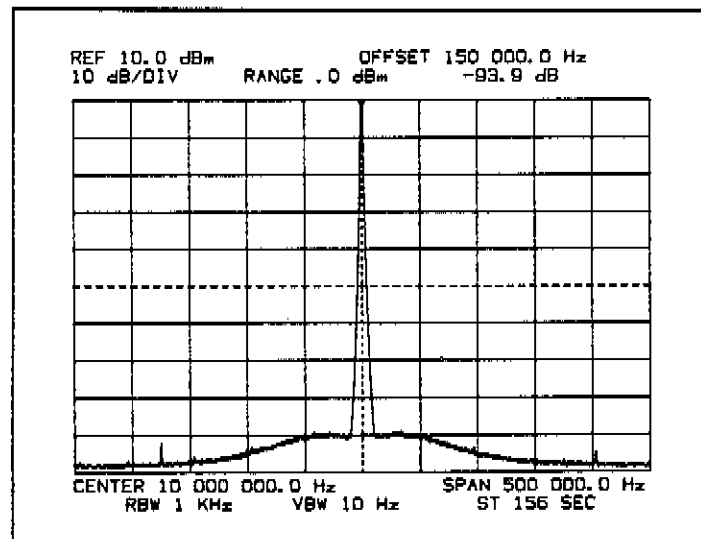

Figure D. Internal Phase-Noise Pedestal

CHAPTER 9 REMOTE OPERATION

INTRODUCTION TO HP-IB OPERATION

The 3585 Spectrum Analyzer is remotely controlled via the Hewlett-Packard Interface Bus (HP-IB). The following information gives a general description of the HP-IB and defines the terms, concepts, and messages used in an HP-IB system. It also lists the capabilities and requirements for programming the 3585. Program examples using a specific Hewlett-Packard computer as the system controller may be found in the Supplemental Programming Information, Appendix 3-A at the end of this section.

NOTE

The HP-IB is Hewlett-Packard Company's implementation of IEEE Standard 488-1978, "Standard Digital Interface for Programmable Instrumentation."

General HP-IB Description

The HP-IB is a parallel bus of 16 active signal lines grouped into three sets according to function, to interconnect up to 15 devices. Figure 3-9-1 is a diagram of interface connections and bus structure. A complete description of the HP-IB lines, commands, internal operation, etc., may be found in the HP-IB Abbreviated Description, HP Part No. 5955-2903. A copy may be obtained through any HP Sales and Service Office.

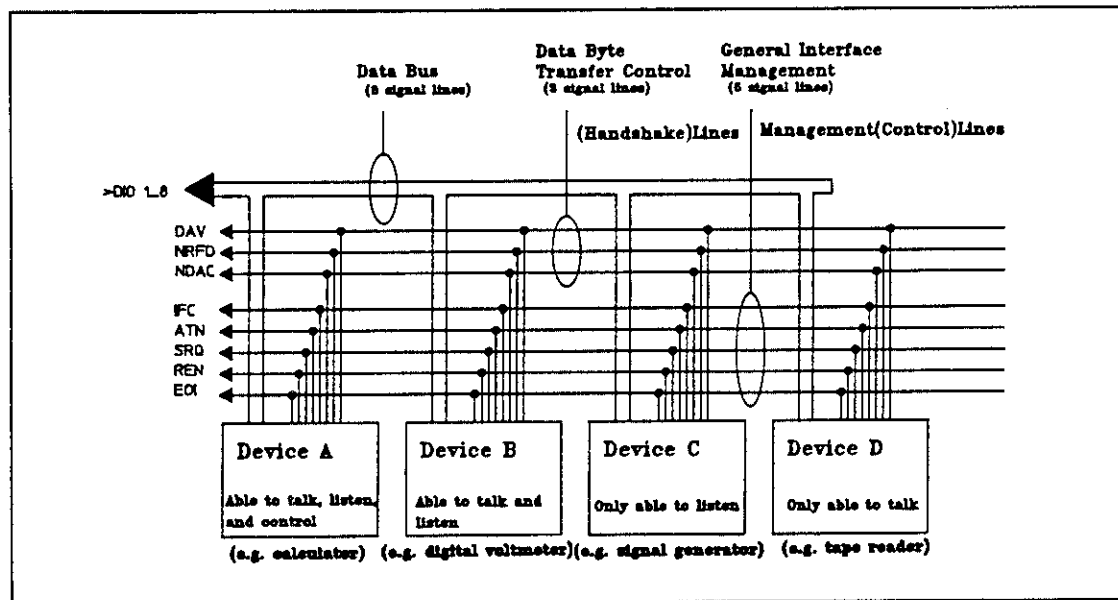

Figure 3-9-1. Interface Connections and Bus Structure.

Remote Operation

Eight signal lines form the first set and are called "data" lines. The data lines carry coded messages which represent addresses, program data, measurements, and status bytes. The same data lines are used for input and output messages in bit-parallel, byte-serial form. Normally, a seven-bit ASCII code represents each piece (byte) of data, leaving the eighth bit available for parity checking.

Data transfer is controlled by means of an interlocked "handshake" technique which permits data transfer (asynchronously) at the rate of the slowest device participating in that particular conversation. The three data byte transfer control lines which implement the handshake form the second set of lines.

The remaining five general interface management lines form the third set, and are used in such ways as activating all the connected devices at once, clearing the interface, etc. Table 3-9-1 defines each of the management lines.

Table 3-9-1. General Interface Management Lines.

Name	Mnemonic	Description
Attention	ATN	Enables a device to interpret data on the bus as a controller command (command mode) or data transfer (data mode).
Interface Clear	IFC	Initializes the HP-IB system to an idle state (no activity on the bus).
Service Request	SRQ	Alerts the controller to a need for communication.
Remote Enable	REN	Places instruments under remote program control.
End or Identify	EOI	Indicates last data transmission during a data transfer sequence; used with ATN to poll devices for their status.

Definition of HP-IB Terms and Concepts.

Byte – A unit of information consisting of eight binary digits (bits).

Device – Any unit that is compatible with the IEEE Standard 488-1975.

Device-Dependent – (1) An action a device performs in response to information sent on the HP-IB. The action is characteristic of an individual device and may vary from device to device. (2) The data required to communicate with a particular device.

Operator – The person that operates either the system or any device in the system.

Address – The characters sent by a controller to specify which device will receive information. A device may also have its address fixed so that it may only receive information (listen only) or only send information (talk only).

Polling – Polling is a means by which a controller can identify a device that needs interaction with it. The controller may poll devices for their operational condition one at a time, which is termed a serial poll, or as groups of devices simultaneously, which is termed a parallel poll.

Basic Device Communication Capability.

Devices which communicate along the interface bus fall into three basic categories.

Talkers—Devices which send information on the buss when they have been addressed.

Listeners—Devices which receive information sent on the bus when they have been addressed.

Controllers—Devices that can specify the talker and listener(s) for an information transfer. The controller can be an active controller or a system controller. The active controller is defined as the current controlling device on the bus. The system controller can take control of the bus even if it is not the active controller. Each system can have only one system controller even if several controllers have system control capability.

Message Definitions.

Information is transferred on the HP-IB from one device to one or more other devices in quantities called "messages." Some of the messages consist of two basic parts, the address portion and the information portion. Others are general messages to all devices. Messages can be classified in twelve types, referred to as "bus messages." These are defined in Table 3-9-2. A block diagram presentation of bus messages and their implementation is in Appendix 3-B at the end of this section.

Analyzer Response to Messages.

The analyzer is capable of implementing only those messages indicated in Table 3-9-3. In order for those messages to be implemented, certain bus actions are required, which are shown in the Interface Functions column.

HP-IB Work Sheet.

A work sheet is provided at the end of Appendix 3-B for listing the address and message capabilities of each instrument in your HP-IB system. When this sheet is filled out, it provides a summary of the system capabilities.

HP-IB Addressing.

Certain messages require that a specific talker and listener be designated. Each instrument on the bus has its own distinctive listen and/or talk address which distinguishes it from other devices. The analyzer receives programming instructions or binary information when addressed to listen. When addressed to talk, it will respond to the instructions it received prior to being addressed to talk, such as output mode or serial poll.

Addressing usually takes the form of "universal unlisten, device talk, device(s) listen." The universal unlisten command removes all listeners from the bus, allowing only the listener(s) designated by the device(s) listen parameter to receive information. The information is sent by the talker designated by the device talk parameter. The system controller may designate itself as either talker or listener.

Remote Operation

Table 3-9-2. Definitions of Bus Messages.

Message	Definition
DATA	The actual information (binary bytes) which is sent from a talker to one or more listeners. The information or data can be in a numeric form or a string of characters.
TRIGGER	The trigger message causes the listening device(s) to perform a device-dependent action.
CLEAR	A clear message will cause a device(s) to return to a pre-defined device-dependent state.
REMOTE	The remote message causes the listening device(s) to switch from local front panel control, to remote program control. This message remains in effect so that devices subsequently addressed to listen will go into remote operation.
LOCAL	This message clears the remote message from the listening device(s) and returns the device(s) to local front panel control.
LOCAL LOCKOUT	This message causes all devices to be removed from the local lockout mode and revert to local. It will also clear the remote
CLEAR LOCKOUT AND SET LOCAL	This message causes all devices to be removed from the local lockout mode and revert to local. It will also clear the remote message for all devices.
REQUIRE SERVICE	A device can send this message at any time to signify that it needs some type of interaction with the controller. The message is cleared by the device's status byte message if it no longer requires service.
STATUS BYTE	A byte that represents the status of a single device. One bit indicates whether the device sent the required service message and the remaining 7 bits indicate operational conditions defined by the device. This byte is sent from the talking device in response to a "Serial Poll" operation performed by a controller.
STATUS BIT	A byte that represents the operational conditions of a group of devices on the bus. Each device responds on a particular bit of the byte thus identifying a device-dependent condition. This bit is typically sent by devices in response to a parallel poll operation. The status bit message can also be used by a controller to specify the particular bit and logic level that a device will respond with when a parallel poll operation is performed. Thus more than one device may respond on the same bit.
PASS CONTROL	This message transfers the bus management responsibilities from the active controller to another controller.
ABORT	The system controller sends the abort message to unconditionally assume control of the bus from the active controller. The message will terminate all bus communications but does not implement the clear message.

Setting the HP-IB Address

The HP-IB address is set by pressing the Bus Address key (blue-Local) and making a numeric entry between 0 and 30. When Bus Address is activated, it displays the current value near the lower-left corner of the screen with the line intensified to indicate entry is active.

If two numeric keys are pressed, the new value appears in the display message as it is entered and the characters dim when the second key is pressed, indicating the entry is complete. If the new address is a single digit (in the range of 0-9) you can either enter a leading 0 (zero), thus using two digits to complete the entry, or enter the single digit followed by any nondigit key (except the arrow keys and Instrument Preset). When the non-digit key is pressed, the new bus address is entered and the function of the key is implemented.

Table 3-9-3. Implementation of Bus Messages.

Message	Implementation*	Interface Functions**		3585 Response
		Sender	Receiver	
Data	SR	T, SH	L ⁿ , AH	Will send or receive as instructed.
Trigger	R	T, SH	L ⁿ , AH	Rearms sweep. Will start next sweep when next trigger (Free Run, Line or Ext) occurs.
Clear	R	C, SH C, SH	DC ⁿ , L, AH DC ⁿ , AH	Device Clear sets 3585A to initial turn-on conditions. See Para. 2-26.
Remote	R	C _s SH ⁿ	RL ⁿ , L, AH RL ⁿ , AH	Goes to Remote. Can be set to Local by LOCAL key.
Local	R	C, SH	RL ⁿ , L, AH	Goes to Local.
Local Lockout	R	C, SH	RL ⁿ , AH	Goes to Remote. Cannot be set to Local by LOCAL key.
Clear Lockout and Set Local	R	C _s	RL ⁿ	Goes to Local from Local Lockout.
Require Service	S	SR ⁿ	C	Sets SRQ True.
Status Byte	S	SR, T, SH	L ⁿ , AH	Sends byte which indicates if service required and reason.
Status Bit	NA	PP ⁿ	C	None
Pass Control	NA	C _A , SH	C _B , T, AH	None
Abort	R	C _s		Unaddress

*S = Send Only
R = Receive Only
SR = Send and Receive
NA = Not Applicable

**SH = Source Handshake
AH = Acceptor Handshake
T = Talker (includes TE = Extended Talker)
L = Listener (includes LE = Extended Listener)
SR = Service Request
RL = Remote/Local
PP = Parallel Poll
DC = Device Clear
DT = Device Trigger
C = Any Controller
C_N = A specific controller (for example, C_A, C_B)
C_s = The System Controller
Xⁿ = Indicates message can be sent by/to one or more devices simultaneously.

If the up-arrow (increment) or down-arrow (decrement) keys are pressed, the displayed address is incremented or decremented accordingly. The new value is entered by pressing any non-digit key except the arrow keys and the Instrument Preset key.

Other bus address considerations:

- If the new bus address entry is greater than 30, an out-of-range error message is displayed.
- Pressing Instrument Preset or cycling power does not change the bus address .
- The bus address is set to 0 by a memory clear (see "Green Key" in Chapter 1).

Remote Operation

Analyzer HP-IB Capabilities.

Table 3-9-4 lists the HP-IB capabilities of the analyzer which are compatible with IEEE Standard 488-1978.

Table 3-9-4. Interface Capabilities.

Code	Function
SH1	Source handshake capability
AH1	Acceptor handshake capability
T5	Basic talker; Serial Poll; Unaddressed to talk if addressed to listen; talk-only
L4	Basic listener; Unaddressed to listen if addressed to talk
SR1	Service request capability
RL1	Remote/Local capability
PP0	No Parallel poll capability
DC1	Device clear capability
DT1	Device trigger capability
CO	No controller capability
E1	Open collector outputs

Developing an HP-IB Program.

Basically, the analyzer is programmed remotely in the same manner as it is programmed from the front panel. The following exceptions apply:

- There is no code for the Instrument Preset key. The same thing may be accomplished in remote control with a Device Clear command.
- Key codes which cause an internal calibration as a part of the key code processing.

The order in which key code programming occurs is just as important as when entering key codes from the front panel. Hints on how to program the analyzer for maximum execution speed may be found in *Programming for Maximum Speed* later in this chapter. Other important factors to keep in mind when operating the analyzer remotely are:

- ASCII characters for space, plus, comma, and carriage return are ignored.
- The ASCII character for line feed terminates the entry of a string of key codes.
- The SRQ line is set when an input code is received that is not understood. When a serial poll of the instrument is made, Status Byte bit 0 is set to 1.
- A device trigger rearms the sweep in either single or continuous sweep mode.
- The analyzer does not read data from or write data to the bus while it is calibrating.

NOTE

The 3585 buffers one character of the command string while it processes commands. If you want to issue the Device Clear command, be sure to include at least one character between the last character of the last command to be executed and the clear command. This character is usually a space or a line feed.

Several steps are needed to develop an HP-IB program.

1. Completely define the operation(s) the system is required to perform.
2. Write the program in flow chart or algorithm form. (An algorithm may be defined as a fixed step-by-step procedure for finding a solution to a problem.) Use the key words for bus messages shown in Table 3-9-2 in developing the program.

NOTE

The bus message in itself is not a program code or an HP-IB command. It is only intended as a tool to translate a program written as an algorithm into the controller's code.

3. Define the operation in instrument-specific program codes. Each instrument has its own set of program codes which are ASCII characters. The 3585 program codes are shown in Table 3-9-9.
4. Convert the program into the controller's language. The conversion information is supplied with each controller.

NOTE

Examples for controlling the analyzer with a specific Hewlett-Packard calculator are provided in the Supplemental Programming Information, Appendix 3-A at the end of this section.

Block diagrams and explanations of the bus messages for the 3585 are shown in Appendix 3-B at the end of this section.

Remote Operation

Universal and Addressed Commands.

The analyzer responds to the following commands sent in the command mode (ATN true).

Table 3-9-5. Universal and Addressed Commands.

Universal Commands

Mnemonic	Command	ASCII Code
DCL	Device Clear	DC4
LLO	Local Lockout	DC1
MLA	My Listen Address	(selectable)
MTA	My Talk Address	(selectable)
SPD	Serial Poll Disable	EM
SPE	Serial Poll Enable	CAN
UNL	Unlisten	?
UNT	Untalk	--

Addressed Commands

GTL	Go To Local	SOH
SDC	Selected Device Clear	EOT
GET	Group Execute Trigger	BS

Placing The Analyzer In Remote.

The analyzer goes into remote mode when ATN is true, REN is true, and it receives its listen address. The analyzer address is normally set at the factory to 11.

NOTES

1. All programming is shown in ASCII code.
2. Table 3-9-9 is a summary of the analyzer program data messages .
3. The analyzer must be set to REMOTE and addressed to LISTEN before it accepts device-dependent data messages.
4. When the analyzer is addressed to listen while in local, it handshakes the data message and then ignores the data.

Settling Time.

Table 3-9-6 shows the settling time-delay that occurs after a frequency change. This allows the analog circuitry to settle enough to meet the performance specifications. The times shown do not include any auto-calibration time which might be present.

Table 3-9-6. Settling Times.

RBW (Hz)	VBW<3RBW	VBW=RBW	VBW (Hz)	VBW=1/3RBW	VBW<1/3RBW
—	—	—	1	1.53 sec	1.34 sec
3	.692 sec	.796 sec	3	.525	.463
10	.225	.256	10	.175	.157
30	91.7 msec	.102	30	75.3 msec	69.0 msec
100	45.0	48.1 msec	100	40.2	38.3
300	31.7	32.7	300	30.3	29.7
1K	27.0	27.3	1K	26.7	26.5
3K	25.7	25.8	3K	25.8	25.7
10K	25.2	25.2	10K	25.0	—
30K	25.2	25.2	30K	—	—

Bus Debugging

The bus debug feature is designed to help troubleshoot problems with remote operation. When active, characters present received by the 3585 are displayed on the display so you can compare what you sent to what the analyzer received.

The feature is activated by sending BG1 to the analyzer or pressing the front-panel keys (blue) 3 (toggles the bus debug feature on and off). When activated, the message "Bus debug on:" appears near the top of the display. As the analyzer receives ASCII characters over the bus it adds them to this line, referred to as the "bus debug display line." While the analyzer is in remote mode and bus debug is active:

- ASCII character received by the analyzer is placed at the right end of the line; all other characters in the line are shifted left. Non-printable characters are represented with a tilde (~).
- Reception of binary data and bus commands is not indicated in the display.
- When a two-character mnemonic is received, the analyzer pauses for about .5 seconds.
- If a bus syntax error occurs (or any error that displays an error message), the beeper beeps (unless it is disabled), a ■ character is entered into the bus debug display line, and the analyzer pauses for about 10 seconds.

The bus debug feature is turned off with the BG0 command or by pressing (blue) 3 again. Also, the feature is disabled by an instrument preset or cycling the power, but a device clear (DCL) does not disable it.

Remote Operation

Analyzer Data Message Formats.

The remote commands fall into three message format categories as described in the following list. The column titled "Message Format" in Table 3-9-9 contains numbers referring to the formats listed here.

1. Mnemonic, Data, Delimiter
2. Mnemonic, Data
3. Mnemonic

A command string may contain more than one command. Each string should be terminated by an end-of-string (EOS) character. The valid EOS character is LF (line feed). All spaces, carriage returns, plus signs, and commas are ignored by the 3585.

Compatibility with the 3585A

The 3585B is designed to improve upon the design of, and yet be compatible with, the 3585A. This discussion addresses the topic of compatibility.

There are, obviously, new front-panel features such as peak searching, signal tracking, limit testing, and digital plotting. A blue shift key has been added to increase the number of front-panel features without adding a like number of keys. There are more keys on the front panel and some existing functions have been moved to new locations on the 3585B. There are more registers to store instrument states and trace data (10 each) and they are nonvolatile.

Compatibility issues are more of a concern with remote operation. First of all, none of the "old" commands have been deleted. Some redundant commands have been added to correspond to the new access method of an existing feature. For example, you can turn off the beeper with the old 3585A SV5 command or, now that it is a shifted function, use BE0.

Generally, command execution times have changed. Most commands execute faster in the 3585B than they did in the 3585A. Some execute a little slower, too. The execution time lost to running the A/D converter or having two traces displayed is less in the 3585B. Also, the 3585B asserts the EOI bus management line with the last byte of a transmission; the 3585A did not.

NOTE

If a program written for the 3585A depends on the execution speed of the remote operation commands to provide settling times, for example, the program may fail when executed for the 3585B.

3585-SPECIFIC HP-IB COMMAND DEFINITIONS

Introduction

The remote operation command set for the 3585 is broken into two categories: 1) commands matching front-panel keys and, 2) remote-only commands. The definitions of the front-panel keys exist in earlier chapters and no additional information about them exists here, except that their mnemonics and message format are listed in Table 3-9-9a, divided into sections analogous to front-panel key groups.

Remote-only commands either have no front-panel counterparts, are only useful when the analyzer is used in remote control, or are special commands for servicing the analyzer. They move data to or from registers in the 3585, activate special trigger types, allow special control of the display, or monitor operator key presses at the front panel. The entire command set recognized by the 3585 is listed in Table 3-9-9 (a and b).

Table 3-9-9b is the remote-only command set defined here.

Output Function Operating Conditions

1. Each dump type (D0–D9) and each trigger (T4, T5, and T6) is mutually exclusive (only one may be active at a time) and each is in effect until changed (there is no "off" command).
2. The output functions are not stored with the instrument state and are not part of the learn mode data.
3. The default conditions (after a power up or instrument preset) are D1 with no trigger.
4. The data dumped is the same as that displayed.
5. The amplitude data output format is 11 characters with leading zeros set to spaces.

$$\pm \text{XXXXX.XXE-X}$$

where X represents a digit and E–X indicates a power of ten; E–0 is used with values in dB.

6. The frequency data output format is 12 characters with leading zeros set to spaces.

$$\pm \text{XXXXXXXXXX.X}$$

and the output resolution is always in 0.1 Hz.

7. Each output must be preceded by a trigger, except for D8 and D9.

Remote Operation

Data Dump Modes

D0 – Dump extended status. Dumps three bytes of information:

1. Extended status information (see Table 3-9-7)
2. Error information; last error message displayed (see Table 3-9-8)
3. Calibration error number (see the service manual)

This information should not be confused with the Status Byte accessed via a serial poll. See the discussions on Serial Poll and Status Byte later in this chapter.

D1 – Dump marker amplitude. This is the default data dump mode. It occurs after instrument preset or when the instrument is turned on if the selected power-up state is instrument preset. (See the discussion on "Power-On Options" in Chapter 1.)

D2 – Dump marker amplitude and frequency. This is identical to D1 with the addition of the marker frequency.

D3 – Dump trace A. This command causes the 3585 to output Trace A information in the form of 1001 amplitude readings. It is the same as reading each of the 1001 points in Trace A with Noise Level off using the D1 command, with data points separated by commas.

D4 – Dump trace B. Same as D3 except that the information output is from Trace B.

D5 – Dump calibration data. The data output consists of the offset frequency and offset amplitude correction factors for each of the nine bandwidths (nine pairs of numbers). The first data output is the 3 Hz bandwidth pair. Frequency data is in 0.1 Hz resolution and the amplitude is in dB at 0.01 dB resolution.

D6 – Dump extended status sans calibration error byte. This command is the same as the D0 command without the third byte (calibration error number).

D7 – Dump display alphanumerics. The display alphanumerics are dumped on the bus in the following order:

1. Reference level
2. Marker frequency
3. Scale (dB/Div)
4. Range
5. Marker or display line amplitude
6. Start or center frequency
7. Stop or span frequency, or center-frequency step size
8. Resolution bandwidth
9. Video bandwidth
10. Sweep time

D8 – Performs the same function as D1 and then triggers another measurement; when the data is read from the analyzer an implied T4, T5, or T6 occurs (whichever is active).

D9 – Performs the same function as D2 and then triggers another measurement.

Table 3-9-7. Extended Status Information.

Bit	Value	Description
B0	1	Up Range. Set while an auto range is in progress or the overload light is on.
B1	2	Down range. Set while an auto range is in progress or the applied signal is not near full scale minus 5 dB.
B2	4	Trip. Input tripped (unterminated).
B3	8	Uncal. Sweep uncalibrated.
B4	16	Lock. L.O. unlocked.*
B5	32	Error. Error message has been displayed.*
B6	64	Cal Error. Internal calibration error on last calibration.*
B7	128	Sweep. Instrument is sweeping.

* Reset by instrument preset or device clear

Table 3-9-8. Messages in the Error Byte†.

Decimal Value	Error Message	Decimal Value	Error Message
1	Out of range	19	Calibration disabled
2	Ref < 100 dB below range	20	Instrument test mode XX
3	1, 3, 10 steps only	21	Counter failure
4	Too many digits	22	Beeper disabled
5	Entry mode undefined	23	Counter out of limit
6	Calibrating	24	Enter TST#? preset
7	Use step keys only	25	HP-IB flag line error
8	HP-IB remote set	26	Bad data in register
9	/Div = 1, 2, 5, 10 only	27	Inst Preset to abort
10	Ref > 10 dB over range	28	Controller on bus
11	Sweep span limited	29	Track gen offset ON
12	Sweep rate too small	30	Track gen offset OFF
13	HP-IB local lockout	31	Single loop mode ON
14	Sweep time in .2 sec steps	32	Single loop mode OFF
15	Enter register number	33	A-B ref at disp line
16	Register undefined	34	Aborting plot . . .
17	Calibration error XX	35	No listener on bus!
18	Local osc. unlocked	36	No marker to plot!

† Reset by instrument preset or device clear

Remote Operation

Dump Data Format

The data format of the dump commands are listed individually for each of the dump types in the following. All symbols shown are ASCII symbols unless otherwise noted, including the commas. The last character is sent with EOI asserted.

D0: <extended status byte><error byte><cal. error byte>

D1: <marker amplitude><CR><LF>

D2: <marker frequency>,<marker amplitude ><CR><LF>

D3: <marker amplitude, position 1>,
<marker amplitude, position 2>,
 .
 .
 .
<marker amplitude, position 1001><CR><LF>

D4: Same as D3.

D5: <cal. offset freq. 3 Hz BW>,<cal. offset amp. 3 Hz BW>,
<cal. offset freq. 10 Hz BW>,<cal. offset amp. 10 Hz BW>,
 .
 .
 .
<cal. offset freq. 30 kHz BW>,<cal. offset amp. 30 kHz BW><CR><LF>

D6: <extended status byte><error byte>

D7: **Notes:** Unused characters sent as spaces. "Preface" refers to leading characters displayed for each listing, such as "REF" for reference level. Number in parenthesis is number of characters sent in string.

Reference Level (14): <preface><number><suffix><CR><LF>
Top right frequency (25): <preface><number><suffix><CR><LF>
Scale (dB/Div) (9): <number><<suffix><CR><LF>
Range (15): <preface><number><suffix><CR><LF>
Marker amplitude (14): <number><suffix><CR><LF>
Start, center freq. (22): <preface><number><suffix><CR><LF>
Stop, span freq. (20): <preface><number><suffix><CR><LF>
Resolution bandwidth (11): <preface><number><suffix><CR><LF>
Video bandwidth (11): <preface><number><suffix><CR><LF>
Sweep time (12): <preface><number><suffix><CR><LF>

D8: <marker amplitude><CR><LF>

D9: <marker frequency>,<marker amplitude><CR><LF>

Table 3-9-9a. Front-Panel-Equivalent Commands.

Command	Mnemonic	Data Description	Suffixes	Message Format
Entry Section				
Center freq.	CF	1-9 digits and decimal pt., 0 to 40.1 MHz, UP or DN	HZ, KZ, MZ	1, 2
Freq. span	FS	1-9 digits and decimal pt., 0 to 40.1 MHz, UP or DN	HZ, KZ, MZ	1, 2
Start freq.	FA	1-9 digits and decimal pt., 0 to 40.1 MHz, UP or DN	HZ, KZ, MZ	1, 2
Stop freq.	FB	1-9 digits and decimal pt., 0 to 40.1 MHz, UP or DN	HZ, KZ, MZ	1, 2
CF step size	CS	1-9 digits and decimal pt., 0 to 40.1 MHz, UP or DN	HZ, KZ, MZ	1, 2
Ref. level	RL	1-3 digits and decimal pt., from 10 db above range to -100 dB below range, UP or DN	DM, DV	1, 2
dB/Div (scale)	DD	1, 2, 5, or 10; UP or DN	DB	1, 2
Ref. level (V)	RV	1-3 digits and decimal pt., from range $\times 3.14$ to range $\times 10^{-9}$, UP or DN	VL, MV, UV	1, 2
Full sweep	FL	No data		3
Bus debug	BG	0 (off)		2
	BG	1 (on)		2
Save trace A	TS	0-9		2
Recall trace A	TR	0-9		2
Power-up state	PO	0 (Same as Inst Preset)		2
	PO	1 (Save \rightarrow 0; power-up preset)		2
	PO	2 (Power-up in state 0)		2
	PO	3 (Save \rightarrow 0; power-up state 0)		2
Save state	SV	.1-9		2
Recall state	RC	.1-9		2
Autocalibration	AC	0 (off)		2
	AC	1 (on)		2
Beeper	BE	0 (off)		2
	BE	1 (on)		2
Autocalibration off	SV [†]	4		2
Autocalibration on	RC [†]	4		2
Beeper off	SV [†]	5		2
Beeper on	RC [†]	5		2
Increment	UP	No data, affects value of active parameter		3
Decrement	DN	No data, affects value of active parameter		3

[†] These codes, though redundant, are included to assure compatibility with existing 3585A programs.

Remote Operation

Table 3-9-9a. Front-Panel-Equivalent Commands (con't).

Command	Mnemonic	Data Description	Suffixes	Message Format
RBW-VBW-ST Section				
BW coupling	CP	0 (off)		3
	CP	1 (on)		3
Res. BW hold	BH	0 (off)		3
	BH	1 (on)		3
Preset	PR	No data		3
Res. BW	RB	3, 10, 30 . . . 30,000, UP or DN	HZ, KZ	1, 2
Video BW	VB	1, 3, 10, . . . 30,000, UP or DN	HZ, KZ	1, 2
Sweep time	ST	.2 to 999,999, UP or DN	SC	1, 2
Sweep Section				
Continuous	S1	No data		3
Single	S2	No data		3
Manual entry	S3	Any numeric entry from 0 to 40,100,000 that falls within the frequency span limits, UP or DN.	HZ, KZ, MZ	1, 2
Trace Section				
Clear A	CA	No data		3
View trace A	TA	0 (off)		3
	TA	1 (on)		3
View trace B	TB	0 (off)		3
	TB	1 (on)		3
Store A→B	SA	No data		3
Store B→A	SB	No data		3
Max hold	MH	0 (off)		3
	MH	1 (on)		3
A-B	AB	0 (off)		3
	AB	1 (on)		3
Trigger Section				
Free run	T1	No data		3
Line	T2	No data		3
Ext	T3	No data		3

Table 3-9-9a. Front-Panel-Equivalent Commands (con't).

Command	Mnemonic	Data Description	Suffixes	Message Format
Marker/Continuous Entry				
Marker position	MK	1-1001		2, 3
Marker	C1	IL or IR (Knob: incr. left or right)		3
Manual	C2	IL or IR		2, 3
Ref. level	C3	IL or IR		3
Center freq.	C4	IL or IR		3
Dsp. line	C5	IL or IR		3
Off	C6	No data		3
Clear dsp. line	CL	No data		3
Counter	CN	0 (off)		3
	CN	1 (on)		3
Noise level	NL	0 (off)		3
	NL	1 (on)		3
Offset	OF	0 (off)		3
	OF	1 (on)		3
Enter offset	MO	No data		3
Mkr→C freq.	MC	No data		3
Mkr→Ref. Ref Lvl	MR	No data		3
Mkr/Ofs→ Step	MS	No data		3
Offset→ Span	OS	No data		3
Peak search	SP	No data		3
Next peak	NP	No data		3
Next left	LP	No data		3
Next right	RP	No data		3
Signal track	TP	0 (off)		3
	TP	1 (on)		3
Disp. line pos.	DL	0-1023		2
Knob:				
increment left	IL	No data		3
increment right	IR	No data		3
Input Section				
Impedance:				
1 MΩ	I1	No data		3
50Ω	I2	No data		3
75Ω	I3	No data		3
Auto range	AR	0 (off)		3
	AR	1 (on)		3
Range	RA	UP or DN		2
	R	01 thru 12 (see "Range Control")		2
Ref. level track	AL	0 (off)		3
	AL	1 (on)		3

Remote Operation

Table 3-9-9a. Front-Panel-Equivalent Commands (con't).

Command	Mnemonic	Data Description	Suffixes	Message Format
Plot Commands				
Default settings	PD	No data		3
Execute plot	PL	No data (waits to talk)		3
Plot marker	PM	No data (waits to talk)		3
Plot device	PP	0 (select plotter)		2
	PP	1 (select printer)		2
Printer Control:				
Raster grid	RG	0 (off)		2
	RG	1 (on)		2
Raster text	RT	0 (off)		2
	RT	1 (on)		2
Plotter Control:				
Plot text	IT	0 (off)		2
	IT	1 (on)		2
Plot grid	IG	0 (off)		2
	IG	1 (on, solid line)		2
	IG	2 (on, dashed line)		2
Trace line type	TL	0 (Trace A solid, B solid)		2
	TL	1 (Trace A dashed, B solid)		2
	TL	2 (Trace A solid, B dashed)		2
	TL	3 (Trace A dashed, B dashed)		2
Pen Speed:				
Slow	PS	0 (5 cm/sec)		2
Fast	PS	1 (default; plotter-dependent)		2
Select Pens:				
Trace A	PA	1-8		2
Trace B	PB	1-8		2
Grid	PG	1-8		2
Text	PT	1-8		2
Limit Testing Commands				
Limit Testing:				
On, SRQ on failure	LQ	No data		3
On, no SRQ	LE	No data		3
Off	LC	No data		3
View limits	LV	0 (off)		2
	LV	1 (on)		2
Limit Mode	LM	0 (absolute)		2
	LM	1 (relative)		2
Limit registers (pair)	LR	0-8 (lower limit register number)		2

Table 3-9-9b. Remote-Only Commands.

Command	Mnemonic	Data Description	Message Format
Trigger Types:			
Immediate	T4	No data	3
Delayed	T5	No data	3
T5 w/o SRQ	T6	No data	3
Data Dumps:			
Extended status	D0	No data	3
Marker Amplitude	D1	No data	3
Marker Amp. & Freq.	D2	No data	3
Trace A	D3	No data	3
Trace B	D4	No data	3
Cal. data	D5	No data	3
Extnd. status w/o cal	D6	No data	3
CRT characters	D7	No data	3
D1 continuous	D8	No data	3
D2 continuous	D9	No data	3
Display:			
Graphics on	DG	No data	3
Annotation on	DA	No data	3
DA characters	LA	50 ASCII characters	2
Script on	DS	No data	3
Erase script	ES	No data	3
Script & trace comb.	DC	No data	3
Script lines 1 thru 6	L1-L6	50 ASCII characters	2
Graticule control	GR	0 (off)	2
	GR	1 (on)	2
Annotation	AN	0 (off)	2
	AN	1 (on)	2
Script lines	SR	0 (off)	2
	SR	1 (on)	2
Front-Panel Entry:			
Enable entry	EE	No data	3
EE, SRQ active	EQ	No data (enable "key pressed" SRQ)	3
EE clear	EC	No data	3
Data Transfer:			
Learn in	LI	100 bytes	3
Learn out	LO	(3585B→100 bytes)	3
Trace memory:			
Trace B in	BI	2004 bytes	3
Trace B out	BO	(3585B→2004 bytes)	3
Trace A in	AI	2004 bytes→3585B	3
Binary dump	BD	0-9 (3585B→2004 bytes)	2
Binary load	BL	0-9 (2004 bytes→3585B)	2
Op. Complete SRQ	CQ	No data (enable SRQ)	3
Disable CQ	CC	No data	3
A-B ref. level	OR	0-1023	2
Spec Tests:			
Test modes	TE	00-14 (see Table 12)	2
Test modes	RC [†]	600-609 (same as TE)	2
Single loop	SL	0 (off)	2
	SL	1 (on; same as TE06)	2
Tracking Offset	TO	0 (off)	2
	TO	1 (on; same as TE07)	2

[†] These codes, though redundant, are included to assure compatibility with existing 3585A programs.

Remote Operation

Trigger Modes.

The 3585 has three types of programmable trigger modes: Immediate Trigger, Delayed Trigger with SRQ, and Delayed Trigger without SRQ.

T4 – Immediate Trigger. The output data specified by the dump mode is immediately transferred to the output buffer (except D3 and D4). If the marker is not displayed (i.e., when the display line is on) the last marker reading is transferred to the output buffer.

T5 – Delayed Trigger. A T5 trigger performs exactly like a T4 trigger for dump modes D3, D4, D5, D6, and D7. In the other dump modes a T5 trigger performs as follows.

1. The marker data is transferred to the output buffer when the sweep is equal to the marker in continuous or single-sweep mode.
2. The sweep is rearmed in continuous and single-sweep mode.
3. In manual-sweep mode, the marker data is not transferred until the RBW and VBW settling times are complete.
4. The marker data transfer is delayed until after a counter reading is made and/or a noise reading is made if these functions are active.
5. SRQ is set when the output is ready. Bit 1 in the serial poll is set. SRQ is cleared automatically after the first output word is sent.
6. Output is delayed until the trigger conditions are met.
7. If the marker is not displayed, a T5 trigger performs the same as a T4 trigger.

NOTE

"T5" should be the last command of a command string.

T6 – Delayed Trigger without SRQ. This trigger mode functions the same as a T5 trigger. The difference is that SRQ is not used to indicate an output-ready condition.

Range Control.

When programming range, the auto-range key is automatically turned off. The codes for programming range are as follows:

Table 3-9-10. Range Programming Codes.

Programming Code	Range in 50 Ω Termination		
	dBm	dBV	Volts
R01	-25	-38	12.6 mV
R02	-20	-33	22.4 mV
R03	-15	-28	39.8 mV
R04	-10	-23	70.7 mV
R05	-5	-18	126 mV
R06	0	-18	126 mV
R07	+5	-8	393 mV
R08	+10	-3	707 mV
R09	+15	+2	1.26 V
R10	+20	+7	2.24 V
R11	+25	+12	3.98 V
R12	+30	+17	7.07 V

Programming Marker Position.

The marker may be positioned to any of its 1001 positions on the A or B trace by using an MK command with the appropriate position number. This command will also turn on the Marker key in the Marker/Continuous Entry section. When using an MK command the following conditions apply:

- Valid MK commands are MK 1 thru MK 1001.
- The next input character other than an ignored code or a number acts as the delimiter.
- Only four numbers are accepted, the rest are ignored.
- Leading zeros are suppressed.
- "MK" with no numbers is assumed to be "MK0."
- MK 1002 thru MK 9999 = MK 1001.
- MK0 = MK 1.
- The ASCII characters for minus and decimal point are treated as delimiting characters.

Remote Operation

Display Control.

Introduction. Two special alphanumeric display features are available via remote control. "Annotation" is one line of alphanumeric characters at the top of the screen, shown while displaying all the normal display text and traces. "Script" allows one to six lines of alphanumeric character strings near the middle of the screen, usually with the rest of the display dark. The codes controlling these two features are grouped into two general groups of operation: alphanumeric strings are either coupled to display traces or they are not coupled.¹

There are two display modes; graphics and script-only. The graphics mode (activated by the Display Graphics command) is the normal (default) mode. It shows whatever traces are active as well as the display text above and below the graticule. Annotation, as described above, appears only in the graphics mode. The "script-only" mode (activated by the DS command) displays the six script lines with the rest of the screen blank.

Annotation Display Mode (coupled). A 50-character alphanumeric display line may be placed on the CRT between the first and second horizontal graticule lines in this mode. Annotation can only be displayed in the graphics mode.

LA – Load annotation: Enter annotation alphanumerics.

DA – Display annotation. Displays the annotation line when trace A is displayed. Turning off trace A turns off the annotation line as well.

DG – Display graphics. Changes to graphics mode and turns the annotation line off.

After an "LA" command ASCII characters may be entered according to the following conditions:

- The LA command erases the present line.
- Characters following an LA command are entered from the left.
- Any number of characters greater than 50 are ignored.
- An entry string is terminated by a line feed.
- ASCII character codes outside the range 28–127 are ignored.
- The annotation line is cleared by turning the power off. It is not cleared by an instrument preset or a device clear; however, it is turned off.
- The annotation is only displayed when trace A is on.

¹ The display control commands of the 3585A (DG, DS, DA) all worked such that annotation and script lines were coupled to a trace; they disappeared when the trace they were coupled to was turned off. The 3585B command set includes these commands to maintain compatibility with existing software. However, two new commands have been added that allow control of the script and annotation without respect to displaying a trace. They are AN (annotation on/off) and SR (script on/off). We recommend use of these features as described under "Uncoupled Annotation and Scripts." If you use the AN and SR commands, don't use DC and DA commands; the results could be confusing.

One example of how this display mode might be used is for screen titles. An example using HP BASIC, is:

```
OUTPUT 711;"DA LA HARMONIC DISTORTION TEST"
```

This command displays the words "HARMONIC DISTORTION TEST" at the top of the screen.

To turn off the annotation display line the following command could be used:

```
OUTPUT 711;"DG"
```

Another way to turn off the annotation line is to turn trace A off. Turning the annotation display off does not erase the annotation string.

Script Display Mode (coupled). The script mode allows you to display a set of six alphanumeric strings, each of up to 50 characters. In this mode the normal graphic display is turned off and only the six lines of script are displayed. The script mode is controlled in the following manner:

L# – Load alphanumeric characters for script line where # is a number from 1 to 6.

ES – Erase script. Erases all six lines of script.

DS – Display script. Changes to the script mode and turns the script display on.

DG – Display graphics. Turns the script display off and the graphics display on.

DC – Display combination of graphics and script lines. Allows the script display and the B trace to be simultaneously displayed. Script lines are not displayed when trace B is turned off.

Data may be entered using the L1, L2, L3, L4, L5, or L6 commands to specify the desired line with the following conditions:

- The L# (L1-L6) command erases the present line.
- Characters following an L# command are entered from the left.
- Any number of characters greater than 50 are ignored.
- An entry string is terminated by a line feed.
- ASCII character codes outside the range 28–127 are ignored.
- The Script display is cleared by turning the power off. It is not cleared by an instrument preset or a device clear; however, it is turned off.

Remote Operation

An example of the script mode using the HP BASIC programming language is:

```
OUTPUT 711; "ES DS L1HELLO"
```

In the command string example the display is erased (ES), turned on (DS), and the word "HELLO" is displayed on line one (L1). To put the words "SPECTRUM ANALYZER" on the second line (L2) the command would be:

```
OUTPUT 711; "L2SPECTRUM ANALYZER"
```

Lines 3 thru 6 may be programmed in this manner also. The alphanumeric of Lines 1 thru 6 may be individually changed at any time without changing the contents of the other lines by using a command similar to the one above. This can be done even if the script is not displayed.

Another way of using the script mode is to have the script and the B trace displayed simultaneously. In other words, the script display becomes a part of the B trace. This is accomplished with a "DC" command (display combined trace and script). Data entry for the individual lines in the "DC" mode must follow the same rules as those used in the "DS" mode outlined previously.

Uncoupled Annotation and Scripts. If the DS (display script) command is active, the analyzer is in script mode and only the script lines are displayed. If the DG (display graphics) command is active, the analyzer is in the display mode and annotation or script lines may be controlled with the AN and SR commands. The commands used to load the strings (LA and L1-L6) are the same as described previously.

DG – Turn on graphics mode.

DS – Displays 6 lines of script by themselves

AN1 – Displays the annotation string (regardless of trace A status).

AN0 – Turns off the annotation string.

SR1 – Display script lines in graphics mode (regardless of trace B status).

SR0 – Turn off display of script lines.

In graphics mode, script lines may or may not be displayed. When in the script mode, only the script lines appear on the display.

```
OUTPUT 711;"DG AN1 LA HARMONIC DISTORTION TEST"
```

Turns on graphics, turns on annotation, and loads the annotation string which is immediately displayed.

```
OUTPUT 711;"AN0"
```

Turns the annotation string off.

```
OUTPUT 711;"ES DG SRI LIHELLO"
```

Erases all script lines, makes sure the graphics mode is active, turns on the script lines, and loads the string for the first of six possible script lines, which is immediately displayed.

```
OUTPUT 711;"SR0"
```

Turns off the displayed script line(s).

Graticule Control. On 3585s which display the graticule (as opposed to those with etched lines on the face of the CRT), the graticule may be turned on or off with the GR command. GR0 turns it off; GR1 turns it on. This feature may be toggled from the front panel by pressing (blue) . in the numeric keypad (where "." refers to the decimal point character).

Special Characters. The allowable characters for all special display modes are the ASCII codes 28 thru 127, with the following exceptions:

1. chr\$(28) = Ω
2. chr\$(29) = \pm
3. chr\$(30) = \
4. chr\$(31) = μ
5. chr\$(92) = $\sqrt{\quad}$ (square root)
6. chr\$(127) = ■

Remote Operation

Front-Panel Entry During Remote Operation.

When this feature is active, the analyzer responds to a front-panel key press by putting a number on the bus corresponding to the key pressed. This allows the controller to track analyzer front-panel key presses. The commands are:

EE – Enable Entry. When the analyzer receives the EE command, it begins responding to front-panel key presses by putting numbers on the bus. The correspondence between keys and numbers is shown in Table 3-9-11. Whenever a key is pressed, Status Bit B2 is set. If EE is active no SRQ is activated.

EQ – Enable Entry with SRQ. This command acts the same as the “EE” command except that SRQ is also set when Status Bit B2 is set.

EC – Enable Entry Clear. This command disables the “EE” or “EQ” mode. Normal keyboard operation is resumed.

Some of the uses for the “EE” and “EQ” commands are to check for front panel key presses and entering numbers or decisions into a controller. An example of the “EE” command is:

```
10 OUTPUT 711; "EE"  
20 ENTER 711; USING "#,B"; A  
30 PRINT A  
40 GOTO 20
```

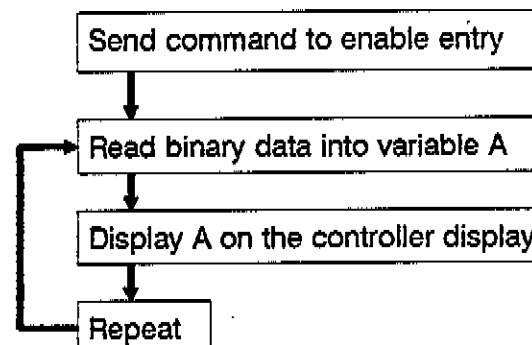

This program displays (on the controller monitor) the decimal code for any key that is pressed.

The “EE” mode can also be used for entering decisions. For example, the following information could be displayed on the analyzer CRT in the script mode:

```
I.F. Filter Adjustment: Enter number for desired test  
  
I.F. Filters 1 and 2 . . . . . 1  
I.F. Filters 3 . . . . . 2  
I.F. Filters 4 and 5 . . . . . 3
```

The user enters either 1, 2, or 3 on the analyzer keyboard. In the “EE” mode the instrument outputs the code for the key as listed in Table 3-9-11. This key code can then be decoded and used for a subroutine decision which will execute the selected test. This is feasible since each key on the analyzer has a known, unique code which can be decoded and used.

Table 3-9-11. Decimal Values Returned Under EE and EQ.

Notes		Key	Value
<i>Instrument Preset does not have a key code.</i>		RBW/VBW/ST Keys:	
<i>* Values for shifted functions (<shift> <key>) are "listed value + 128," except for the functions MKR/Ofs→ Step, (knob) Off, Full Sweep, and Display Line Clear (see list for values).</i>		Coupled to Span	16
		Preset RBW	17
		RBW Hold	18
		RBW	8
		Video	9
		Sweep Time	10
		Input Keys:	
		1 MΩ	21
		50Ω	19
		75Ω	20
		Range Keys:	
		Autorange	22
		Range	11
		Ref. Level Track	23
		Display Keys:	
		Clear Trace A	32
		Store Trace A	33
		View Trace A	34
		View Trace B	35
		Max Hold	36
		A-B	26
		Marker/Continuous Entry Keys:	
		Marker	25
		Manual Marker	68
		Marker Ref. Level	27
		Marker Center Freq	67
		Display Line On	28
		Display Line Clear*	37
		(knob) Off*	29
		Noise Level	31
		Signal Track	72
		Peak Search	73
		Next Peak	74
		Counter	65
		Offset→ Span	38
		MKR→Center	39
		MKR→Ref. Level	30
		Enter Offset	66
		MKR/Ofs→ Step*	64
		Knob	69, 70
		Offset	24
		Plot/Limit Keys:	
		Plot Setup	76
		Plot	77
		Plot Marker	78
		HP-IB Status Key:	
		Local	47
Key	Value		
Entry Keys:			
Center Frequency	0		
Frequency Span	1		
Start Frequency	2		
Stop Frequency	3		
Center Freq. Step Size	4		
Reference Level	5		
dB/Div	6		
Reference Level Volt	7		
Up	41		
Down	40		
MHz/dBm/V	12		
kHz/dBV/mV	13		
Hz/dB/μV	14		
sec	15		
Full Sweep*	44		
Save	42		
Recall	43		
Numeric Entry Keys:			
0	48		
1	49		
2	50		
3	51		
4	52		
5	53		
6	54		
7	55		
8	56		
9	57		
-	45		
.	46		
Sweep Keys:			
Continuous Sweep	58		
Single Sweep	59		
Manual Sweep	60		
Trigger Keys:			
Free Run	61		
Line Trigger	62		
External Trigger	63		

Remote Operation

Test Modes

The 3585 may be configured to perform special tests on internal circuits. The commands that activate these configurations are Test (TE nn), Tracking Generator Offset (TO n), and Single Loop (SL n). The Test commands are documented in Table 3-9-12. The TO and SL commands are variations of test modes 6 and 7.

Table 3-9-12. Test Modes.

Entry	Function
01	Normal instrument operation but with calibration disabled and no calibration offsets.
02	Internal 10 MHz switched into input; otherwise normal instrument operation.
03	Internal 10 MHz switched into input, calibration disabled, and no calibration offsets.
04	Tracking generator switched into input; otherwise, normal operation
05	Tracking generator switched into input; no calibration or calibration offsets.
06	Local oscillator performs in single loop mode for all bandwidths.
07	CF Step Size parameter used as tracking generator offset on a calibration. Tracking generator frequency is set positive with respect to analyzer tuned frequency. Maximum offset is 1.5 kHz.
08	Displays the tracking generator 10.35 MHz VCXO tuning curve on-screen with the vertical scale equal to CF Step Size. The counter reads frequency deviation above and below 10.35 MHz. A CF Step Size > 500 Hz exercises the coarse VCXO tuning DAC, while CF Step Sizes \leq 499 Hz exercise the fine DAC with the coarse DAC held at its current position. This mode is activated when the counter is turned on.

Test modes 09 through 14 are described in the Service Manual.

The test modes are chosen by entering TE nn where nn is the two-digit entry code for the desired test as described in Table 3-9-12. The test mode is then put into effect by executing a device clear. The following command sequence is an example in HP BASIC:

```
OUTPUT 711;"TE05"    ! Select test 5
CLEAR 711            ! Activates test mode 5
```

An instrument preset or device clear command must be issued after the test number command string to activate the test mode. The test mode is active until the next instrument preset or device clear command is issued.

SL n – Single loop mode, on/off. The command SL1 is analogous to TE06 except that it displays the message "Single loop mode ON." The command SL0 disables the single loop mode and displays the message "Single loop mode OFF." This returns the analyzer to its default condition even if it is in test mode 6.

TO n – Tracking generator offset, on/off. This command functions the same as TE07 with 2 exceptions:

1. After a TO1 command, the range of the offset frequency parameter (entered in the CF Step Size parameter) is expanded beyond the 1.5 kHz specification. For offset frequency entries from 0 to 5 kHz, the tracking generator offset is set to the frequency entered, unless it is out of the usable range of the tracking generator (use TE08 to determine range).

For offset frequency entries > 5 kHz and < 15 kHz, the offset used is 10 kHz below the value entered (maximum offset is ± 5 kHz), unless this results in a value out of the usable range of the tracking generator. If a negative tracking generator offset should cause the tracking generator receive to a negative-frequency request, it responds with the absolute value of the frequency requested.

The 5-to-15 kHz range allows negative as well as a positive offset frequencies. Also, the TO command allows use of the tracking generator beyond the 1.5 kHz limit imposed by the RC607 command.

NOTE

This does not imply that the tracking generator range in any specific 3585 is guaranteed to operate beyond the 1.5 kHz specification. Most do, however, and this command allows use of that range.

2. The TO1 command causes the message "Track gen offset ON" to be displayed and the TO0 command causes the message "Track gen offset OFF" to be displayed. After using the TO command or changing the CF Step Size, you must force a calibration to ensure the correct tracking generator offset. This may be done with the AC1 command.

Binary Data Mode.

The analyzer has a group of commands which handle binary data. These commands are used to send or receive binary data describing the traces or present control settings. The first two bytes of binary data are always sent or received with all bits set. These two bytes act to synchronize the transfer.

Binary Data Input. When an ASCII command is received that indicates a binary input to the analyzer, the information following the command is treated as binary data. If a carriage return or line feed is sent after the ASCII command to enter a binary mode, it will be ignored. Enough binary data must be sent to the analyzer to satisfy the given command conditions. After receiving the last binary word, the analyzer will return to receiving information in ASCII.

Binary Data Output. For a binary output from the analyzer, a set of binary words which will satisfy the binary command conditions is output when the analyzer is addressed to talk. None of the binary output commands require a trigger to start their operation. Any previous trigger or dump is terminated by a binary operation; however, the previous dump mode is remembered and can be triggered to output data as soon as the binary operation is completed.

Binary Commands. The binary operations are as follows:

LO – Learn mode out. When this command is received the state of the instrument is captured, as in the Save key function, and is output as a set of 100 bytes.

Remote Operation

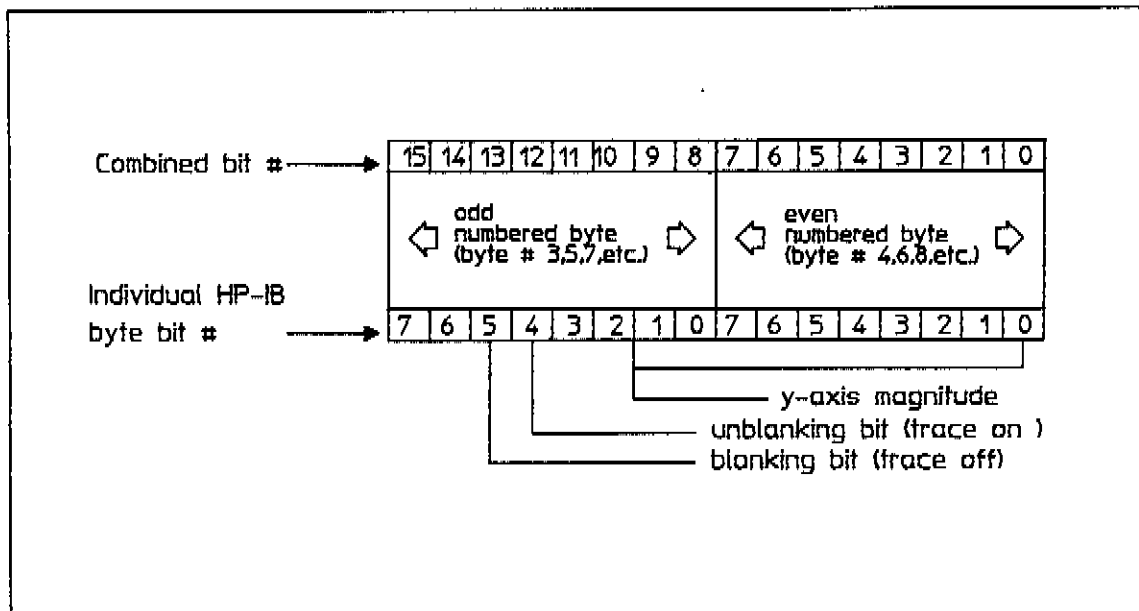

Figure 3-9-2. Display Trace Word in Binary Format.

LI – Learn mode in. When this command is received the instrument accepts the binary data obtained by a “LO” command as the new state of the instrument. After the command is received, the next 100 bytes are input to the instrument. After the last word is received by the analyzer, the new state of the instrument becomes active. It is important that the order of the binary words not change from that acquired with a “LO.”

BI – B trace in. This command allows the B trace to be generated from the HP-IB. The B trace consists of 1002, 16 bit data words which represent the Y-axis magnitude for each X-axis location. The display is generated by connecting each Y-axis magnitude in adjacent X-axis locations with a straight line. Each of the 16 bit data words are generated from the HP-IB by combining bytes in pairs. These pairs are received and combined as shown in Figure 3-9-2.

In this mode the first two bytes must be sent with all bits set to one. These first two bytes are not used in the display. Therefore, 1002, 16 bit words or 2004 HP-IB words must be sent in order to define one complete display.

After each byte-pair is received and combined, it is stored in consecutive X-axis locations starting from the left of the CRT. After the bytes are combined, the binary code may be interpreted as follows:

Bits 0 to 9. The binary magnitude of the Y-axis deflection with the bottom of the screen equal to 0 and the top of the screen equal to decimal 1023. The reference level is equal to decimal 1000.

Bits 10, 11, 14, 15. Ignored.

Bits 12 and 13. These bits serve to blank (bit 13) and unblank (bit 12) the trace. In other words, they serve to turn the trace on and off. When bit 12 is received set, all the line segments following will be turned on. Once bit 12 is received set, the analyzer ignores bit 12 until bit 13 is set. When bit 13 is received set, all the

in the same word as the blank or unblank bit. Care must be taken not to have bits 12 and 13 set at the same time.

AI—A trace in. This is the same as "BI" except that it acts on trace A.

NOTE

If the instrument is sweeping or a calibration occurs, a trace loaded in the "AI" mode could be disturbed or lost. Care must be taken to insure that these conditions do not occur while the trace is being loaded or during the time that you wish to retain this trace.

BD, BL—Binary dump or load of trace memory registers 0 through 9. The data format is similar to display data moved by the BO, BI, and AI commands: two bytes of value 255 (or one word of value -1) followed by 2002 bytes (or 1001 words) of data.

Trace data, as transferred with the BD and BL commands, is always represented in measurement units; the values are stored in units of .01 dBV or .01 dB (if the trace is A-B data). A value of -17.2 dBV would be represented as a 16-bit integer -1720.

The BD and BL data format does not contain any display format information. This is the major difference them and the BO, BI, and AI commands, which deal strictly with display units and include embedded display formatting information.

The following program illustrates the use of the BD and BL commands and a number of other techniques.

```

10 Addr=711
20 INTEGER A(1000)
30 CLEAR Addr
40 REPEAT
50 OUTPUT Addr;"D6T4"
60 ENTER Addr USING "#,B,B";B,C
70 UNTIL BINAND(B,3)⟷3
80 OUTPUT Addr;"S2CQS2"
90 REPEAT
100 UNTIL BINAND(SPOLL(Addr),8)⟷0
110 OUTPUT Addr;"TS5,BD5"
120 ENTER Addr USING "#,W,1001(W)";X,A(*)
130 Max_val=MAX(A(*)/100
140 PRINT "THE HIGHEST PEAK IS ";Max_val;" DBV"
150 FOR I=0 TO 1000
160 A(I)=I-4800
170 NEXT I
180 OUTPUT Addr USING "#,K,W,1001(W)";"BL6";-1;A(*)
190 OUTPUT Addr;"TR6"
200 END

```

Remote Operation

Line 30 does an instrument preset. Since the 3585 autoranges for a while after a preset, lines 40 through 70 wait for the autorange to finish. Line 50 causes the 3585 to dump its extended status (two bytes), and line 60 reads in this result. The lower two bits of the first byte are both set as long as the autorange is in progress, so line 70 causes the loop to repeat until the autorange has finished.

Line 80 puts the 3585 into single-sweep mode, enables the operation-complete interrupt, and then restarts another single sweep. The reason that the S2 command was repeated is that the S2 restarts the sweep only if the 3585 is already in single sweep mode.

Lines 90 and 100 wait for the SRQ from the completion of the single sweep.

Line 110 saves the current trace A in trace memory 5, and requests trace memory 5 to be dumped to the bus.

Line 120 captures this information in integer array A. The variable X is used to read and ignore the beginning-of-binary-data flag, which is two bytes of 255, or one word (integer) of -1.

NOTE

Binary dumps may also be read by doing an unformatted enter into an integer array with a size of 1002 words; the first array element will have a value of -1, which is the integer data flag.

Lines 130 and 140 find the maximum value on the trace, and print out this value in dBV.

Lines 150-170 put some data into array A. Line 180 writes this data into trace register 6, and line 190 recalls this data into the A trace. Since the 3585 is in single sweep mode and the program waited for the completion of the sweep, this data is not overwritten. At the completion of this program, you should see a diagonal line in the display.

Programming the A-B Trace Position

The center of the A-B trace (0 dB reference) may be changed from the default value of 500 (fifth graticule line from bottom; middle of screen) to any value from 0 to 1023. This could be used to solve a display clipping problem. For example, if the command "OR200" is sent to the 3585, subsequent A-B traces will use the second graticule line from the bottom of the screen as the 0 dB reference level.

This command does not change any display information active when it is executed; only subsequently displayed graphics and text are affected. This value is saved and recalled with the instrument state. The value is reset to 500 by Instrument Preset.

This feature is available on the front panel by activating the Display Line and positioning it at the new reference point and then pressing pressing (blue) A-B.

Status Byte

The status byte is an eight-bit word that the 3585 puts on the data bus when it receives a serial poll (from a controller). The state of the individual bits indicates the status of an internal condition or function. Table 3-9-13 defines the 3585 status bits and the events or conditions that set and clear each bit. A status bit is set when the condition it represents changes from false to true. When a bit is set, bit B6 is also set and an SRQ is generated.

Table 3-9-13. Status Byte Definition.

Bit *	Value	Description
B0	1	Command not understood (syntax error).
B1	2	T5 trigger complete, data ready.
B2	4	A key has been pressed while EQ is active.
B3	8	Operation complete. Cleared by a serial poll or †
B4	16	Limit test failed. Cleared by a serial poll or †
B5	32	Not used.
B6	64	RQS. Requested service.
B7	128	Not used.

* An instrument preset or a serial poll clears all bits of the status byte.

† Cleared by any of the following commands or their front-panel equivalents: S1, S2, S3, C2, CA, RC, PL, and PM.

Control of SRQ for Status Bits 3 and 4.

See earlier discussion on front-panel entry for information concerning control of SRQ with B2.

CQ—Operation-complete SRQ. If the CQ command is given to the analyzer, it generates an SRQ at the completion of each measurement. In continuous sweep and single sweep modes, this occurs at the end-of-sweep. In manual sweep mode, it occurs after every measurement is complete. This also occurs at the completion of the *plot* and *plot-marker* commands. Status bit B3 is set (value 8) to indicate that the SRQ was caused by the *operation-complete* flag.

CC—Clear CQ command. CC disables the operation-complete SRQ; bit B3 is not set.

LQ—Limit testing enabled with SRQ on failure. When the LQ command is given to the analyzer, the limit test feature is enabled and status bit B4 is set (causing an SRQ) each time a limit test fails.

LE—Limit testing enabled with no SRQ on failure. When the LE command is given to the analyzer, the limit test feature is enabled but status bit B4 is not set (and no SRQ is generated) upon failure.

LC—Limit testing off. Also disables the limit test SRQ. Refer to "Limit Testing" in Chapter 1.

Remote Operation

Serial Poll.

When the controller senses that the SRQ (bus management) line is set, it may conduct either a serial poll or a parallel poll to determine which device(s) require service. A parallel poll accesses the RQS bit of the status bytes from up to eight machines at a time. The 3585 has no parallel poll capability.

The serial poll is issued by the active controller along with a specific address. If the address matches the address setting of the 3585, it responds by putting its status byte on the data lines (when it is addressed to talk). The controller (should be programmed so that it) checks the RQS bit and any reasons that it might be set, as indicated by the rest of the status bits and takes appropriate action. All bits in the 3585 status byte are cleared by a serial poll.

Plotting via HP-IB.

When the analyzer receives a PL command, it waits to be addressed to talk. When it receives its talk address, it then outputs a string of HP-GL commands as it does when the plot command is generated from the front panel. The following program illustrates a programming method to plot and recover control of the bus when the plot is complete. The analyzer's bus address is assumed to be 11 and the plotter's is 5.

```
10  OUTPUT 711;"PP1,PD,PL"  
20  SEND 7;UNL;TALK 11;MLA;LISTEN 5  
30  ENTER 7 USING "/"
```

Line 10 (sent to the analyzer) selects "plotter" as the plot device, sets all options to their default values, and issues the plot command to the analyzer.

Line 20 sets up addressing for devices on the bus. UNL (unlisten) is a bus command issued to all devices on select code 7 to quit listening (except for further bus commands). TALK 11 addresses the analyzer to talk (as soon as the controller releases control of the bus). MLA (my listen address) is a command by the controller to itself which addresses the controller to listen. This allows the controller to eavesdrop on the transfer and regain control of the bus when the plot is complete. LISTEN 5 addresses the device at address 5 (the plotter) to listen. This sets up the plotter to receive the characters sent by the analyzer.

Line 30 sets the controller to watch the bus for the line-feed character. The analyzer sends a line-feed character as the last character of the plot file. When the controller sees the line-feed, it recovers control of the bus and continues execution of the program.

NOTES

- 1. This technique doesn't work when driving a printer. The analyzer sends CR/LF to advance lines when sending text strings. The LF would cause the controller to resume control of the bus in the above example, possibly before the end of the plot. Refer to Appendix 3-A for an example that supports using a printer as a plot device.*
- 2. PM (plot marker) works via the HP-IB the same as from the front panel.*
- 3. The PD command sets the plotter options to their default settings but does not affect the selected device or the printer options. The PD command does not select the plotter as the plot device.*

Special Considerations For Remote Operation

Special consideration should be given to the use of the Auto Range and Marker commands when taking measurement data during remote operation.

1. It is best to explicitly set a fixed value for range. Using autoranging may result in receiving bad measurement data, if the measurement data is taken while an autorange is in progress. If you must use autorange while in remote operation, see programming example 11 in Appendix 3-A for a demonstration of autoranging control and a way to detect when autoranging is complete.
2. Make sure that marker information is valid before issuing any of the MKR→ commands or taking marker data for measurement data. The commands in this category are:
 - MO – Marker Offset (entry)
 - MR – Marker→Reference ReferenceLevel
 (If the counter is on)
 - MC – Marker→Center CenterFrequency
 - MS – Marker Offset→Step
 - OS – Offset→Span

To ensure valid marker data after a setup change, enter the marker value with a T5 or T6 trigger so that the analyzer does not respond to the ENTER command until the marker is valid; e.g.:

```
OUTPUT 711;"D1T6"
ENTER 711;A
```

Programing The Analyzer For Maximum Speed.

The most important contribution to minimizing program execution time is control of the calibration feature. If Autocalibration is on, a calibration occurs every time the center frequency changes (above 150 kHz) or the resolution bandwidth is changed. To control calibration, turn it off (with AC0) before making changes. Then, after the new parameter values have been entered, turn calibration back on (with AC1). Turning calibration on causes a calibration.

Other gains can be made use of single sweeps, using a fixed range instead of auto range, and turning off the limits view if the limits trace are going to be changed.

- The processor has 50% more time while it is not sweeping than during a sweep. Use single sweep mode and take measurements after the sweep is complete.
- Using a fixed range value is better than using auto ranging.
- Redrawing limits traces (due to a change) reduces program performance, so it is best not to view the limits traces if they are going to be changed often.

HP-IB Command Quick Reference

Sorted by mnemonic

AB	A-B on/off	FB	stop frequency	PT	plot pen text
AC	cal on/off	FL	full sweep	R01	-25 dBm range
AI	load A trace	FS	frequency span	R02	-20 dBm range
AL	ref level track on/off	GR	graticule on/off	R03	-15 dBm range
AN	annotation on/off	HZ	units, Hz	R04	-10 dBm range
AR	auto range on/off	I1	input 1 M Ω	R05	-5 dBm range
BD	dump trace memory	I2	input 50 Ω	R06	0 dBm range
BE	beeper on/off	I3	input 75 Ω	R07	5 dBm range
BG	bus debug on/off	IG	plot grid type	R08	10 dBm range
BH	bw hold on/off	IL	turn knob ccw	R09	15 dBm range
BI	load B trace	IR	turn knob cw	R10	20 dBm range
BL	load trace memory	IT	plot text on/off	R11	25 dBm range
BO	dump B trace	KZ	units, kHz	R12	30 dBm range
C1	rpg [†] marker	L1	load script line 1	RA	range prefix
C2	rpg manual frequency	L2	load script line 2	RB	resolution bandwidth
C3	rpg reference level	L3	load script line 3	RC	recall
C4	rpg center frequency	L4	load script line 4	RG	print grid on/off
C5	rpg display line	L5	load script line 5	RL	reference level log
C6	rpg off	L6	load script line 6	RP	next right peak
CA	clear A trace	LA	load annotation	RT	print text on/off
CC	clear op complete SRQ	LC	clear limit test	RV	reference level volts
CF	center frequency	LE	limit test on	S1	continuous sweep
CL	clear display line	LI	load instr state	S2	single sweep
CN	counter on/off	LO	dump instr state	S3	manual measurement
CP	coupled to span on/off	LM	limit mode abs/rel	SA	store trace A into B
CQ	op-complete SRQ on	LP	next left peak	SB	recall trace B into A
CS	cf step size	LQ	limit test on with SRQ	SC	units, seconds
D0	dump extended status	LR	limit register select	SL	single loop on/off
D1	dump marker amplitude	LV	view limit on/off	SP	peak search
D2	dump marker amplitude, freq.	MC	marker to center frequency	SR	script on/off
D3	dump A trace, ASCII	MH	max hold on/off	ST	sweep time
D4	dump B trace, ASCII	MK	set marker location	SV	save
D5	dump calibration registers	MO	enter offset	T1	trigger free run
D6	dump extended status	MR	marker to reference level	T2	trigger line
D7	dump display alphas	MS	marker offset to step	T3	trigger external
D8	D1 continuous	MV	units, mV	T4	immediate dump
D9	D2 continuous	MZ	units, MHz	T5	delayed dump with SRQ
DA	display annotation	NL	noise level on/off	T6	delayed dump
DB	units, dB	NP	next peak	TA	view trace A on/off
DC	display combined	OF	offset on/off	TB	view trace B on/off
DD	dB/division	OR	A-B reference level	TE	test
DG	display graphics	OS	offset to span	TL	plot linetype
DL	display line amplitude set	PA	plot pen trace A	TO	tracking gen. offset on/off
DM	units, dBm	PB	plot pen trace B	TP	signal track on/off
DN	down	PD	plot defaults	TR	trace recall
DS	display script	PG	plot pen grid	TS	trace save
DV	units, dBV	PL	begin plot or print	UP	up
EC	clear EE, EQ modes	PM	begin plot or print marker	UV	units, micro volts
EE	send keys to bus	PO	startup option	VB	video bw
EQ	EE with SRQ	PP	select plot device	VL	units, volts
ES	erase script	PR	preset coupled functions		
FA	start frequency	PS	plot speed		

[†]RPG is short for rotary pulse generator (knob)

HP-IB Command Quick Reference

Sorted by command name

-25 dBm range	R01	dump marker amplitude, freq.	D2	range prefix	RA
-20 dBm range	R02	dump marker amplitude	D1	recall	RC
-15 dBm range	R03	dump trace memory	BD	recall trace B into A	SB
-10 dBm range	R04	enter offset	MO	ref level track on/off	AL
-5 dBm range	R05	erase script	ES	reference level log	RL
0 dBm range	R06	frequency span	FS	reference level volts	RV
5 dBm range	R07	full sweep	FL	resolution bandwidth	RB
10 dBm range	R08	graticule on/off	GR	rpg [†] center frequency	C4
15 dBm range	R09	immediate dump	T4	rpg display line	C5
20 dBm range	R10	input 1 M Ω	I1	rpg manual frequency	C2
25 dBm range	R11	input 50 Ω	I2	rpg marker	C1
30 dBm range	R12	input 75 Ω	I3	rpg off	C6
A-B reference level	OR	limit mode abs/rel	LM	rpg reference level	C3
A-B trace on/off	AB	limit register select	LR	save	SV
D1 continuous	D8	limit test on	LE	script on/off	SR
D2 continuous	D9	limit test on with SRQ	LQ	select plot device	PP
EE with SRQ	EQ	load A trace	AI	send keys to bus	EE
annotation on/off	AN	load B trace	BI	set marker location	MK
auto range on/off	AR	load annotation	LA	signal track on/off	TP
beeper on/off	BE	load instr state	LI	single loop on/off	SL
begin plot or print	PL	load script line 1	L1	single sweep	S2
begin plot or print marker	PM	load script line 2	L2	start frequency	FA
bus debug on/off	BG	load script line 3	L3	startup option	PO
bw hold on/off	BH	load script line 4	L4	stop frequency	FB
cal on/off	AC	load script line 5	L5	store trace A into B	SA
center frequency	CF	load script line 6	L6	sweep time	ST
cf step size	CS	load trace memory	BL	test	TE
clear A trace	CA	manual measurement	S3	trace recall	TR
clear EE, EQ modes	EC	marker offset to step	MS	trace save	TS
clear display line	CL	marker to center frequency	MC	tracking gen. offset on/off	TO
clear limit test	LC	marker to reference level	MR	trigger external	T3
clear op complete SRQ	CC	max hold on/off	MH	trigger free run	T1
continuous sweep	S1	next left peak	LP	trigger line	T2
counter on/off	CN	next peak	NP	turn knob ccw	IL
coupled to span on/off	CP	next right peak	RP	turn knob cw	IR
dB/division	DD	noise level on/off	NL	units, Hz	HZ
delayed dump	T6	offset on/off	OF	units, MHz	MZ
delayed dump with SRQ	T5	offset to span	OS	units, dB	DB
display annotation	DA	op-complete SRQ on	CQ	units, dBV	DV
display combined	DC	peak search	SP	units, dBm	DM
display graphics	DG	plot defaults	PD	units, kHz	KZ
display line amplitude set	DL	plot grid type	IG	units, mV	MV
display script	DS	plot linetype	TL	units, micro volts	UV
down	DN	plot pen grid	PG	units, seconds	SC
dump A trace, ASCII	D3	plot pen text	PT	units, volts	VL
dump B trace	B0	plot pen trace A	PA	up	UP
dump B trace, ASCII	D4	plot pen trace B	PB	video bw	VB
dump calibration registers	D5	plot speed	PS	view limit on/off	LV
dump display alphas	D7	plot text on/off	IT	view trace A on/off	TA
dump extended status	D0	preset coupled functions	PR	view trace B on/off	TB
dump extended status	D6	print grid on/off	RG		
dump instr state	LO	print text on/off	RT		

[†]RPG is short for rotary pulse generator (knob)

APPENDIX 3-A PROGRAMMING EXAMPLES USING HP BASIC PROGRAMMING LANGUAGE

The following examples are provided to assist you in developing programs for the 3585 when HP-BASIC is being used on a system controller. In all cases, it has been assumed that the 3585 has been set for HP-IB bus address 11.

Example 1: This is a basic programming statement which accomplishes the following:

Address the 3585 to listen; Send program data for:

- Center Frequency 10 MHz (CF10MZ)
- Frequency Span 5 kHz (FS5KZ)
- Resolution BW 30 Hz (RB30HZ)
- Continuous Sweep (S1)

```
OUTPUT 711;"CF10MZ,FS5KZ,RB30HZ,S1"
```

Example 2: This programming statement executes the same commands as the statement in Example 1; however, in this example the command string is written in accordance with the maximum programming speed guidelines at the end of Chapter 9. Try both Example 1 and 2 and note the difference in programming time.

```
OUTPUT 711;"AC0,CF10MZ,FS5KZ,RB30HZ,AC1,S1"
```

Programming Examples

Example 3: Harmonic distortion measurement using the Manual Mode

The power and speed of the 3585 Manual Mode can be demonstrated with this program. When looking for Harmonic Distortion products, reduction of the Resolution Bandwidth is often necessary to separate the signals from the noise floor. With the Manual Mode, the Resolution Bandwidth can be reduced as necessary while keeping the full 40 MHz span. The 3585 may now be programmed to the discrete frequencies of interest with the chosen resolution. Note that the sweep time is irrelevant: The time required to make the measurement is entirely determined by the IF settling and Calibration time.

```
10      !
20      ! EXAMPLE 3: HARMONIC DISTORTION MEASUREMENT USING MANUAL MODE
30      !           FUNDAMENTAL AT 2 MHz
40      !
50      D85=711                ! Define 3585 bus address
60      CLEAR D85              ! Make sure of 3585 state
70      OUTPUT D85;"R06"       ! Select 0 dBm range
80      OUTPUT D85;"RB30HZ"    ! Set for RBW of 30 Hz
90      FOR I=1 TO 5           ! Loop for fund. and 4 harm.
100     OUTPUT D85;"S3";2*I;"MZ,D1,T5" ! Measure at 2I MHz
110     ENTER D85;A            ! Read result
120     PRINT "Harmonic # ";I;" : ";A;TAB(24);"dBm" ! Print results
130     NEXT I
140     !
150     END
```

In the above program, the 3585 is first set to its preset state by the device clear in line 60. This ensures consistent starting conditions. The 3585 is then set to its 0 dBm range: This is done so that it is not necessary to wait for the 3585 to complete its autorange. In this case, it was known that the fundamental signal was at approximately 0 dBm. Now, it's a simple matter of looping through the frequencies it is desired to measure, and printing out the results. The "S3" command puts the 3585 into manual mode, and allows the manual frequency to be entered. The "D1" command tells the 3585 that we're interested in the marker amplitude, and the "T5" command requests that the information should be output as soon as it has been measured. A sample printout is shown below.

```
Harmonic # 1 : -.2 dBm
Harmonic # 2 : -52.2 dBm
Harmonic # 3 : -62.3 dBm
Harmonic # 4 : -85.3 dBm
Harmonic # 5 : -69.3 dBm
```

Example 4: Measuring Power Line Sidebands with the Manual Mode.

Another example of using the Manual Mode with the full 40 MHz span is the measurement of power line sidebands. By using the 3 Hz Resolution Bandwidth we are able to resolve these sidebands. This program measures the 60 Hz sidebands around a 34 MHz signal by stepping the Manual frequency by the CF Step Size. After the measurement conditions have been programmed and calibrated, the calibration is turned off. This action helps save time and does not radically affect the 3585's measurement accuracy since such a narrow band of frequencies are being measured.

A carrier is assumed at 34 MHz. Since we don't know the amplitude of the carrier, lines 70 through 100 wait for the 3585 to finish its autorange function. Line 120 turns off calibration to save programming time, sets the manual frequency to 34 MHz, sets the center frequency step size to 60 Hz, sets up the RBW and VBW to the narrowest possible setting, performs a calibration, turns off cal again, and triggers a reading. The entered value, which becomes the marker amplitude in dBm because of the device clear, is entered into the variable B. Then, within a loop, the first three upper sidebands of the power line are measured, and printed in db down from the carrier.

```

10      !
20      !EXAMPLE 4: MEASURING POWER LINE SIDEBANDS WITH MANUAL MODE
30      !           CARRIER AT 34 MHZ, 60 HZ SIDEBANDS
40      !
50      D85=711
60      CLEAR D85                ! Ensure consistent conditions
70      REPEAT
80          OUTPUT D85;"D6T4"    ! Request ext. status read
90          ENTER D85 USING "#,B";A ! Enter first byte of status
100         UNTIL BINAND(A,3)<>3 ! Wait for autorange to finish
110         ! Set up for measurement
120         OUTPUT D85;"AC0,S3 34MZ,CS60HZ,RB3HZ,VB1HZ,AC1,AC0,D1,T5"
130         ENTER D85;B          ! Measure fundamental amplitude
140         PRINT "Fundamental amplitude: ";B;" dBm" ! Print absolute fund. ampl.
150         OUTPUT D85;"MR"      ! Move up to reference level
160         FOR I=1 TO 3
170             OUTPUT D85;"S3,UP,T5" ! Go to next 60 Hz sideband
180             ENTER D85;A        ! Read sideband amplitude
190             PRINT "Sideband Freq ";I*60;"Hz: ";A-B;" dB" ! Print results
200         NEXT I
210         !
220         END

```

A sample printout from the above program is shown below.

```

Fundamental amplitude: -1.7 dBm
Sideband Freq 60Hz: -98.3 dB
Sideband Freq 120Hz: -96.4 dB
Sideband Freq 180Hz: -97.9 dB

```

Programming Examples

Example 5: Peak Search

This program determines the largest displayed response (independent of span), count it and enter the counted frequency as the Center Frequency. For illustrative purposes, this is done without using the "SP" command, which would greatly speed and simplify this program. It is assumed that the 3585 has been placed into the desired operating mode before this program is executed.

Line 80 puts the 3585 into dump mode 3, which dumps the A trace in ASCII. The 1001 enters within the loop read the values one at a time; the "USING" clause is necessary because the values are separated by commas. Whenever a value is found which is larger than previous values, its amplitude is remembered in B, and the corresponding bin number is remembered in C. Next, the marker is put into the bin with the peak response, the counter is enabled, and the frequency of the signal is read in. Next, the response is moved to the center of the screen with the "MC" command, and the counter is turned off.

Note the manner in which the Counter reading is made. The Counter must be triggered before reading its value or entering it as the Center Frequency (Mkr→CF). Programming the sequence, Counter on, Mkr→CF results in the Marker reading being entered as the Center Frequency instead of the Counter reading. A Noise Level reading is accomplished in much the same way. The Noise Level key is turned on, a "T5" trigger issued and the Noise Level read.

```
10      |
20      |EXAMPLE 5: PEAK SEARCH
30      |          FIND MAXIMUM RESPONSE AND CENTER ON IT
40      |
50      D85=711
60      B=-200
70      C=-200
80      OUTPUT D85;"D3,T4"
90      FOR I=1 TO 1001
100     ENTER D85 USING "#,K";A
110     IF I>4 AND A>B THEN
120         B=A
130         C=I
140     END IF
150 NEXT I
160     OUTPUT D85;"MK";C
170     OUTPUT D85;"CN1,D2,T5"
180     ENTER D85;A
190     OUTPUT D85;"MC,CN0"
200     PRINT "FREQ IS ";A
210     |
220     END
```

Example 6: Harmonic Levels and Total Harmonic Distortion

The program shown below allows you to measure the harmonic levels of any input signal from 250 Hz to 20 MHz. This example demonstrates displaying script with and without graphics.

The program works as follows: Press RUN. The program instructs you to place the marker on the peak of the signal you wish to analyze. Just to be helpful, the program sends an "SP" command, which puts the marker on the largest response in the display. Entry parameters may be changed as desired to easily view the signal of interest; when finished, press CONTINUE on the controller. The results, which include the fundamental frequency and amplitude, and the amplitude below the fundamental for harmonics 2 through 5, and the Total Harmonic Distortion is displayed on the 3585 screen.

```

10  !
20  ! EXAMPLE 6: HARMONIC LEVELS AND TOTAL HARMONIC DISTORTION
30  !
40  D85=711
50  CLEAR D85
60  OUTPUT D85;"ES,SR1,SP"           ! Display script & mkr to peak
70  OUTPUT D85;"L1Put the marker on the peak of the fundamental"
80  OUTPUT D85;"L2frequency. Press CONTINUE when ready"
90  LOCAL D85                       ! Allow manual control of 3585
100 PAUSE                          ! Wait for user to set up 3585
110 OUTPUT D85;"S3,CN1,T5"         ! Do a frequency count in manual mode
120 ENTER D85;B                    ! Wait for counter to finish
130 OUTPUT D85;"MC,MS,CN0,RL,DV,D2,T5" ! Set up measurement
140 ENTER D85;F,A                  ! Get frequency and ampl. of carrier
150 OUTPUT D85;"RB30HZ"           ! Narrower bw for better s/n
160 D=0
170 Maxharm=INT(4.01E+7/F)         ! Calc highest harmonic we can do
180 IF Maxharm>5 THEN Maxharm=5
190 FOR I=2 TO Maxharm             ! Loop through harmonics
200   OUTPUT D85;"CF,UP,D1,T5"     ! Trigger measurement at next harmonic
210   ENTER D85;Harm(I)           ! Read harmonic amplitude (in dBV)
220   Volts=10^(Harm(I)/20)       ! Calculate corresponding volts
230   D=D+Volts^2                 ! Sum volts squared
240 NEXT I
250 D=10*LGT(D)-A                  ! Calculate total distortion
260                               ! Display the results on the screen
270 OUTPUT D85;"ES,DS,L1Harmonic distortion results in dB below signal"
280 OUTPUT D85;"L2Fundamental = ";A;" dBV, ";F;"Hz"
290 FOR I=2 TO Maxharm-1
300   OUTPUT D85;"L";I+1;" Harmonic";I;" , ";Harm(I)-A;" dB"
310 NEXT I
320 D=INT(D*100)/100
330 OUTPUT D85;"L";Maxharm+1;" Harmonic";Maxharm;" , ";
340 OUTPUT D85;Harm(Maxharm)-A;" dB, THD = ";D;" dB"
350 LOCAL D85
360 !
370 END

```

Programming Examples

An example of the resulting 3585 display is shown below:

```
Harmonic distortion results in dB below signal
Fundamental = -13.3 dBV, 5.E+6Hz
Harmonic 2, -45.7 dB
Harmonic 3, -55.1 dB
Harmonic 4, -69.5 dB
Harmonic 5, -67.9 dB, THD = -45.19 dB
```

Example 7: Dumping display to raster-graphics capable printer

This example shows how the display may be printed on an HP printer which is capable of printing raster graphics. Examples of printers which can be used here are the 9876A, or the ThinkJet printer. Line 70 selects the printer to be the output device, enables an operation-complete srq, and starts the output. The 3585 does not go into output mode until it senses that it has been addressed to talk (in the next line). Line 80 configures the bus: We are assuming here that the 3585 is at bus address 11 and that the printer is at bus address 1. Thus, this line addresses the 3585 to talk, and the printer to listen. The "DATA" command drops the attention line, and allows the transfer to begin. Lines 110 and 120 check the state of the SRQ line on the HP-IB bus. We are assuming here that there are no other devices on the bus which might be asserting the SRQ signal. It is necessary to check the SRQ line without actually doing a serial poll, because the act of doing a serial poll re-configures the bus, interrupting and aborting the plot in progress. This testing of the SRQ line may require a different way of doing things depending upon the actual controller being used. Another potential way of sensing the end of the transfer is to listen in on the transfer, and either look for the EOI signal to be true, or wait for a timeout to occur on the ENTER statement.

```
10      !
20      ! EXAMPLE 7: PLOTTING THE 3585  DISPLAY ON A THINKJET OR ETC.
30      !
40      DISP "Set up display as desired, then press 'CONTINUE'"
50      LOCAL 711                ! Allow local control of 3585
60      PAUSE                    ! Wait for 'CONTINUE'
70      OUTPUT 711;"PP1,CQ,PL"   ! Start printer output with SRQ
80      SEND 7;UNL UNT TALK 11 LISTEN 1 DATA ! Set up bus for transfer
90      DISP "PLOTTING..."
100     REPEAT
110     STATUS 7,7;A             ! Wait for SRQ to happen
120     UNTIL BIT(A,10)
130     DISP "FINISHED"
140     END
```

1 MΩ Flatness

This test checks the frequency response of the 1 MΩ input relative to the flatness of the 50Ω input.

Specification: 20 Hz to 10 MHz = ±.7 dB
10 MHz to 40.1 MHz = ±1.5 dB

Equipment: 50Ω Feed Thru Termination

Procedure:

- a. Set 3585B:

Instrument Preset	
Range	-5 dBm ⁽¹⁾
Reference Level	-6 dBm
Ref Level Track	Off
dB/Div	1 dB
Start Freq	20 Hz
Stop Freq	1 kHz
Res BW	3 Hz ⁽²⁾
Video BW	10 kHz
Sweep Time	30 Sec
Blue (shift)	Cal Off ⁽³⁾
Save	1

- b. Connect 3585B Tracking Generator Output to 3585B 50Ω input.

- c. Adjust 3585B Tracking Generator output for a center of screen displayed trace. Press 3585B Single Sweep twice. Wait for sweep to complete.

- d. Set 3585B:

Store A→B	
A-B	
View B	Off
Input Impedance	1 MΩ

- e. Connect 3585B Tracking Generator output through a 50Ω Feed Thru Termination to the 3585B 1 MΩ input. Press 3585B Single Sweep twice. Wait for sweep to complete.

- f. Using 3585B knob set marker on point of trace with largest absolute deviation from 0.0dB. Compare deviation with spec and record on Performance Test Card.

- g. Set 3585B Range +15 dBm⁽¹⁾. Press 3585B Single Sweep twice. Wait for sweep to complete. Repeat step f.

(1) Use the up/down-arrow keys to change this parameter.
(2) Wait for the 3585 to calibrate (≈10 sec) before proceeding.
(3) Save 4 for the 3585A.

Programming Examples

Example 9: Dumping and restoring traces and states

This example demonstrates the fastest way to dump and restore the B trace and the state. Some of the significant features are: Line 50 opens a channel to the 3585 with FORMAT OFF: this allows quick transfers with no conversions. Lines 370 through 400 show how to read in information from the 3585: Note line 60 which declares all the variables as integers, and that a trace takes 1001 locations and a state takes 49 integers. Lines 500 through 530 show how to re-load the b trace and the state from the arrays. Line 550 displays the trace title along with the trace by using the annotation line feature.

```
10      !
20 Example9:  ! Save/restore states and traces
30      !
40      D85=711
50      ASSIGN @U85 TO D85;FORMAT OFF           ! Open unformatted channel
60      INTEGER Tempint,Btrace(1000),State(48)
70      DIM Title$(50),Filename$(50)
80      OUTPUT D85;"ESDS"                       ! Display following messages
90      OUTPUT D85;"L1CHOOSE THE DESIRED ACTION AND ENTER YOUR CHOICE"
100     OUTPUT D85;"L2ON THE 3585 ENTRY KEYS"
110     OUTPUT D85;"L4RECORD B TRACE AND PRESENT KEY SETTINGS.....1"
120     OUTPUT D85;"L5LOAD B TRACE AND KEY SETTINGS FROM FILE"
130     OUTPUT D85;"L6BACK INTO 3585.....2"
140     REPEAT
150         GOSUB Keyscan                       ! Returns a key in 'F'
160         IF CHR$(F)="1" THEN Recordit       ! Look for 1 or 2 key
170         IF CHR$(F)="2" THEN Recoverit
180     UNTIL False
190         !
200 Recordit:
210     GOSUB Open_file                         ! Ask for user's file name
220     ON ERROR GOTO 330                       ! Check to see if file exists
230     ASSIGN @File TO Filename$              ! Will error if no file
240     OFF ERROR                               ! File exists if we get here
250     ASSIGN @File TO *
260     DISP "IS IT OK TO PURGE FILE ";Filename$;
270     INPUT A$                                ! Get instructions from user
280     IF A$[1,1]<>"Y" AND A$[1,1]<>"y" THEN
290         DISP Filename$;" NOT PURGED"       ! Bail out - don't delete file
300         GOTO Example9
310     END IF
320     PURGE Filename$                         ! Delete file
330     OFF ERROR
340     CREATE BDAT Filename$,1076,2           ! Create file to hold data
350     ASSIGN @File TO Filename$              ! Open the file
360     INPUT "Please enter a title for the B trace (up to 50 characters)",
Title$
370     OUTPUT D85;"BO"                         ! Ask 3585 for the B trace
380     ENTER @U85;Tempint,Btrace(*)           ! Unformatted read of B trace
390     OUTPUT D85;"LO"                         ! Ask 3585 for current state
```

Programming Examples

```

400  ENTER @U85;Tempint,State(*)           ! Unformatted read of state
410  OUTPUT @File;Title$,Btrace(*),State(*) ! Write all data to the file
420  LOCAL D85                             ! Give control back to user
430  DISP "DONE"
440  STOP
450  !
460  Recoverit: !
470  GOSUB Open_file                       ! Ask for name of file
480  ASSIGN @File TO Filename$             ! Open the file
490  ENTER @File;Title$,Btrace(*),State(*) ! Read the data from the file
500  OUTPUT 711;"S2AC0S2BI"               ! Stop sweep & prepare for trace
510  OUTPUT @U85;-1,Btrace(*)             ! Send the B trace to the 3585
520  OUTPUT 711;"LI"                      ! Prepare for state information
530  OUTPUT @U85;-1,State(*)              ! Send state information to
3585
540  OUTPUT D85;"TA0DG"                   ! Display the B trace
550  OUTPUT D85;"AN1LA";Title$           ! Add title to the display
560  LOCAL D85                             ! Return to local control
570  DISP "Finished loading trace: ";Title$
580  STOP
590  !
600  Open_file: !
610  OUTPUT D85;"ESDSL1PLEASE SEE CONTROLLER TO ENTER FILE NAME"
620  INPUT "PLEASE ENTER NAME OF FILE TO USE",Filename$
630  OUTPUT D85;"DG"                      ! Return to graphics display
640  RETURN
650  !
660  Keyscan: !
670  OUTPUT D85;"EE"                      ! Request keypress
680  ENTER D85 USING "#,B";F              ! Wait for & get a key number
690  IF CHR$(F)<"0" OR CHR$(F)>"9" THEN 680 ! Is it a digit key?
700  OUTPUT D85;"EC"                      ! Restore normal operation
710  RETURN
720  !
730  END

```

Programming Examples

Example 10: Plotting under program control

This shows how a plot may be done under program control; it is very similar to example 7, except that the controller listens along with the plotter. Line 110 just reads anything it sees, waiting for a line-feed character. Plots are done as one long string, and only the very last character is a line feed (along with an EOI).

```
10      !
20      ! Example 10: Plot from 3585 to plotter at address 5
30      !
40      DISP "Set up plotter at address 5, then press 'CONTINUE'"
50      PAUSE
60      DISP "Set up 3585 display as desired, then press 'CONTINUE'"
70      PAUSE
80      OUTPUT 711;"PP0,PL"                ! Select plotter & start plot
90      SEND 7;UNL UNT TALK 11 MLA LISTEN 5 DATA ! Address bus
100     DISP "PLOTting..."
110     ENTER 7 USING "/"                  ! Wait for plot completion
120     LOCAL 711                          ! Return control to user
130     DISP "FINISHED"
140     !
150     END
```

Example 11: Limit testing

This example makes use of the limit test feature to test a low pass filter for pass-band ripple and stop-band rejection. In this case, it is assumed that the actual insertion loss is not critical, but that the 0-20 MHz passband ripple must be within ± 5 dB of the nominal loss at 10 MHz. Furthermore, the stop-band must be down at least 45 dB at frequencies above 25 MHz.

The program displays the target limits, and waits for the operator to press some key (other than the blue key or the INSTR PRESET key). It then autoranges the 3585, adjusts the reference level, and measures the filter. If the filter is within its specifications, the 3585 displays the message "LIMIT TEST PASS." If the filter fails, the 3585 beeps, display the message "LIMIT TEST FAIL," and the controller also beeps. In addition, the controller displays a message indicating the number of tests which have been made, and how many of those tests have been failures.

```
10      D85=711
20      ASSIGN @U85 TO D85;FORMAT OFF      ! Open fast channel to 3585
30      INTEGER Up_lim(1000),Lo_lim(1000) ! Allocate integer storage
40      CLEAR D85                          ! Reset 3585 to INSTR PRESET state
50      Up_lim(0)=10000                    ! Set up the upper and lower limits
60      Lo_lim(0)=-10000
70      FOR I=1 TO 500
80          Up_lim(I)=0                    ! Allow +/- 5 dB in passband
90          Lo_lim(I)=-1000
100     NEXT I
110     FOR I=501 TO 550
```

Programming Examples

```

120     Up_lim(I)=0           ! Allow +5 dB in transition
130     Lo_lim(I)=-30000
140     NEXT I
150     FOR I=551 TO 1000
160         Up_lim(I)=-5000   ! Demand -45 dB in stop band
170         Lo_lim(I)=-30000
180     NEXT I
190     OUTPUT D85;"BL8"      ! Load lower limit into reg. 8
200     OUTPUT @U85;-1;Lo_lim(*)
210     OUTPUT D85;"BL9"      ! Load upper limit into reg. 9
220     OUTPUT @U85;-1,Up_lim(*)
230     OUTPUT D85;"LM1,LR8,LV1,AR0" ! Use relative mode & view limit
240     REPEAT
250         OUTPUT D85;"EE,AN1,LA"           PRESS A KEY TO CONTINUE"
260         ENTER D85 USING "#,B";Key_code ! Wait for key press
270         OUTPUT D85;"AN0,EC,LC"          ! Remove message, turn off features
280         OUTPUT D85;"S310MZ"            ! Manual measurement at 10 MHz
290         OUTPUT D85;"AR1"               ! Initiate an autorange
300         REPEAT                          ! Await end of autorange
310             OUTPUT D85;"D6T4"
320             ENTER D85 USING "#,B";Xstat
330             UNTIL BINAND(Xstat,3)<>3
340             OUTPUT D85;"AR0"            ! Get out of autorange
350             OUTPUT D85;"D1T6"          ! Read current amplitude @ 10 MHz
360             ENTER D85;Ref_level
370             OUTPUT D85;"RL";Ref_level+5;"DM" ! Set ref level 5 dB higher
380             OUTPUT D85;"S2"            ! Do a single sweep
390             OUTPUT D85;"CQ,LQ"         ! Enable limit test & SRQs
400             REPEAT
410                 X=SPOLL(D85)           ! Read 3585 status byte
420                 UNTIL BIT(X,6)         ! Has SRQ been requested?
430                 IF BIT(X,3) THEN       ! Is operation complete set?
440                     Pass_count=Pass_count+1 ! Yes; we've made another test
450                     IF BIT(X,4) THEN   ! Was there a failure?
460                         BEEP
470                         Fail_count=Fail_count+1 ! Count failures
480                         PRINT "TEST ";Pass_count;" FAILED: ";Fail_count;" FAILURES SO
490                         FAR"
490                     ELSE
500                         PRINT "TEST ";Pass_count;" PASSED: ";Fail_count;" FAILURES SO
510                         FAR"
510                     END IF
520                 END IF
530             UNTIL 0                      ! Repeat test forever
540         !
550     END

```

Programming Examples

A few comments about the above program are in order. Lines 50 to 220 fill two arrays with the desired upper and lower limits and load them into registers 8 and 9. The limits are calculated assuming that the reference level is 5 dB above the filter's response at 10 MHz.

Since the insertion loss of the filter is not known and the output of the tracking generator is not calibrated, the program operates by allowing the 3585 to autorange at a fixed frequency. The fixed frequency is used because making swept measurements with the tracking generator and autorange enabled drives the autorange circuitry crazy. If the response of the filter is somewhat higher at some frequency other than 10 MHz, the 3585 may indicate an overload. This should not be a problem, because significant amplitude compression does not happen until well over +5 dB, and by then, the filter is out of limits. Overloading can also cause distortion products, but these are usually not significant in network measurements. After the 3585 indicates that autorange has finished, autorange is disabled.

In lines 350 to 370, the measurement at 10 MHz is used to set the reference level: This is done 5 dB above the 10 MHz reading in order to allow the ± 5 dB of passband ripple to be measurable.

In lines 380 through 420, a single sweep is initiated, and the program waits for the sweep to complete. The serial poll register is then checked to make sure that an operation complete interrupt really did occur, and to see whether the limit test failed.

APPENDIX 3-B META MESSAGES BLOCK DIAGRAMMED

DATA MESSAGES. The Data message is the actual information that is sent from a talker to one or more listeners. This action requires the controller to first enter the command mode to set up the talker and listener(s) for the transfer of data. The information is then transferred in the data mode.

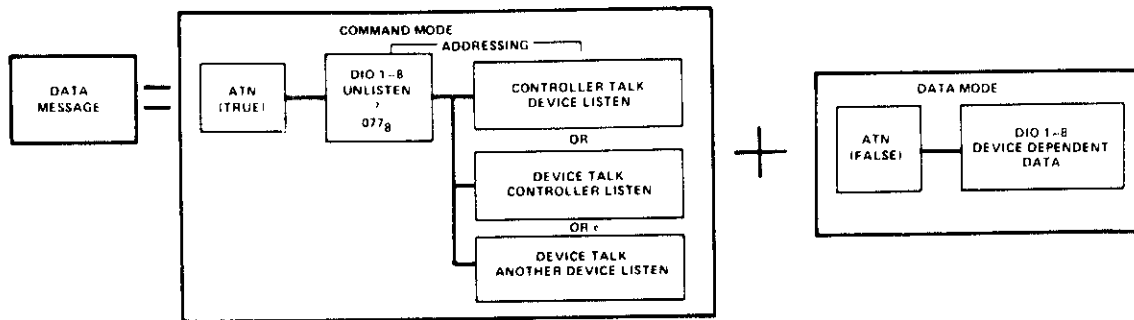

TRIGGER. The Trigger message causes all addressed instruments with this capability to execute some predefined function simultaneously.

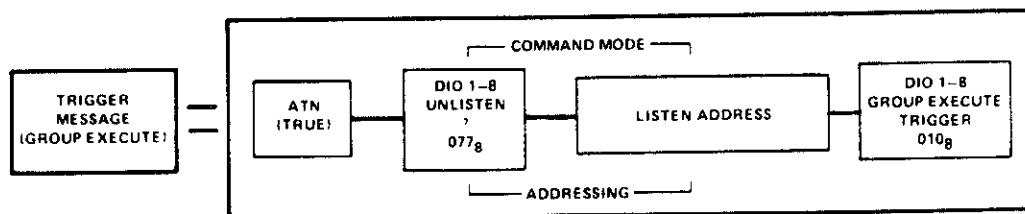

REN MUST BE TRUE BEFORE EXECUTING THE TRIGGER MESSAGE

CLEAR. The Clear message may be implemented for addressed devices or for all devices on the bus capable of responding. In both cases the controller places the bus in the command mode to execute the message.

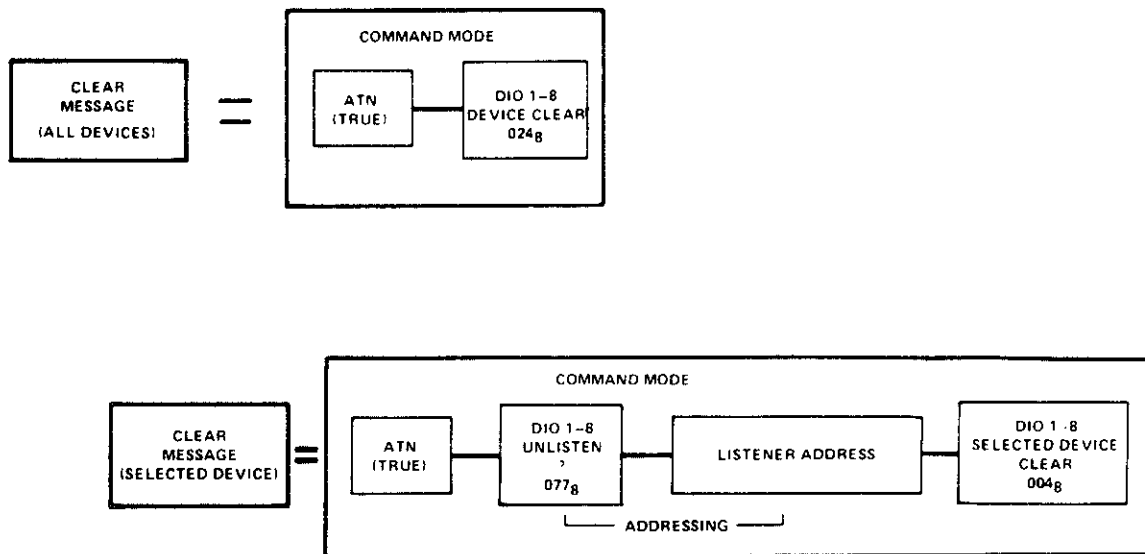

REMOTE. Only the system controller can place the device into the Remote operating condition. To implement the Remote operating message, the controller must set the REN line true. The HP-IB is then in the Remote Enable mode. The controller then sends the listen addresses of those devices that are to be placed in the Remote operating condition. Some instruments have been designed to enter the Remote mode as soon as REN is true.

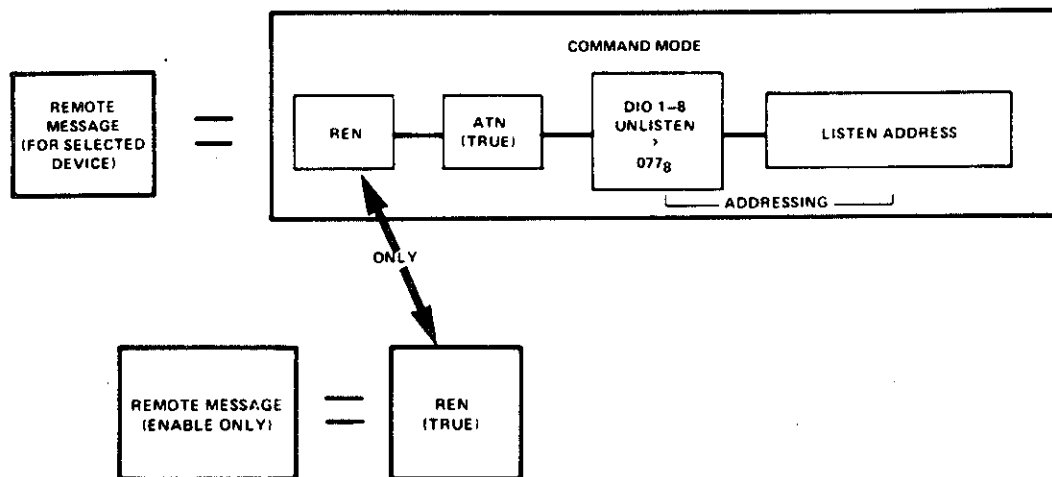

LOCAL. The Local message will remove addressed devices from the Remote operating mode to local (front panel) control. The controller must place the HP-IB into the command mode and address to listen all devices that are to be returned to local. The Local message does not remove the HP-IB from the Remote mode, only the listening devices.

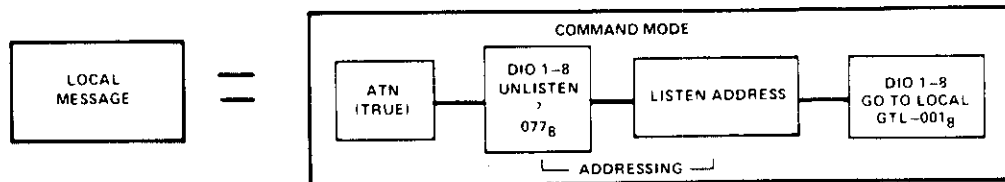

LOCAL LOCKOUT. The Local Lockout message prevents the operator from placing the instrument into local control from the front panel. The controller must be in the command mode to send the Local Lockout message.

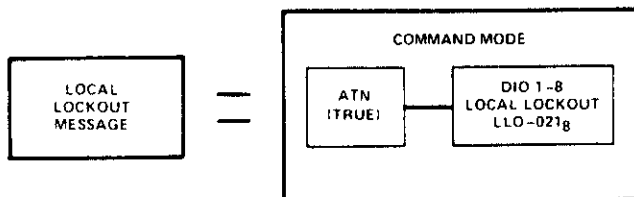

REN MUST BE TRUE BEFORE EXECUTING THE LOCAL LOCKOUT MESSAGE

CLEAR LOCKOUT AND SET LOCAL. This message removes all devices from the Local Lockout mode and causes them to revert to local control. Because the REN line is set false, the HP-IB is in the local mode.

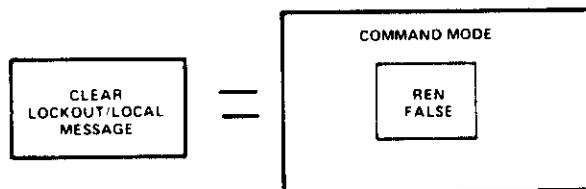

REQUIRE SERVICE. The Require Service message is implemented by a device by setting the SRQ line true. The Require Service message and, therefore, the SRQ line is held true until a poll is conducted by the controller to determine the cause of the request for service, or until the device no longer needs service.

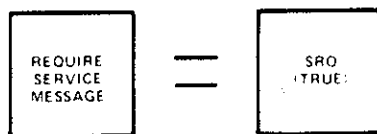

*REFER TO THE STATUS BYTE MESSAGE FOR THE SPECIFICATIONS REQUIRED TO FORCE SRQ FALSE

STATUS BYTE. The Status Byte message represents the operational status of a single instrument during a Serial Poll. A controller usually Serial Polls devices in response to a Request Service message. The controller requests device status from one device at a time. The status information byte (8 bits) sent by the device will tell whether that device needed service and why. A device will stop requesting service upon being Serial Polled, or if it no longer needs service. The controller initiates the message by placing the bus into the command mode, sending the Serial Poll Enable command, and addressing the specific devices to be polled, one at a time. The device then sends its Status Byte and clears the SRQ line provided the cause for the Require Service message is no longer present. The controller then places the bus in the command mode to terminate the message with a Serial Poll Disable command.

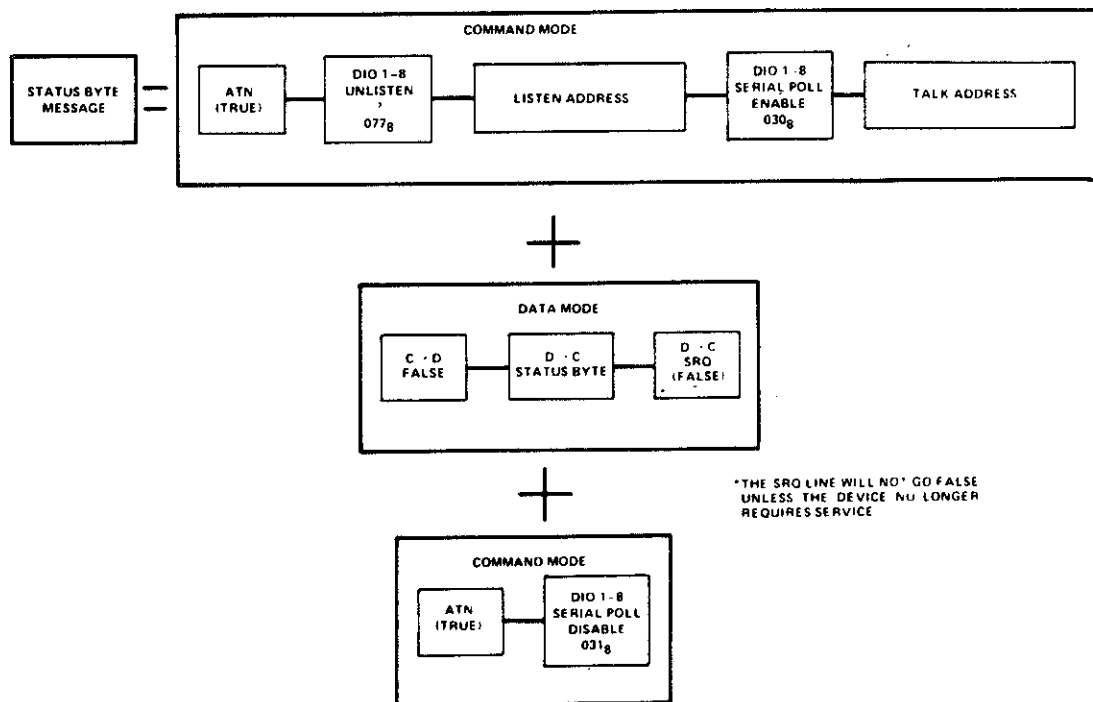

STATUS BIT. The Status Bit message is sent by a device to the controller to indicate its operational status in response to a Parallel Poll. Parallel Polling consists of the controller requesting one bit of status from each device simultaneously. The Parallel Poll may consist of three types of operations: Configuring, Polling, and Unconfiguring. In Configuring, the controller assigns each device a logic level and bit (on the bus data lines) for a poll response. During polling, each device responds on its assigned data line with the appropriate logic level. In Unconfiguring, the controller negates the bit and level assignments for all or selected devices. Several devices may be assigned to the same bit and level, causing their response bits to be logically ORed or ANDED.

NOTE

The 3585 does not respond to Parallel Poll.

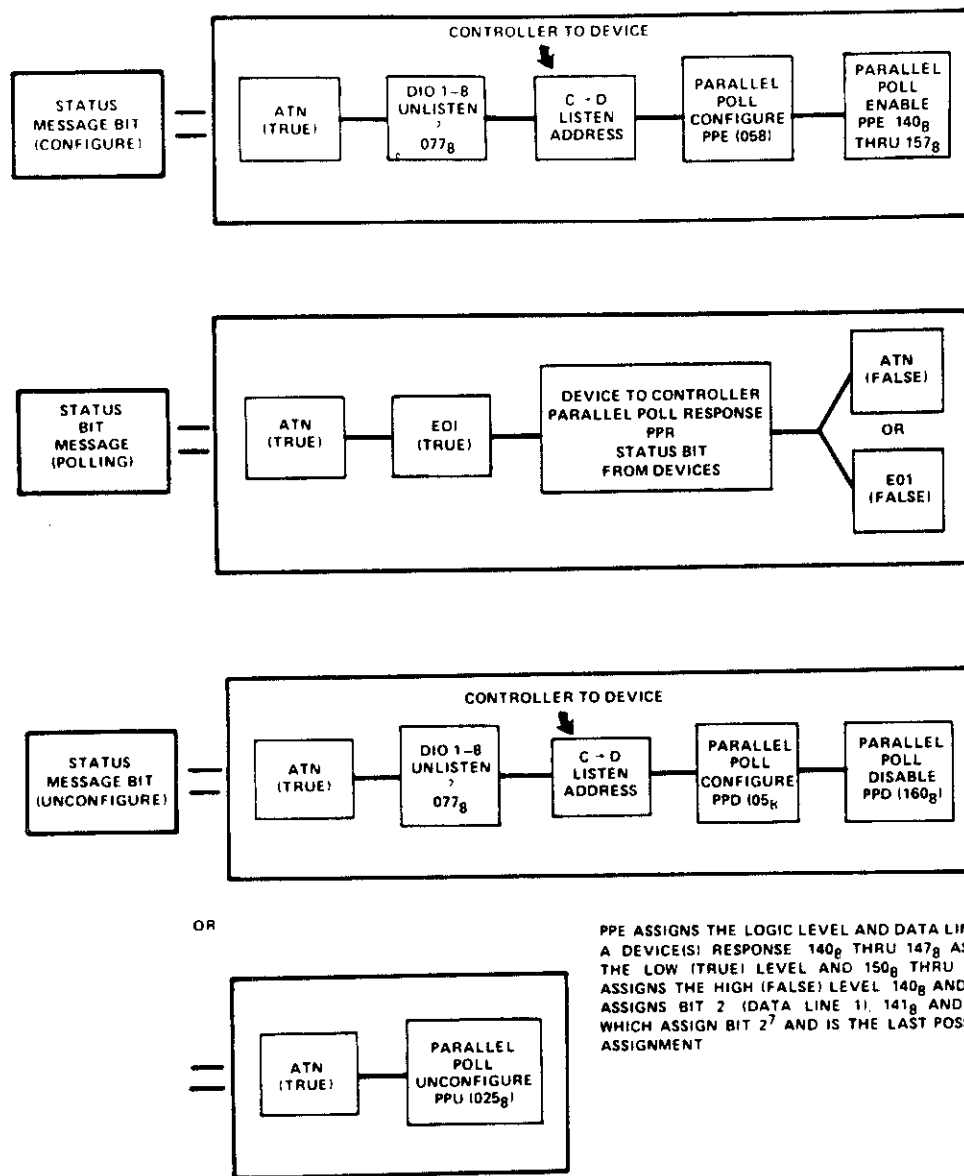

PASS CONTROL. The Pass Control message transfers bus management responsibilities from the active controller to another controller. In order to pass control, the active controller must enter the command mode, send the talk address, and the HP-IB characters for talk control.

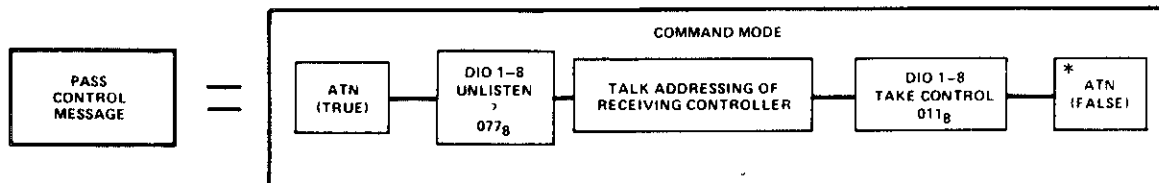

*THE RECEIVING CONTROLLER TAKES CONTROL AT THIS TIME

ABORT. The system Controller implements the Abort Message to regain control of the HP-IB from the active controller.

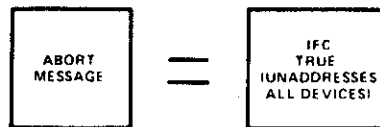

SECTION IV

PERFORMANCE TESTS

INTRODUCTION.

This section contains the procedures for the performance tests which verify that the 3585 will meet its published specifications as listed in Table 1-1. Access to the interior of the instrument is not needed to perform any of the tests.

OPERATIONAL VERIFICATION TESTS OVERVIEW.

The Operational Verification Tests are done manually for the 3585 and are designed to be run with a minimum amount of equipment. A comparison of the required test equipment is presented in Table 4-1. These tests give the user a good indication of the overall condition of the 3585. Using this method of testing a 90% level of confidence that the 3585 meets all its specifications is obtained. The Operational Verification tests take about 3 hours to run.

PERFORMANCE TEST CARD.

A Performance Test Card is provided at the end of this section for your convenience, to record the performance of the 3585 during the Operational Verification Tests. This card can be removed from the manual and used as a permanent record of the incoming inspection or of a routine Performance Test. The Performance Test Card may be reproduced without the written permission of Hewlett-Packard.

CALIBRATION CYCLE.

The 3585 requires verification of its specified performance every 12 months. The Performance Tests can also be used as a part of incoming inspection or after a repair is made to the instrument. The filter screen on the fan should be cleaned each time the instrument's performance is checked.

Operational Verification

OPERATIONAL VERIFICATION

The performance tests listed below comprise the Operational Verification. Operational Verification is a subset of the Performance Tests. Operational Verification may be performed manually or through the use of the semi-automated tests.

List of Tests

- Tracking Generator Flatness
- 1 M Ω Input Noise
- 1 M Ω Flatness
- Cal Offset
- Harmonic Distortion
- Frequency Accuracy
- Source Accuracy Cal
- 50 Ω Flatness*
- Amplitude Linearity*

* Requires that Source Accuracy Cal be performed first.

PERFORMANCE TESTS

Introduction

This section contains the manual procedures for the performance tests which verify that the HP 3585B meets its published specifications. The tests are presented in a sequence to minimize setup reconfiguration of required test equipment and thus minimize overall test time. Performing the full set of performance tests manually requires an extensive amount of time. A semi-automated version, which substantially reduces the required time, is shipped with each instrument.

List of Tests

No equipment required:

- Noise vs Bandwidth
- Tracking Generator Frequency Accuracy
- Residual Spurs
- Low Frequency Response
- Zero Response
- Tracking Generator Flatness

Termination (only) required:

- 1 M Ω Input Noise
- 1 M Ω Input Check
- 1 M Ω Flatness

HP 3335A required:

- Bandwidth Accuracy
- Image 90/10 MHz Spurs
- IF Harmonic Distortion
- Second Order IF IM Distortion
- Conversion Input Spurs
- Marker Accuracy
- Cal Offset
- Compression
- API Spurs
- Step IF Fractional-N Spurs
- Amplitude Linearity

One (or more) pieces of equipment required:

- Local Oscillator Sidebands
- Harmonic Distortion
- Return Loss
- Intermodulation Distortion (A)
- Intermodulation Distortion (B)
- Frequency Accuracy
- Source Accuracy

Requires Source Accuracy Cal. be performed first:

- 50 Ω Flatness
- Range Calibration
- Reference Level Accuracy

Performance Tests

Recommended Test Equipment

Recommended Test Equipment

Table 4-1 lists the equipment required to execute Performance Tests on the HP 3585B. Other equipment may be substituted for the recommended model if it meets or exceeds the listed critical specifications. When substitutions are made, the user may have to modify the performance and adjustment procedures to accommodate the different operating characteristics.

Table 4-1. Recommended Test Equipment

Instrument	Critical Specs.	Recommended Model
Digital Voltmeter	Full scale range: 1 V _{dc} Accuracy: $\pm 0.004\%$ Resolution: 6 digits Input Resistance: 1 M Ω	HP 3455A
Step Attenuator	0-12 dB; 1 dB steps Freq Range: dc to 40 MHz	HP 355C
Step Attenuator	0-120 dB; 10 dB/step Freq Range: dc to 40 MHz	HP 355D (2 each)
Audio Oscillator	Frequency: 1 kHz Distortion: ≤ -90 dB Amplitude: 0.1 V _{rms}	HP 339A
Directional Bridges (50 Ω and 75 Ω)	Frequency: 0.1 to 40 MHz Return Loss: 30 dB Directivity: 40 dB	HP 8721A and HP 8721A w/ Opt. 008
Frequency Counter	Range: 5-10 MHz Resolution: 0.1 Hz Accuracy: ± 1 count, $\pm 5 \times 10^{-10}$ /day	HP 5328B w/ Opt. 010
Frequency Synthesizer	Freq. Range: 200 Hz to 40.1 MHz Amplitude: +10 to -85 dBm Ampl. Acc: ± 0.25 dBm	HP 3335A
Frequency Synthesizer	Frequency: 20 Hz to 21 MHz Amplitude: +10 to -25 dBm Ampl. Acc: ± 0.4 dB	HP 3325A/B
Impedance Matching Network (50-75 Ω Minimum Loss Pad)	Frequency: 0.1 to 40 MHz VSWR: 1.05	HP 11852A (and adapters)
Thermal Converter	Frequency: 0.1 to 60 MHz Input Impedance: 50 Ω Input Voltage: 0.5V Calibration data (HP Loveland, CO div.)	HP11051A w/ Opt. 01 or, Ballantine Model 1395A-0.4 with cable 12577A option 10 Ballantine Labs, P.O. Box 97, Boonton, NJ 07005
50 Ω Feedthru Termination	$\pm 0.1\Omega$, 1W	HP 11048C/Pomona 4119-50
75 Ω Feedthru Termination	$\pm 0.1\Omega$, 1W	HP 11094B
Spectrum Analyzer	20 Hz to 40 MHz	HP 3585A/B
21 MHz Low-Pass Filter		J87-21M50-6138 TTE Inc., 2214 S. Benny Ave, Los Angeles, CA 90064

Table 4-1. Recommended Test Equipment (cont)

Instrument	Critical Specs.	Recommended Model
BNC Tee		P/N 1250-0781
BNC Sleeve	Impedance: 50Ω Coax BNC(m) to BNC(m)	P/N 1250-0216
Synthesized Signal Generator	Amp: 0 dBm Freq range: 0 to 40 MHz Non-related spurious: -90 dBc Power Line: -90 dBc	HP8662A/8663A
BNC sleeve	Impedance: 75Ω Coax BNC (m) to BNC (m)	P/N 1250-1288
Adapter	BNC (f) to dual banana	P/N 1251-2277
100 kΩ termination	100 kΩ to ground	See example in figure below.
Cable	Impedance: 75Ω	P/N 8120-0688

NOTE

Unless otherwise specified, the 3335A reference oscillator input (40/N MHz) should be connected to the 3585 10 MHz reference output. This assures accurate frequency signal from the 3335A.

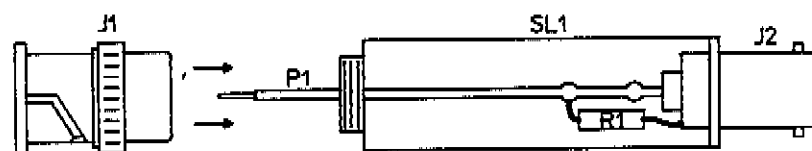

MATERIALS:

ITEM	QTY	DESCRIPTION	PART NBR
J1	1	CONNECTOR BNC MALE	1250-0052
J2	1	CONNECTOR BNC FEMALE	1250-0083
P1	1	PIN	11048-27603
SL1	1	SLEEVE	1531-0246
R1	1	RESISTOR 100K	0757-0465

100 kΩ termination

Performance Tests

Noise vs Bandwidth

Noise vs Bandwidth

This test is used to determine the average noise level in each of the resolution bandwidths.

Equipment: None

Specification: See Table 1-1.

Procedure:

- a. Disconnect all inputs to the 3585B.
- b. Set the 3585B controls for:

Instrument Preset	
Manual Entry	39.123456 MHz
Reference Level	-60 dBm
Res. BW	30 kHz
Video BW	1 Hz

- c. Read the marker amplitude. Take an average of the readings displayed. This average value should be below the test tolerance shown by the specifications listed.
- d. Record the average noise reading for the current Res BW and Ref Level setting on the Performance Test Card.
- e. Press the Res BW key and the down-arrow key to step to the next Res BW.
- f. Repeat steps c through e for each Res BW on Performance Test Card.
- g. Set 3585B:

Reference Level	-45 dBm
Res BW	30 kHz

- h. Repeat steps c thru f for Ref Level -45 dBm.
- j. Set 3585B:

Res BW	30 kHz
Reference Level	-60 dBm

- k. Set 3585B:

Manual Entry	$.10 \times \text{RBW}$ or 10 kHz ⁽¹⁾
------------------------	--

- l. Read the marker amplitude. Take an average of the readings displayed. This average value should be below the test tolerance shown by the specifications listed.
- m. Record the average noise reading on the Performance Test Card.

(1) Whichever is larger.

- n. Press the Res BW key and the down-arrow key to step to the next Res BW.
- o. Repeat steps k thru n for each BW.
- p. Set 3585B:

Blue (shift) Cal Off⁽¹⁾
 Manual Entry 40 Hz
 Res. BW 3 Hz
 Blue (shift) Cal On⁽²⁾
 Noise Level On

- q. Wait until the "(1 Hz)" is displayed (after the displayed amplitude) and record the marker amplitude on the Performance Test Card (40 Hz Noise Level).

Test Limits (dBm)

Res. BW	Manual Entry			
	39 MHz		10×Res BW or 10 kHz ⁽³⁾	
	Ref Level		Freq (kHz)	Ref Level
	-60 dBm	-45 dBm		-60 dBm
30. kHz	-100	-100	300.	-100
10. kHz	-104	-104	100.	-104
3. kHz	-108	-108	30.	-108
1. kHz	-111	-111	10.	-111
300. Hz	-115	-115	10.	-115
100. Hz	-122	-122	10.	-122
30. Hz	-127	-127	10.	-127
10. Hz	-132	-132	10.	-132
3. Hz	-137	-137	10.	-137

Specification at 40 Hz: < -123 dBm (1 Hz)

(1) Save 4 for the 3585A
 (2) Recall 4 for the 3585A
 (3) whichever is larger

Performance Tests

Tracking Generator Frequency Accuracy

Test Card—Noise Vs Bandwidth

Res BW	Manual Entry			
	39 MHz		10×Res BW or 10 kHz ⁽¹⁾	
	Ref Level		Freq (kHz)	Ref Level
	-60 dBm	-45 dBm		-60 dBm
30. kHz			300	
10. kHz			100.	
3. kHz			30.	
1. kHz			10.	
300. Hz			10.	
100. Hz			10.	
30. Hz			10.	
10. Hz			10.	
3. Hz			10.	

Noise Lvl (1Hz) at 40 Hz = _____

Tracking Generator Frequency Accuracy

This test verifies the tracking generator frequency is within ± 1 Hz of the analyzer frequency.

Specification: ± 1 Hz relative to analyzer tuning

Equipment: None

Procedure:

a. Set 3585B:

Blue (shift) 604⁽²⁾
 Instrument Preset
 Center Frequency 10 MHz
 Coupled To Span Off
 Res. BW 30 kHz
 Frequency Span 5 MHz
 Range -20 dBm⁽³⁾
 Manual Entry 10 MHz

b. Turn on the 3585B counter.

c. Read the marker frequency. Let this equal f_2 .

d. Calculate $|10 \text{ MHz} - f_2|$ and record on test card.

(1) whichever is larger.

(2) Recall 604 for the 3585A.

(3) Use up/down-arrow keys to change this parameter.

- e. Turn off the 3585B counter. Press Res Bw and then the down-arrow key to step to the next Res BW.
- f. Repeat steps b through e for each of the bandwidths.

Test Card—Tracking Generator Frequency Accuracy

Res BW	$ (10 \text{ MHz} - f_2) $
30. kHz	
10. kHz	
3. kHz	
1. kHz	
300. Hz	
100 .Hz	
30. Hz	
10. Hz	
3 .Hz	

Residual Spurs

Residual responses (spurs with no input) result from harmonics of the first and second local oscillators mixing to produce a signal at 10.35 MHz (second IF frequency).

Specification: $\leq -120 \text{ dBm}$

Equipment: None

Procedure:

- a. Disconnect all inputs from the 3585B.
- b. Set the 3585B for:

```

Instrument Preset
Res. BW . . . . . 10 Hz
Video BW . . . . . 1 Hz
Auto Range . . . . . Off
Range . . . . . -25 dBm(1)
Reference Level . . . . . -75 dBm
Blue (shift) . . . . . Cal Off(2)
Clear A
    
```

- c. Set the 3585B:

```

Manual Entry . . . . . Spur Freq Hz(3)
    
```

(1) Use up/down-arrow keys to change this parameter.
 (2) Save 4 for the 3858A.
 (3) From the test card

Performance Tests

Low Frequency Responses

- d. Using the 3585B knob look for maximum spur level ± 20 Hz around the spur frequency.

NOTE

If a spur is not present, the reading will be noise-only at approx. -135 dBm.

- e. Verify and record the 3585B marker amplitude. It should be < -120 dBm.

- f. Repeat steps c through e for each spur frequency on test card.

Test Card—Residual Spurs

Spur Freqs (Hz)	3585B Reading
29,475,000	
14,737,500	
35,943,750	
33,356,250	
800,000	
22,263,158	
28,089,474	
27,000,000	
29,632,500	
35,167,500	

Low Frequency Responses

Within the 3585B there are several frequencies which may be picked up by the sensitive analog circuits. These frequencies include:

- Power line (60Hz, 50Hz)
- 5 kHz A/D clock
- 20 kHz (approx) Power Supply Switching Oscillator
- 25 kHz (approx) CRT High Voltage Oscillator
- 100 kHz Fractional-N Clock
- 1 MHz Fractional-N Step Loop Clock
- 10 MHz Internal Reference

These frequencies and their harmonics will be used to verify that all Low Frequency Responses are less than -120 dBm.

Specification: < -120 dBm

Equipment: None

Procedure:

- a. Disconnect all inputs to the 3585B.
- b. Set 3585B:

```

Instrument Preset
Auto Range . . . . . Off
Range . . . . . -25 dBm(1)
Reference Level . . . . . -75 dBm
Res BW . . . . . 3 Hz
Video BW . . . . . 1 Hz
    
```

- c. Set 3585B:

```

Manual Entry . . . . . (2)
CF Step Size . . . . . (2)
Clear A
    
```

- d. The marker is now displaying the amplitude of the frequency chosen in Step c. Record the marker reading on the Performance Test Card and compare the value with spec.
- e. Set the 3585B controls for Manual Entry . . . Step Up. This will increment the marker to the next harmonic component of the frequency chosen in step c.
- f. Take an average reading of the marker amplitude. Record the average value on the Performance Test Card and compare the value with spec.
- g. Repeat steps e and f for each harmonic of the current frequency listed on the Performance Test Card.
- h. Repeat steps c through g for each frequency on the Performance Test Card.
- i. Set 3585B:

```

Instrument Preset
Center Frequency . . . . . 20 kHz
Frequency Span . . . . . 100 Hz
Auto Range . . . . . Off(3)
Range . . . . . -25 dBm(1)
Input Impedance . . . . . 1 MΩ
    
```

(1) Use up/down-arrow keys to change this parameter.
 (2) From the test card.
 (3) Auto Range is turned off by pressing the Range Entry key.

Performance Tests

Low Frequency Responses

- j. Connect a coaxial cable between the Ext Trigger input and the 1 M Ω input of the 3585B. Press "Clear A" and wait for a complete sweep. You are now looking at the Power Supply Switching frequency and possibly the fourth harmonic of the 5 kHz A/D clock.
- k. Turn the knob on the 3585 to move the marker to the most positive point of the displayed response.
- l. Set the 3585B:

Manual Sweep	On
Counter	On
(blue)Mkr Ofs \rightarrow Step	
Counter	Off
Reference Level	-75 dBm
Start Frequency	0 Hz
Stop Frequency	1 MHz
Res BW	10 Hz
Video BW	1 Hz
Input Impedance	50 Ω
Clear A	
Manual Entry	0 Hz

- m. Press Manual Entry and then press the up-arrow key once. This increments the marker to the counter frequency.
- n. Record the Manual Frequency reading on the Performance Test Card under "Power Supply Frequency."
- o. Read the 3585B marker amplitude and enter the value as the first harmonic on the Performance Test Card.
- p. Set the 3585B controls for Manual Entry . . . Step Up. This increments the marker to the next harmonic of the original Manual Entry reading.
- q. Read the marker amplitude. Record the reading on the Performance Test Card and compare the value with spec.
- r. Repeat steps p and q for each harmonic of the current frequency listed on the Performance Test Card.
- s. Set 3585B:

Instrument Preset	
Center Frequency	30 kHz
Frequency Span	15 kHz
Auto Range	Off
Range	-25 dBm ⁽¹⁾
Input Impedance	1 M Ω

(1) Use the u/down-arrow keys to change this parameter.

- t. Disconnect the cable from the Ext Trigger input and hold the BNC connector at the end of the cable up against the face of the CRT. This displays the CRT HV Osc frequency.
- u. Turn the knob to move the marker to the most positive point of the displayed response.
- v. Repeat step l and release the CRT cable.
- u. Repeat steps m through r.

Test Card—Low Frequency Responses

Description	Freq	Harmonics									
		1	2	3	4	5	6	7	8	9	10
Line Freq	50/60 Hz										
A/D Clock	5 kHz										
Frac/N Clock	100 kHz										
Step Loop Clock	1 MHz										
Internal Ref	10 MHz					XXX	XXX	XXX	XXX	XXX	XXX
Power Supply											
CRT Oscillator											

Zero Response

This test measures the amplitude of the local oscillator feedthrough. This response occurs at 0 Hz due to the local oscillator passing directly through the IF section.

Specification: LO Feedthrough < -15 dB Below Range

Equipment: None

Procedure:

- a. Disconnect all inputs to the 3585B.
- b. Set 3585B:
 - Instrument Preset
 - Range 0 dBm⁽¹⁾
 - Manual Entry 0 Hz
- c. Read marker amplitude. The reading should be less than -15 dB.
- d. Record the marker amplitude on the Performance Test Card.

Test Card—Zero Response

3585B Reading = _____ dB

(1) Use the up/down-arrow keys to change this parameter.

Performance Tests
Tracking Generator Flatness

Tracking Generator Flatness

This procedure verifies the amplitude flatness of the tracking generator using the internal calibrator as a reference.

Specification: Tracking Generator Response ± 0.7 dB

Equipment: None

Procedure:

- a. Set 3585B:

Blue (shift) 604⁽¹⁾
Instrument Preset
dB/Div 1 dB
Range -20 dBm⁽²⁾
Start Frequency 100 kHz
Stop Frequency 40.1 MHz
Clear A

- b. Allow a complete sweep to occur.

- c. Set 3585B:

Store A→B
View B Off
Save 1
Instrument Preset
Recall 1
Range 0 dBm⁽²⁾

- d. Connect the Tracking Generator output to the 3585B 50Ω input.
- e. Adjust the Tracking Generator Amplitude control so that the displayed trace is in the middle of the CRT display.
- f. Press "Clear A" and wait for a complete sweep. Turn the A-B function on.
- g. Turn the knob to move the marker to the most negative point on the trace.
- h. Set the 3585B:

Offset On
Enter Offset

- i. Turn the knob to move the marker to the most positive point on the trace. The marker amplitude should read < 1.4 dB. Record the value on the Performance Test Card.

(1) Recall 604 for the 3585A

(2) Use the up/down-arrow keys to change this parameter.

Test Card—Tracking Generator Flatness

Tacking Generator Amplitude Flatness = _____

1 MΩ Input Noise

This test verifies the noise performance of the 1 MΩ input when it is terminated with a 100 kΩ load.

Specification: < -74 & < -86 dB below Range @ 10 kHz and 500 kHz respectively.

Equipment: 100 kΩ termination

Procedure:

- a. Connect 100 kΩ termination to the 3585B 1 MΩ input.
- b. Set 3585B:

```

Instrument Preset
Input Impedance . . . . . 1 MΩ
Res BW . . . . . 1 kHz
Video BW . . . . . 1 Hz
Auto Range . . . . . Off
Range . . . . . -25 dBm(1)
Manual Entry . . . . . 10 kHz
Reference Level . . . . . -75 dBm
    
```

- c. Read the marker amplitude. Subtract the Range from the Marker amplitude and record on the Performance Test Card.
- d. Step to the next range by pressing the Range key and the up arrow key.
- e. Repeat steps c and d through Range 30.
- f. Set 3585B:

```

Manual Entry . . . . . 500 kHz
Range . . . . . -25 dBm(1)
    
```

- g. Repeat steps c and d through range 30.

Test Card—1 MΩ Input Noise

Freq	Range											
	-25	-20	-15	-10	-5	0	5	10	15	20	25	30
10 kHz												
500 kHz												

(1) Use the up/down-arrow keys to change this parameter.

Performance Tests

1 M Ω Input Check

1 M Ω Input Check

This test verifies the accuracy of the 1 M Ω range attenuators.

Specification: < 1 dB amplitude offset from the -10 dB Range.

Equipment: 50 Ω termination

Procedure:

- a. Connect a 50 Ω feedthru termination to the 3585B 1 M Ω input and connect the tracking generator's output to the 50 Ω termination.
- b. Set 3585B:

```
Instrument Preset
Stop Frequency . . . . . 40.1 MHz
Range . . . . . -10 dBm(1)
Reference Level . . . . . -6 dBm
Ref. Level Track . . . . . Off
dB/Div . . . . . 1 dB
Manual Entry . . . . . 10 MHz
Input Impedance . . . . . 1 M $\Omega$ 
Video BW . . . . . 10 Hz
```

- c. Adjust the tracking generator to the center of the display.
- d. Set 3585B:

```
Offset . . . . . On
Enter Offset
Range . . . . . -5 dBm(1)
```

- e. Record the offset amplitude value on the Performance Test Card.
- f. Press Range followed by the up arrow key to step to the next range.
- g. Repeat steps e and f through range +15.

Test Card - 1 M Ω Input Check

Range	Amplitude Offset
-5	
0	
5	
10	
15	

(1) Use the up/down-arrow keys to change this parameter.

1 MΩ Flatness

This test checks the frequency response of the 1 MΩ input relative to the flatness of the 50Ω input.

Specification: 20 Hz to 10 MHz = ±.7 dB
10 MHz to 40.1 MHz = ±1.5 dB

Equipment: 50Ω Feed Thru Termination

Procedure:

- a. Set 3585B:

Instrument Preset	
Range	-5 dBm ⁽¹⁾
Reference Level	-6 dBm
Ref Level Track	Off
dB/Div	1 dB
Start Freq	20 Hz
Stop Freq	1 kHz
Res BW	3 Hz ⁽²⁾
Video BW	10 kHz
Sweep Time	30 Sec
Blue (shift)	Cal Off ⁽³⁾
Save	1

- b. Connect 3585B Tracking Generator Output to 3585B 50Ω input.

- c. Adjust 3585B Tracking Generator output for a center of screen displayed trace. Press 3585B Single Sweep twice. Wait for sweep to complete.

- d. Set 3585B:

Store A→B	
A-B	
View B	Off
Input Impedance	1 MΩ

- e. Connect 3585B Tracking Generator output through a 50Ω Feed Thru Termination to the 3585B 1 MΩ input. Press 3585B Single Sweep twice. Wait for sweep to complete.

- f. Using 3585B knob set marker on point of trace with largest absolute deviation from 0.0dB. Compare deviation with spec and record on Performance Test Card.

- g. Set 3585B Range +15 dBm⁽¹⁾. Press 3585B Single Sweep twice. Wait for sweep to complete. Repeat step f.

(1) Use the up/down-arrow keys to change this parameter.
(2) Wait for the 3585 to calibrate (≈10 sec) before proceeding.
(3) Save 4 for the 3585A.

Performance Tests

1 MΩ Flatness

h. Set the 3585B:

```

Recall . . . . . 1
Blue (shift) . . . . . Cal On(1)
Start Freq . . . . . 1 kHz
Stop Freq . . . . . 100 kHz
Res BW . . . . . 300 Hz(2)
Video BW . . . . . .10 kHz
Sweep Time . . . . . 2 Sec
Blue (shift) . . . . . Cal Off(3)
    
```

i. Repeat steps b through g.

j. Set the 3585B:

```

Recall . . . . . 1
Blue (shift) . . . . . Cal On(1)
Start Freq . . . . . 100 kHz
Stop Freq . . . . . 10 MHz
Res BW . . . . . 3 kHz(2)
Video BW . . . . . 300 Hz
Sweep Time . . . . . 2 Sec
Blue (shift) . . . . . Cal Off(3)
    
```

k. Repeat steps g through g.

l. Set the 3585B:

```

Recall . . . . . 1
Start Freq . . . . . 10 MHz
Stop Freq . . . . . 40.1 MHz
Res BW . . . . . 3 kHz
Video BW . . . . . 300 Hz
Sweep Time . . . . . 2 Sec
    
```

m. Repeat steps b through g.

Test Card—1 MΩ Flatness

Frequency	Max Deviation	
	Range = -5 dBm	Range = +15 dBm
20 Hz → 1 kHz		
1 kHz → 100 kHz		
100 kHz → 10 MHz		
10 MHz → 40.1 MHz		

(1) Recall 4 for the 3585A

(2) Wait for the 3585 to calibrate (≈10 sec) before proceeding.

(3) Save 4 for the 3585A.

Bandwidth Accuracy

This test verifies that the 3585 meets its 3 dB Bandwidth and Shape Factor specifications.

Specification: 3 dB Bandwidth: $\pm 20\%$ of BW setting at the 3 dB points

Selectivity (Shape Factor): $< 11:1$

Equipment: 3335A

Procedure:

NOTE

Initially, this test checks the 3 dB points of each Res BW; therefore, ignore the values in parenthesis until instructed otherwise.

a. Connect the 3335A output to the 3585B 50 Ω input.

b. Set the 3335A:

Frequency 10 MHz
Amplitude -25 dBm

c. Set the 3585B:

Instrument Preset
Center Frequency 10 MHz
Reference Level -24.5 dBm
dB/Div 1 dB
Res BW Hold On
Auto Range Off⁽¹⁾

d. Set the 3585B:

Res BW 3 Hz⁽²⁾
Frequency Span 10 Hz⁽²⁾
Sweep Time 15 sec⁽²⁾

e. Allow one complete sweep to occur. Turn the knob to move the marker to the most positive point on the trace (use the marker amplitude readout to judge).

f. Set the 3585B:

Offset On
Enter Offset

g. Turn the knob to move the marker down the left side of the trace until a marker amplitude of $-3.00 \text{ dB} \pm 0.03 \text{ dB}$ ($-60.0 \text{ dB} \pm 0.4 \text{ dB}$) is obtained.

(1) Auto Range is turned off by pressing the Range Entry key.

(2) From the test card.

Performance Tests

Bandwidth Accuracy

- h. Press "Enter Offset."
- i. Turn the knob to move the marker to the right side of the trace until a reading of 0.00 dB ± 0.03 dB (0.0 dB ± 0.4 dB) is obtained.
- j. Read the value displayed as "Offset." This value represents the frequency span between the 3 dB (60 dB) points of the IF filter. The value obtained should be within $\pm 20\%$ of the chosen bandwidth.
- k. Read the Offset frequency value and record it in the "BW Meas." column of the 3 dB (60 dB) section, across from the appropriate bandwidth, on the Performance Test Card.
- l. Set the 3585B:

Offset Off

- m. Repeat steps d through k for all the 3 dB (60 dB) bandwidth measurements.
- n. Now make the 60 dB measurements. Use the values in parenthesis for the remainder of the bandwidth tests.
- o. Set the 3585B:

dB/Div 10 dB
Frequency Span 100 Hz⁽¹⁾
Res BW 3 Hz⁽¹⁾
Sweep Time 23 sec⁽¹⁾

- p. Repeat steps e through l.
- q. Repeat steps d through m for the remaining 60 dB measurements on the Performance Test Card.
- r. Calculate and enter the Shape Factor for each line of the Performance Test Card where:

$$\text{Shape Factor} = (60 \text{ dB BW}) \div (3 \text{ dB BW}).$$

(1) From the test card.

Test Card—Bandwidth Accuracy

Res Bw	3 dB Bandwidth			60 dB bandwidth			Shape Factor
	Freq Span	Sweep Time ⁽¹⁾	BW Meas.	Test Limit	Freq Span	Sweep Time ⁽¹⁾	
3 Hz	10 Hz	15		3 Hz ±.6 Hz	100 Hz	23	
10 Hz	30 Hz	8		10 Hz ±2 Hz	200 Hz	15	
30 Hz	100 Hz	7		30 Hz ±6 Hz	500 Hz	10	
100 Hz	200 Hz	6		100 Hz±20 Hz	2 kHz	8	
300 Hz	1 kHz	6		300 Hz±60 Hz	5 kHz	5	
1 kHz	2 kHz	6		1 kHz±200 Hz	20 kHz	5	
3 kHz	10 kHz	6		3 kHz±600 Hz	50 kHz	5	
10 kHz	20 kHz	6		10 kHz±3 kHz	100 kHz	5	
30 kHz	100 kHz	6		30 kHz±6kHz	500 kHz	5	

Image 90/10 MHz Spurs

This test measures the image rejection of the first IF at 79.65 MHz and the second IF at 9.65 MHz. Sidebands at offsets of 10 MHz on the second LO (90 MHz) are also measured.

Specification: < -80 dB below signal

Equipment: 3335A

Procedure:

- a. Connect the 3335A signal output to the 3585B's 50Ω input.
- b. Set 3585B:

```

Instrument Preset
Res. BW . . . . . 30 Hz
Video BW . . . . . 1 Hz
Range . . . . . 0 dBm(2)
Reference Level . . . . . -10 dBm
Stop Frequency . . . . . 40.1 MHz
Clear A
    
```

- c. Set the 3335A:

```

Amplitude . . . . . +10 dBm(3)
Frequency . . . . .
    
```

(1) In seconds.
 (2) Use up/down-arrow keys to change this parameter.
 (3) From test card.

Performance Tests

IF Harmonic Distortion

d. Set the 3585B:

Manual Entry Spur Freq⁽¹⁾

e. Read the 3585B marker amplitude.

f. Calculate the marker amplitude minus the signal level (+10), for each pair, and record on the Performance Test Card.

g. Repeat steps c through e for each line of the Performance Test Card.

Test Card—Image 90/10 MHz Spurious

3335A freq (MHz)	3585B Spur Freq (MHz)	Spur Level
30.75	10.05	
40.05	39.35	
20.05	10.05	
30.05	10.05	
20.75	10.05	
30.05	40.05	

IF Harmonic Distortion

This procedure measures second and third harmonic distortion produced in the third IF (350 kHz) with a full-scale input.

Specification: < -80 dB below signal

Equipment: 3335A

Procedure:

a. Connect the 3335A 50Ω output to 3585B 50Ω input.

b. Set 3585B:

Instrument Preset
 Range 0 dBm⁽²⁾
 Ref. Level Trk Off
 Res. BW 10 Hz
 Video BW 1 Hz
 Blue (shift) Cal Off⁽³⁾
 Stop Frequency 40.1 MHz
 Clear A

(1) From the test card.

(2) Use the up/down-arrow keys to change this parameter.

(3) Save 4 for the 3585A.

c. Set the 3335A controls for:

Frequency 33,445,566.7 Hz
Amplitude 0 dBm
Amplitude Incr 0.1 dBm

d. Set the 3585B controls for:

Manual Entry 33,445,566.7 Hz

e. Adjust 3335A amplitude using the 3335A Incr key until 3585B amplitude is 0.0 dBm.

f. Set the 3585B controls for:

Ref Level -40 dBm
Manual Entry 33,270,567 Hz

g. Using 3585B knob find maximum harmonic level \pm 20 Hz around the manual entry frequency.

h. Read and record the 3585B amplitude as the second harmonic.

i. Set the 3585B controls for:

Manual Entry 33,212,233 Hz

j. Using 3585B knob find maximum harmonic level \pm 20 Hz around the manual entry frequency.

k. Read and record the 3585B amplitude as the third Harmonic.

Test Card—IF Harmonic Distortion

Order	3585B Reading
2nd	
3rd	

Performance Tests

Second-Order IF IM Distortion

Second-Order IF IM Distortion

This test measures intermodulation distortion in both the second and third IFs when two tones (sum and difference product of preceding mixer) produce a difference product whose frequency is one of the IF frequencies (10.35 MHz and 350 kHz).

Specification: < -80 dB below signal

Equipment: 3335A

Procedure:

- a. Connect the 3335A 50 Ω output to the 3585B 50 Ω input.
- b. Set 3585B:

Instrument Preset	
Res BW Hold	On
Res. BW	1 kHz
Range	0 dBm ⁽¹⁾
Ref Level Trk	Off
Ref Level	0 dBm
Stop Frequency	0.2 MHz
Video BW	100 Hz

- c. Set 3335A:

Frequency	175 kHz
Amplitude	0 dBm

- d. Set the 3585B:

Clear A	
Single Sweep	On

- e. After a sweep is completed, turn the Display Line on and use the knob to sight the highest point between 10 kHz and 160 kHz. Set the Marker ON, then use the knob to move the marker to the highest point between 10 kHz and 100 kHz.

- f. Set 3585B:

Manual Sweep	On
Res BW	10 Hz
Video BW	1 Hz

- g. Read the marker amplitude and record on the Performance Test Card for an input frequency of 175 kHz.

(1) Use the up/down-arrow keys to change this parameter

h. Set 3585B:

Res. BW 3 kHz
 Stop Frequency 6 MHz
 Video BW 1 kHz

i. Set 3335A:

Frequency 5.175 MHz
 Amplitude 0 dBm

j. Set the 3585B:

Single Sweep On

k. After a full sweep is complete, turn the Display Line on and use the knob to sight the highest point between 295 kHz and 4.795 MHz. Set the Marker On and use the knob to move the marker to the highest point between 295 kHz and 4.795 MHz.

l. Set 3585B:

Manual Sweep On
 Res BW 10 Hz
 Video BW 1 Hz

m. Read the marker amplitude and record on the Performance Test Card for an input frequency of 5.175 MHz.

Test Card – Second-Order IM Distortion

Input Freq	3585B Reading
175 kHz	
5.175 MHz	

Performance Tests

Conversion/Input Spurs

Conversion/Input Spurs

This test verifies conversion spur performance when mixing products of the first LO (harmonics of the first LO \pm input frequency) are converted to a 10.35 MHz IF signal after mixing with harmonics of the second LO at 90 MHz.

Specification: < -80 dB below signal

Equipment: 3335A

Procedure:

- a. Connect the 3335A's 50 Ω output to the 3585B's 50 Ω input.
- b. Set the 3585B:

Instrument Preset	
Res. BW	10 Hz
Video BW	1 Hz
Range	-10 dBm ⁽¹⁾
Reference Level	-50 dBm
Blue (shift)	Cal Off ⁽²⁾

- c. Set the 3335A:

Amplitude	0 dBm
Frequency	(Source Freq) ⁽³⁾

- d. Set the 3585B:

Manual Entry	(Tuned Freq) ⁽³⁾
Clear A	

- e. Using the 3585B knob tune to the maximum point of the spur which will be located within ± 20 Hz of the tune frequency.

NOTE

If the spur is below -100 dBm a maximum point may be hard to find. If in tuning through ± 20 Hz a maximum point is not found the spur is definitely below spec.

- f. Read and record 3585B amplitude on the Performance Test Card.
- g. Repeat steps c through f for each Source/Tune frequency combination on test card.

(1) Use the up/down-arrow keys to change this parameter.
(2) Save 4 for the 3585A.
(3) From the test card.

Test Card – Conversion/Input Spurs

Source Frequency (Hz)	Tune Frequency (Hz)	3585B Reading
34,750,000	34,550,000	
12,250,000	12,116,666	
19,750,000	19,600,000	
34,750,000	34,683,333	
19,750,000	19,675,000	
12,250,000	12,170,000	
19,750,000	19,630,000	
34,750,000	34,670,000	
15,464,286	15,347,619	
25,750,000	25,666,666	

Marker Accuracy

This test verifies that the 3585B meets its marker accuracy specification.

Specification: $\pm 0.2\%$ of Frequency Span \pm RBW

Equipment: 3335A

Procedure:

- a. Connect the 3335A 50 Ω output to the 3585B 50 Ω input.
- b. Set 3585B:

```

Instrument Preset
Res BW . . . . . 1 kHz
Range . . . . . 0 dBm(1)
Frequency Span . . . . . 10 MHz
dB/Div . . . . . 1 dB
    
```

- c. Set 3335A:

```

Frequency . . . . . 20.00 MHz
Amplitude . . . . . 0 dBm
    
```

- d. Press the Single Sweep key twice. When sweeping is complete, select marker Peak Search.⁽²⁾
- e. The marker frequency on the 3585B should be between 19.98 MHz and 20.02 MHz.
- f. Record the marker frequency on the Performance Test Card

(1) Use the up/down-arrow keys to change this parameter.
 (2) For the 3585A, use the knob to move the marker to the peak.

Performance Tests

Cal Offset Test

Test Card – Marker Accuracy

With a 20 MHz signal and a span of 10 MHz, marker accuracy meets spec if it is between 19.98 MHz and 20.02 MHz. A Res BW of 1 kHz does not have a significant effect on the spec.

3335A Freq (MHz)	3585B Marker Freq
20.00	

Cal Offset Test

This test is a check of the amplitude and frequency offsets within the 3585B when the calibration system is turned off. Its purpose is to check the adjustment of the 3585B IF section for large errors which the calibration system may mask. A failure in this test indicates a need to adjust the IF section.

Specification:

Res BW	Freq. Span	Freq. Test Limit	Ampl. Test Limit
30 kHz	50 kHz	± 3.5 kHz	± 5.0 dB
10 kHz	20 kHz	± 3.5 kHz	± 5.0 dB
3 kHz	5 kHz	± 3.5 kHz	± 5.0 dB
1 kHz	2 kHz	± 3.0 kHz	± 5.0 dB
300 Hz	500 Hz	± 900 Hz	± 5.0 dB
100 Hz	200 Hz	± 300 Hz	± 5.0 dB
30 Hz	50 Hz	± 90 Hz	± 5.0 dB
10 Hz	20 Hz	± 30 Hz	± 5.0 dB
3 Hz	7 Hz	± 15 Hz	± 5.0 dB

Equipment: 3335A

Procedure:

a. Set 3335A:

Frequency 10 MHz
Amplitude -25 dBm

b. Connect 3335A 50Ω output to the 3585B 50Ω input.

c. Set 3585B:

Blue (shift) 602⁽¹⁾
Instrument Preset

(1) Recall 602 on the 3585A

d. Set the 3585B:

Res BW Hold On
 Center Frequency 10 MHz⁽¹⁾
 Frequency Span (1)
 Res BW (1)
 dB/Div 1 dB
 Reference Level -22 dBm⁽¹⁾
 Sweep Time (1)
 Offset On
 Enter Offset

e. Turn the knob to move the marker (right) to an amplitude offset $-3.00 \text{ dB} \pm .05 \text{ dB}$. Make a note of the offset frequency. This is referred to later as Offset Frequency (A).

f. Set the 3585B:

Save 1
 Blue (shift) 601⁽²⁾
 Instrument Preset

g. Set the 3585B:

Recall 1

h. Turn the knob to move the marker to the peak amplitude on the trace. Record the marker amplitude readout in the Performance Test Card under Internal Offset Amplitude.

i. Add -3.00 dB to the marker amplitude found in step h. Turn the knob to move the marker to an amplitude on the right side of the peak which is $-3.00 \text{ dB} +$ amplitude found in step h ($\pm .05 \text{ dB}$). Note the offset frequency and subtract Offset Frequency (A) from this value. Record this result under the Internal Offset Frequency on the Performance Test Card.

k. Repeat step c to j for each of the Res BW entries on the Performance Test Card.

(1) From the test card.

(2) Recall 601 for the 3585A.

Performance Tests

Compression

Test Card—Cal Offset

Res BW	Freq. Span	Sweep Time	Internal Offset Freq.	Internal Offset Ampl.
30 kHz	50 kHz	0.2 sec		
10 kHz	20 kHz	0.2 sec		
3 kHz	5 kHz	0.2 sec		
1 kHz	2 kHz	0.2 sec		
300 Hz	500 Hz	1.6 sec		
100 Hz	200 Hz	3.2 sec		
30 Hz	50 Hz	5.0 sec		
10 Hz	20 Hz	15 sec		
3 Hz	7 Hz	20 sec		

Compression

This test verifies that the 3585B meets the amplitude accuracy spec with an input signal that is 12 dB above the input range.

Specification: dB Band \leq .5 dB

Equipment: 3335A

Procedure:

a. Connect 3335A 50 Ω output to 3585B 50 Ω input.

b. Set 3335A:

Frequency 1953 Hz
Amplitude Incr 1 dBm
Amplitude 12.3 dBm

c. Set 3585B:

Instrument Preset
Range 0 dBm⁽¹⁾
Reference Level 10 dBm
Manual Entry 1953 Hz
Res BW300 Hz
Blue (shift) Cal Off⁽²⁾

d. Read and record the 3585B Marker Amplitude. Record difference between 3335A setting and Marker Amplitude on Performance Test Card.

(1) Use the up/down-arrow keys to change this parameter.

(2) Save 4 for the 3585A.

e. Set 3335A:

Incr Down

f. Repeat steps d and e for each 3335A amplitude on Performance Test Card.

g. Find the difference between the most-positive and most-negative of the recorded differences for this Res BW. Record this difference as dB Band. The dB Band should be $\leq .5$ dB.

h. Set 3335:

Amplitude 12.3 dBm

i. Set 3585B:

Res BW 3 Hz
Blue (shift) Cal On⁽¹⁾

j. Wait for the completion of the calibration.

k. Set the 3585B:

Blue (shift) Cal Off⁽²⁾

l. Repeat steps d through g.

(1) Recall 4 for the 3585A.
(2) Save 4 for the 3585A.

Performance Tests

Compression

Test Card—Compression

3335A (dBm)	Res BW = 300 Hz		Res BW = 3 Hz	
	3585B Marker	3335A-3585B	3585B Marker	3335A-3585B
12.3				
11.3				
10.3				
9.3				
8.3				
7.3				
6.3				
5.3				
4.3				
3.3				
2.3				
1.3				
0.3				
-0.7				
-1.7				
-2.7				
-3.7				
-4.7				
-5.7				
-6.7				

Res BW = 300 Hz

dB Band = _____

Res BW = 3 Hz

dB Band = _____

API Spurs

These tests verify the spur performance of the Fractional-N portion of the LO frequency synthesis section.

Specification: < -80 dB below signal

Equipment: 3335A

Procedure:

a. Connect the 3335A's 50Ω output to the 3585B's 50Ω input.

b. Set the 3585B:

Blue (shift) 601⁽¹⁾
Instrument Preset
Stop Freq 40.1 MHz
Res BW 3 Hz
Video BW 1 Hz
Range -10 dBm⁽²⁾

c. Set the 3335A:

Amplitude 0 dBm
Frequency Spur Freq (MHz)⁽³⁾
Sweep Width 30 Hz

d. Set the 3585B:

Manual Entry Spur Freq (MHz)⁽³⁾

e. Set the 3335:

Frequency Incr Offset freq (kHz)⁽³⁾
Incr Up once
Go To Start Freq
Manual Sweep On⁽⁴⁾

f. Set the 3585B:

Clear A

g. Using the 3335A knob, manually sweep through the sweep width to find the maximum spur level. Subtract the 3 Hz internal amplitude offset (found in Cal Offset procedure) from this value and record this value as the 3585B reading.

h. Repeat steps c through g for each Spur/Offset freq combination on the test card.

(1) Recall 601 for the 3585A.

(2) Use the up/down-arrow keys to change this parameter.

(3) From the test card.

(4) Do not confuse the 3335A [Manual] Sweep key with the Manual Tune (on/off) key.

Performance Tests

API Spurs

Test Card—API Spurs

Spur Freq (MHz)	Offset Freq (kHz)	3585B Reading
0.4001	2.0	
0.40019	3.8	
9.4001	2.0	
9.40019	3.8	
18.4001	2.0	
18.40019	3.8	
27.4001	2.0	
27.40019	3.8	
36.4001	2.0	
36.40019	3.8	

Step IF Fractional-N Spurs

This test verifies spur levels which result from an interaction of two of the frequency synthesizers required to generate the LO signal. One of these is the Fractional-N synthesizer and the other is the step loop synthesizer.

Specification: < -80 dB below signal

Equipment: 3335A

Procedure:

a. Connect 3335A's 50Ω output to 3585B's 50Ω input.

b. Set 3585B:

Blue (shift) 601⁽¹⁾
Instrument Preset
Res BW 3 Hz
Video BW 1 Hz
Stop Frequency 40.1 MHz
Range -10 dBm⁽²⁾

c. Set 3335A:

Amplitude 0 dBm
Frequency Spur Freq⁽³⁾
Sweep Width 30 Hz

d. Set 3585B:

Manual Entry Spur Freq⁽³⁾

e. Set 3335A:

Frequency Incr 10 kHz
Incr Down once
Go To Start Freq
Manual Sweep On⁽⁴⁾

f. Set the 3585B:

Clear A

g. Using the 3335A knob manually sweep through the sweep width to find the maximum spur level. Subtract the 3 Hz internal amplitude offset (found in Cal Offset procedure) from this value and record this value as the 3585B reading.

(1) Recall 601 for the 3585A.

(2) Use the up/down-arrow keys to change this parameter.

(3) From the test card.

(4) Do not confuse the 3335A [Manual] Sweep key with the Manual Tune (on/off) key.

Performance Tests

Step IF Fractional-N Spurs

- h. Repeat steps c through g for each spur frequency on test card.

Test Card—Step IF Fractional-N Spur

Spur Freq (Hz)	3585B Reading
3,450,500	
8,050,500	
11,650,500	
16,050,500	
20,450,500	
27,450,500	
31,650,500	
35,850,500	
40,050,500	

Local Oscillator Sidebands

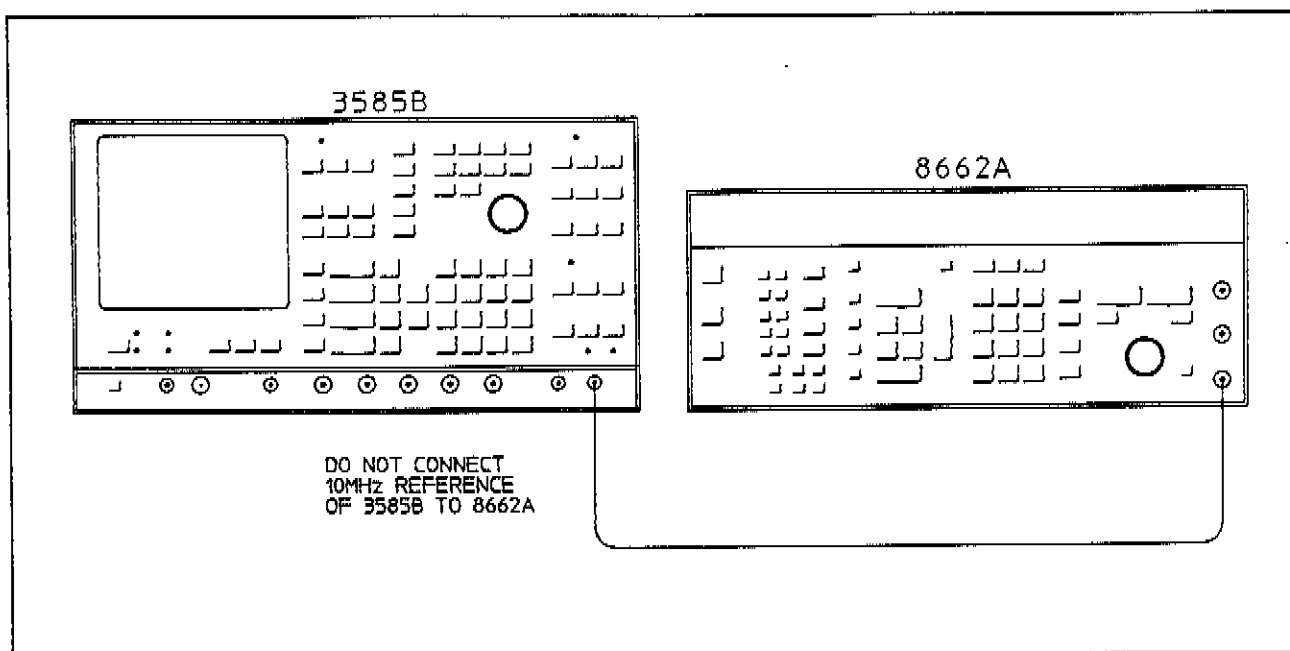

Figure 4-1.

This test measures the LO sidebands caused by internal frequencies that phase modulate the Local Oscillator and appear as input spurs.

Specification: < -80 dB below signal

Equipment: HP 8662A or 8663A

Procedure:

- a. Connect the 8662A RF output to the 3585B's 50Ω input. See Figure 4-1.

NOTE

The 8662A should be phase-locked to its own internal oven; its reference input should not be connected to the 3585B reference output.

- b. Set the 8662A:

Frequency	10 MHz
Amplitude	0 dBm

- c. Set 3585B:

Instrument Preset	
Center Frequency 10 MHz
Counter On

Performance Tests

Local Oscillator Sidebands

- d. When the counter reading is stable set 3585B:

```
(blue ) Mrk Ofs→ Step
Manual Entry . . . . . 0 Hz
Manual Entry . . . . . Step Up
Counter . . . . . Off
Offset . . . . . On
Enter Offset
Reference Level . . . . . -50 dBm
Res BW . . . . . 3 Hz
Video BW . . . . . 1 Hz
Save . . . . . 1
```

- e. Set 3585B controls for a CF Step Size equal to one of the frequencies listed on the Performance Test Card.
- f. Set 3585B controls for Manual Entry – Step Down. This puts the marker one CF Step Size lower in frequency.
- g. Take an average reading of the marker amplitude. Enter this value on the Performance Test Card under sideband harmonic –1 and compare to spec.
- h. Repeat steps f and g four more times for sideband harmonics –2 through –5.
- i. Press the Step Up key six times. This puts the marker on the first upper sideband frequency (+1).
- j. Take an average reading of the marker amplitude. Enter this value on the Performance Test Card under sideband harmonic +1 and compare to spec.
- k. Press the Step Up key on the 3585B. This puts the marker one CF Step Size higher in frequency.
- l. Repeat steps j and k four more times for sideband harmonics +2 through +5.
- m. Set the 3585B controls for Recall 1. This returns you to the original Center Frequency.
- n. Repeat steps e through m until all the frequencies on the Test have been tested.
- o. Repeat steps b through n with the 8662A set for 39 MHz.

Test Card—Local Oscillator Sidebands

Source frequency = 10 MHz:

Frequency	Sideband Harmonics									
	-5	-4	-3	-2	-1	1	2	3	4	5
50/60 Hz ⁽¹⁾										
5 kHz										
100 kHz										
1 MHz										
Power Supply ⁽²⁾										
CRT Oscillator ⁽²⁾										

Source frequency = 39 MHz:

Frequency	Sideband Harmonics									
	-5	-4	-3	-2	-1	1	2	3	4	5
50/60 Hz ⁽¹⁾										
5 kHz										
100 kHz										
1 MHz										
Power Supply ⁽²⁾										
CRT Oscillator ⁽²⁾										

Power Supply _____ Hz CRT Oscillator _____ Hz

- (1) Use the power line frequency of the unit under test.
 (2) Use the CRT oscillator and power supply frequency readings found in the Low Frequency Response test. Record these frequencies on the Performance Test Card.

Harmonic Distortion

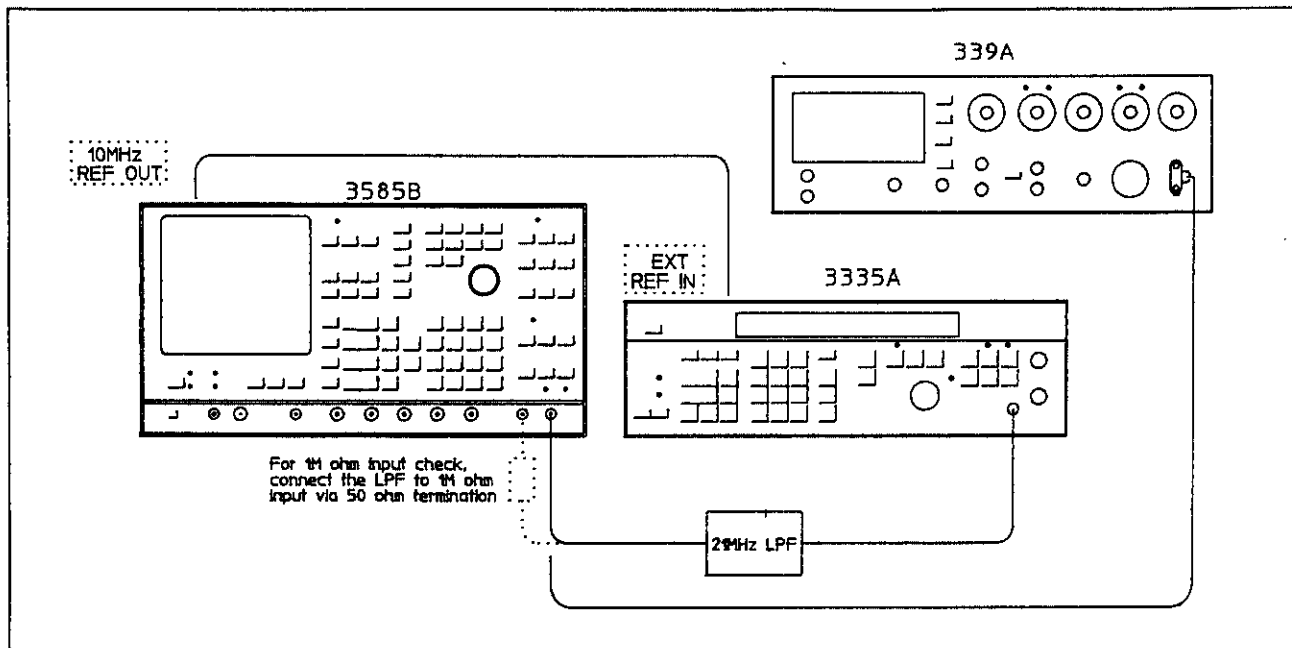

Figure 4-2.

This test verifies that the harmonic distortion produced by the 3585B is at least 80 dB below signal. The filter used in this test removes the harmonic distortion of the source. This leaves only the internally-generated harmonic distortion of the 3585B.

Specification: < -80 dB below signal (-70 dB for 1 MΩ input)

Equipment: 3335A, 339A, 21 MHz LPF, 50Ω termination

Procedure:

High Frequency (50Ω)

- a. Connect the 3335A's 50Ω output to the 21 MHz LPF. Connect the LPF's output to the 3585B's 50Ω input. See Figure 4-2.
- b. Set 3585B:

Instrument Preset	
Blue (shift)	Cal Off ⁽¹⁾
Stop Freq	40.1 MHz
Res BW	30 Hz
Video BW	1 Hz
Range	-15 dBm ⁽²⁾
Reference Level	-15 dBm

(1) Save 4 for the 3585A.

(2) Use the up/down-arrow keys to change this parameter.

c. Set the 3335A:

Frequency 13.31 MHz
Amplitude -15 dBm
Amplitude Incr 0.1 dBm

d. Set the 3585B:

Manual Entry 13.31 MHz⁽¹⁾
Center Freq Step Size 13.31 MHz⁽¹⁾
Blue (shift) Cal On⁽²⁾
(wait for complete calibration)
Blue (shift) Cal Off⁽³⁾

e. Adjust 3335A amplitude using Incr until 3585B marker amplitude is -15 dBm.

f. Set the 3585B:

Offset On
Enter Offset

g. Set 3585B:

Manual Entry
Step Up

h. Read marker amplitude and record 2nd harmonic on Performance test card.

i. Repeat step g and h for the 3rd harmonics.

j. Repeat steps c through i with a frequency of 20.01 MHz instead of 13.01 MHz.

NOTE

There is no 3rd harmonic of 20.01 MHz.

High Frequency (1 M Ω)

j. Connect the 3335A 50 Ω output to the 21 MHz filter input. Connect the filter output to a 50 Ω feedthru termination and the termination's output to the 3585B 1 M Ω input.

k. Repeat steps b through j with the 3585B's Input Impedance set for 1 M Ω .

Low Frequency (50 Ω)

l. Connect the 339A output to the 50 Ω input of the 3585B's 50 Ω input.

(1) From the test card.
(2) Recall 4 for the 3585A.
(3) Save 4 for the 3585A.

Performance Tests

Harmonic Distortion

m. Set 339A:

Frequency 6.4 kHz⁽¹⁾
Output Level 0.3 V

n. Set 3585B:

Instrument Preset
Stop Freq 20 kHz
Blue (shift) Cal Off⁽²⁾
Manual Entry 6.4 kHz⁽¹⁾
Res BW 300 Hz
Video BW 1 Hz
Counter On
(blue) Mkr Ofs→ Step
Range -15 dBm⁽³⁾
Blue (shift) Cal On⁽⁴⁾
Manual Entry 0 Hz
Manual Entry Step Up
Counter Off

o. Adjust the 339A until the marker amplitude reads -15 dBm.

p. Set 3585B:

Offset On
Enter Offset

q. Set 3585B:

Manual Entry Step Up

r. Read Marker amplitude this is the 2nd harmonic. Compare the value with the spec and record on Performance Test Card.

(1) From the test card.

(2) Save 4 for the 3583A.

(3) Use the up/down-arrow keys to change this parameter.

(4) Recall 4 for the 3585A.

s. Set 3585B:

Manual Entry Step Up

- t. Read Marker amplitude this is the 3rd harmonic. Compare value with spec and record on Performance Test Card.
- u. Repeat steps m through t for a frequency of 3.2 kHz. Record only the 3rd harmonic.

Low Frequency (1 MΩ)

- v. Connect the 339A to the 1 MΩ input of the 3585B via a 50Ω feedthru termination.
- w. Repeat steps m through u with the 3585B Input Impedance set for 1 MΩ. Record the results on the Performance Test Card.

Test Card – Harmonic Distortion

Frequency	Input			
	50Ω		1 MΩ	
	Harmonic		Harmonic	
	2nd	3rd	2nd	3rd
13.31 MHz				
20.01 MHz		XXX		XXX
6.4 kHz				
3.2 kHz	XXX		XXX	

Performance Tests
Return Loss

Return Loss

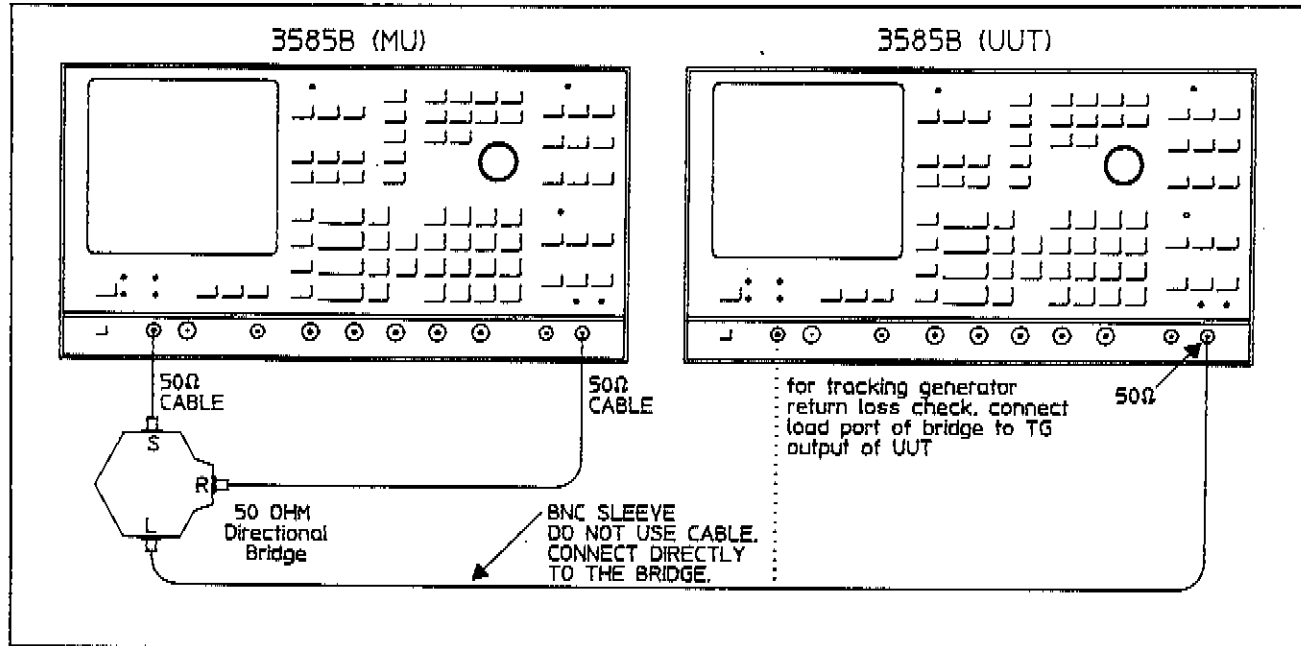

Figure 4-3.

This test verifies that the 3585B meets the Return Loss specification for the 50Ω and 75Ω inputs, and for the tracking generator output.

Specification: 50Ω/75Ω Input ≤ -26 dB; Tracking Gen ≤ -14 dB

Equipment: 3585B, 50Ω Directional Bridge (8271A), 75Ω Directional Bridge (Option 008), 50/75Ω Minimum Loss Pad, BNC sleeves (50Ω and 75Ω), 75Ω cables (qty 2), 50Ω cables (qty 2); length must be < 4 ft.)

Procedure: (UUT = Unit Under Test; MU = Measurement Unit)

- a. Connect the MU's 50Ω input to the reflected port of the 50Ω directional bridge. Connect the source port of the bridge to the tracking generator output of the MU. See Figure 4-3.
- b. Rotate the MU's tracking generator knob fully CCW (-11 dBm).
- c. Set MU:

```

Instrument Preset
Range . . . . . -10 dBm(1)
Start Frequency . . . . . 100 kHz
Store A→B
View B . . . . . Off
A-B . . . . . On
    
```

(1) Use the up/down-arrow keys to change this parameter.

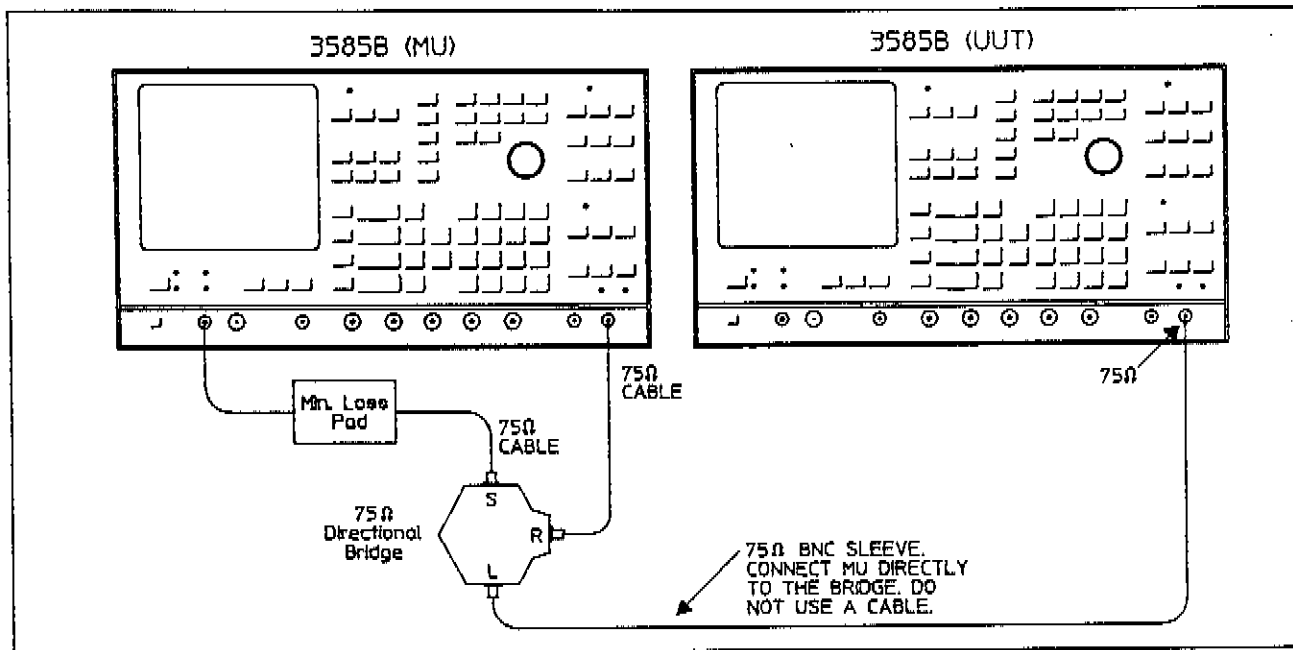

Figure 4-4.

d. Set UUT:

Instrument Preset
Manual Entry 0 Hz
Range -25 dBm⁽¹⁾

- e. Connect the load port of the bridge to the 50Ω input of the UUT using a 50Ω BNC sleeve.
- f. Using the MU, move the marker to the point of maximum amplitude. This is the return loss and it should be < -26 dB. Record the result on the Performance Test Card.
- g. Using the up arrow key, repeat step f for each of the UUT input ranges.
- h. Move the load port of the bridge from the 50Ω input to the tracking generator output of the UUT.
- i. The return loss should be < -14 dB. Record the result under "tracking generator" on the Performance Test Card.
- j. Disconnect the 50Ω bridge and connect the 75Ω bridge as shown in Figure 4-4.

(1) Use the up/down-arrow keys to change this parameter.

Performance Tests

Return Loss

k. Set MU:

Instrument Preset
Start Frequency 100 kHz
Input Impedance 75Ω
Range -10 dBm⁽¹⁾
Store A → B
View B Off
A-B On

- l. Connect the load port of the bridge to the 75Ω input of the UUT using a 75Ω BNC sleeve. Activate the 75Ω input of the UUT.
- m. Repeat step f for each of the UUT input ranges. Record the results under "75Ω input" on the Performance Test Card.

Test Card – Return Loss

Range	50Ω Input	75Ω Input	Tracking Gen
-25			
-20			XXXXXXXXXX
-15			XXXXXXXXXX
-10			XXXXXXXXXX
- 5			XXXXXXXXXX
0			XXXXXXXXXX
5			XXXXXXXXXX
10			XXXXXXXXXX
15			XXXXXXXXXX
20			XXXXXXXXXX
25			XXXXXXXXXX
30			XXXXXXXXXX

(1) Use the up/down-arrow keys to change this parameter.

IM Distortion (A)

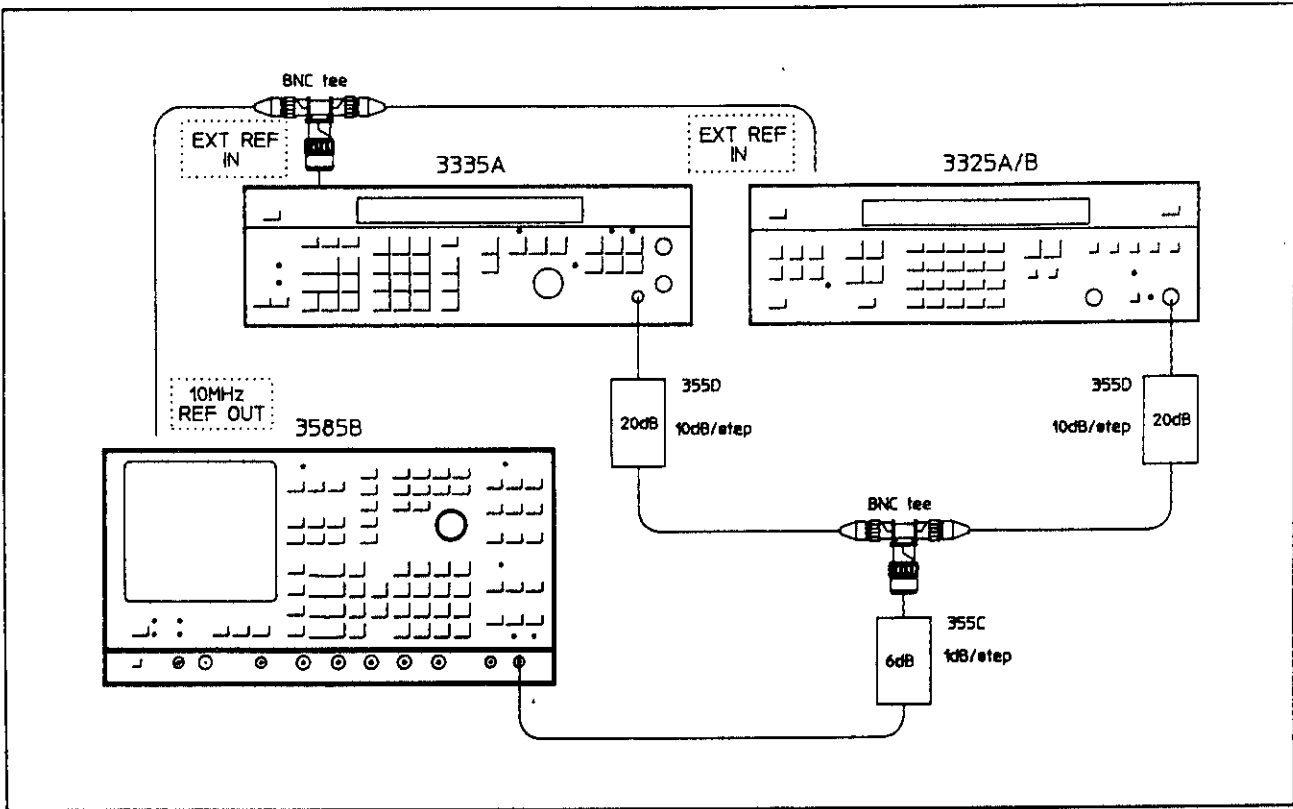

Figure 4-5.

Internally-generated second and third-order intermodulation distortion is measured with a two tone input whose difference frequency is varied from 106 Hz to 7.534 kHz.

Specification: < -80 dB below signal

Equipment: 3335A, 3325B, (2) 10 dB Step Attenuators(355D), 1 dB Step Attenuator(355C), BNC Tee.

Procedure:

- a. Connect equipment as shown in Figure 4-5. Set the attenuators connected to the sources to the 20 dB step. Set the attenuator connected to the 3585B to the 6 dB step.
- b. Set the 3585:

Instrument Preset	
Range	-20 dBm ⁽¹⁾
Res BW	3 Hz ⁽²⁾
Video BW	1 Hz
Blue (shift)	Cal Off ⁽³⁾

(1) Use the up/down-arrow keys to change this parameter.
 (2) Wait for the 3585 to calibrate (≈10 sec) before proceeding.
 (3) Save 4 for the 3585A.

Performance Tests

IM Distortion (A)

c. Set the 3325B:

Frequency 3.5 MHz
Amplitude 4 dBm

d. Set the 3585B:

Reference Level -20 dBm
Manual Entry 3.5 MHz

e. Adjust 3325B amplitude using modify keys until the 3585B amplitude is -26.0 dBm.

f. Set the 3335A:

Frequency (3.5 MHz + Δ Freq) Hz⁽¹⁾
Amplitude 4 dBm
Amplitude Incr 0.1 dBm

g. Set the 3585A:

Reference Level -20 dBm
Manual Entry (3.5 MHz + Δ Freq) Hz⁽¹⁾

h. Adjust 3335A amplitude using Incr key until 3585B amplitude is -26.0 dBm.

i. Set the 3585A:

Offset On
Enter Offset
Ref Level -50 dBm

j. Set the 3585B:

Manual Entry Δ Freq⁽¹⁾

k. Read 3585B amplitude. Record this value as the 2nd order IM.

l. Set the 3585B:

Manual Entry 3.5 MHz
CF Step Size Δ Freq⁽¹⁾
Manual Entry Step Down

m. Read the 3585B amplitude. Record this value as the 3rd order IM.

n. Set the 3585B: Offset Off

o. Repeat steps f through n for each Δ Freq.

(1) From the test card

Test Card—IM Distortion (A)

Δ Freq (Hz)	2 nd Order	3 rd Order
106		
377.8		
1024.5		
2778.4		
7534.9		

IM Distortion (B)

Internally-generated second and third-order intermodulation distortion is measured with a two-tone input whose difference frequency is fixed at 134.2 Hz.

Specification: < -80 dB below signal.

Equipment: 3335A, 3325B, (2) 10 dB Step Attenuators(355D), 1 dB Step Attenuator(355C), BNC Tee.

Procedure:

- a. Connect equipment as shown in Figure 4-5. Set the attenuators connected to the sources to the 20 dB step. Set the attenuator connected to the 3585B to the 6 dB step.
- b. Set the 3585B:

```

Instrument Preset
Range . . . . . -15 dBm(1)
Ref Level Trk . . . . . Off
Stop Freq . . . . . 40.1 MHz
Res BW . . . . . 3 Hz(2)
Video BW . . . . . 1 Hz
Blue (shift) . . . . . Cal Off(3)
    
```

- c. Set the 3335A:

```

Amplitude . . . . . 9 dBm
Amplitude Incr . . . . . 0.1 dBm
    
```

- d. Set the 3325B:

```

Amplitude . . . . . 9 dBm
    
```

(1) Use the up/down-arrow keys to change this parameter.
 (2) Wait for the 3585 to calibrate (\approx 10 sec) before proceeding.
 (3) Save 4 for the 3585A.

Performance Tests

IM Distortion (B)

- e. Set the 3335A:

Frequency Freq A⁽¹⁾

- f. Set the 3585B:

Manual Entry Freq A⁽¹⁾

- g. Adjust the 3335A amplitude using Incr key until 3585B amplitude is -21.0 dBm.

- h. Set the 3325B:

Frequency Freq B⁽¹⁾

- i. Set the 3585B:

Manual Entry Freq B⁽¹⁾

- j. Adjust the 3325B amplitude using modify keys until 3585B amplitude is -21.0 dBm.

- k. Set the 3585B:

Offset On
Enter Offset
Ref Level -50 dBm
Manual Entry 134.3 Hz

- l. Read the 3585B amplitude. Record A-B amplitude.

- m. Set the 3585B:

Manual Entry (2 B-A) Freq⁽¹⁾

- n. Read the 3585B amplitude. Record 2B-A amplitude.

- o. Set the 3585B:

Offset Off
Reference Level -15 dBm

- p. Repeat steps e through o for each A/B Freq combination on test card.

(1) From the test card.

Performance Tests
IM Distortion (B)

Test Card—IM Distortion (B)

3335 Freq A (Hz)	3325 Freq B (Hz)	A - B (Hz)	Reading	2B - A (Hz)	Reading
649.2	514.9	134.3		380.6	
998.9	864.6	134.3		730.3	
2995.4	2861.1	134.3		2726.8	
6492.2	6357.9	134.3		6223.6	
9989.0	9854.7	134.3		9720.4	

Performance Tests
Frequency Accuracy

Frequency Accuracy

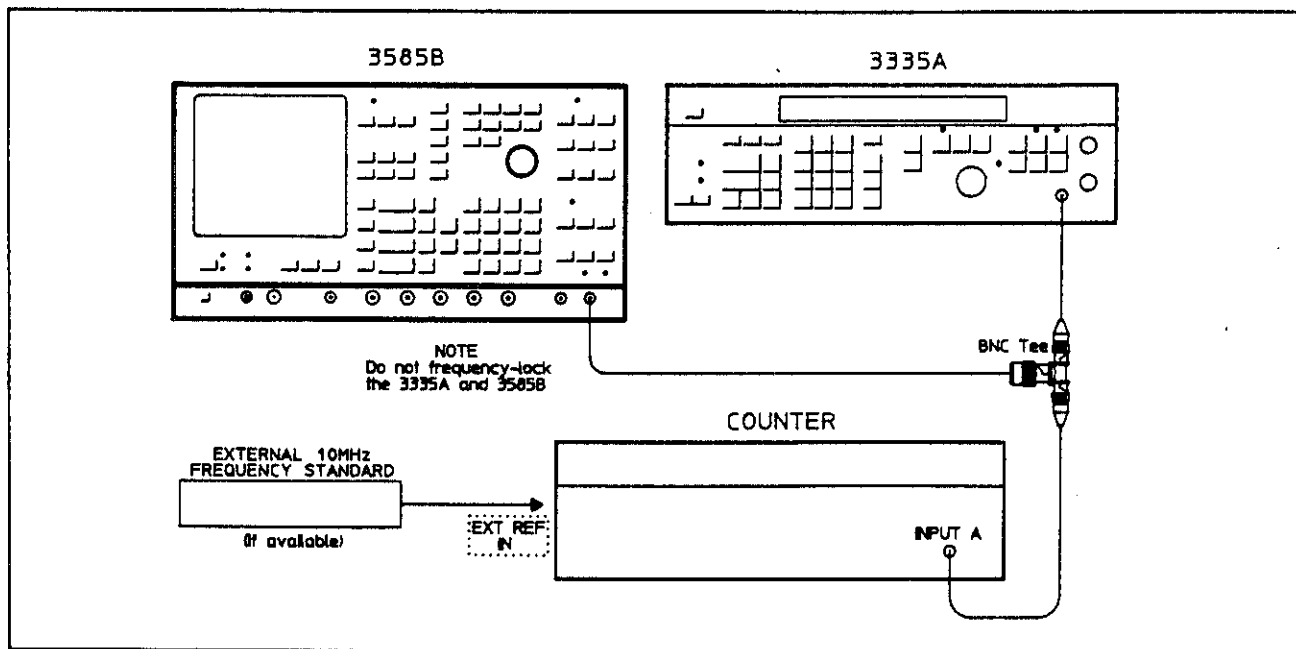

Figure 4-6.

This test verifies the frequency accuracy of the 3585B by using an external counter to check the internal frequency reference. It is important that the frequency counter used to perform this test has a reference which is more accurate than that of the 3585B.

Specification: Counter Accuracy $\pm 0.3 \text{ Hz} \pm 1 \times 10^{-7} / \text{month}$

Equipment: 3335A, 5328A

Procedure:

- a. Allow the instruments used in this test to warm up for 15 to 20 minutes before beginning the test.

- b. Set 3585B:

Instrument Preset	
Manual Entry	9 MHz
Counter	On

- c. Set 3335A:

Frequency	9 MHz
Amplitude	0 dBm

- d. Using a BNC "T" connector, connect 3335A 50Ω output to the frequency counter and the 3585B 50Ω input.

e. Set the 5328A:

Level A	Preset
Function	Freq A
Freq Res	0.1 Hz
Input50Ω
Atten	×1
Com A		

NOTE

Be sure that the 3335A and the 3585B are operating on their own internal references. Disconnect any reference connection common to both instruments. The counter can be locked to an external 10 MHz frequency standard, if it is available.

f. Record the frequency difference between the frequency counter and the 3585B counter reading. Difference frequency equals _____ Hz.

Performance Tests
Source Accuracy

Source Accuracy

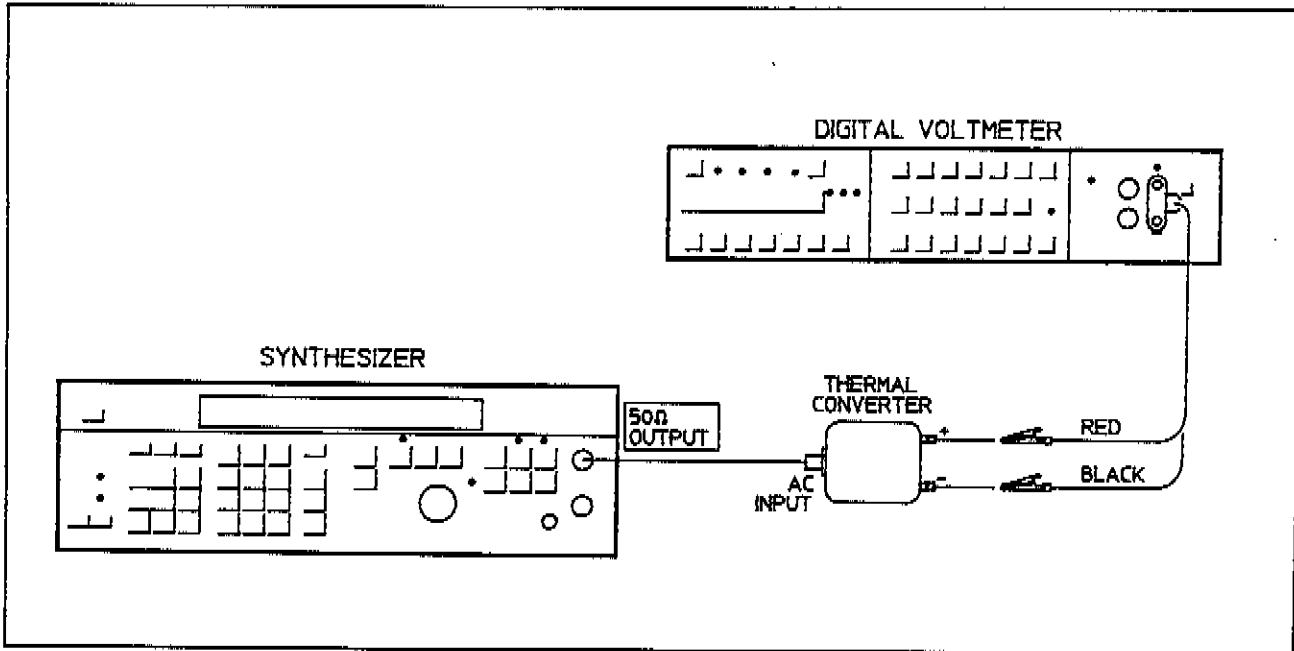

Figure 4-7.

This procedure calibrates the amplitude outputs of the 3335A and 3325B sources which are used to verify the amplitude accuracy of the 3585B. The standards of amplitude accuracy are the 3455A voltmeter and the thermal converter.

Equipment: 3335A, 3325B, 11048C (50Ω term.), BNC cable, 50Ω thermal converter (T.C.), 3455A voltmeter

Procedure:

- a. Connect the 3335A 50Ω output through the BNC cable to 50Ω termination (11048C), then through a banana plug to the voltmeter. Set the voltmeter to the ac mode.

- b. Set 3335A:

Frequency	1 kHz
Amplitude	6 dBm
Amplitude Incr	0.01 dBm

- c. Measure the AC volts. Adjust the 3335A amplitude using the Incr key until the ac level equals the 446.2 mV ± 0.3 mV.
- d. Remove the 50Ω termination and cable from the DVM. Connect the 50Ω thermal converter output to the DVM. Then connect the 3335A through the cable⁽¹⁾ to the thermal converter input. This sequence protects the thermal converter from damage. Set the voltmeter to the dc mode. (See Figure 4.7.)

- e. Allow the reading to settle for 1 minute. Read and record the T.C. output (≈ 5.7 mV_{dc})

(1) Be sure to use the same cable as used in step a.

- f. Set the 3335A for a Frequency listed on Performance Test Card.
- g. Adjust the 3335A amplitude until the DVM's dc level equals the recorded T.C. output voltage within ± 0.01 mV. Use the Incr keys after pressing Amplitude. Allow the reading to settle for 10 seconds.
- h. Record the calculated amplitude offset (3335A setting - 6.00) on the Test Card.
- i. Repeat steps f through h until all 3335A frequencies have been calibrated.
- j. Disconnect 3335A from T.C. and the T.C. from the DVM.
- k. Repeat steps a through k using the 3325B instead of the 3335A until all 3325B frequencies have been calibrated.

NOTE

The cable is part of the calibration and must be used during the Range Calibration Check, Reference Level Check, and Flatness Checks.

Test Card—Source Accuracy

T.C. Output _____ mV_{dc}

3335A Frequency	Amplitude Offset
100 kHz	
150 kHz	
1.1 MHz	
5.1 MHz	
9.53 MHz	
10.1 MHz	
15.1 MHz	
20.1 MHz	
25.1 MHz	
30.1 MHz	
35.1 MHz	
40.1 MHz	

T.C. Output _____ mV_{dc}

3325B Frequency	Amplitude Offset
20 Hz	
2 kHz	
20 kHz	
50 kHz	
150 kHz	

Performance Tests

50Ω Flatness

50Ω Flatness

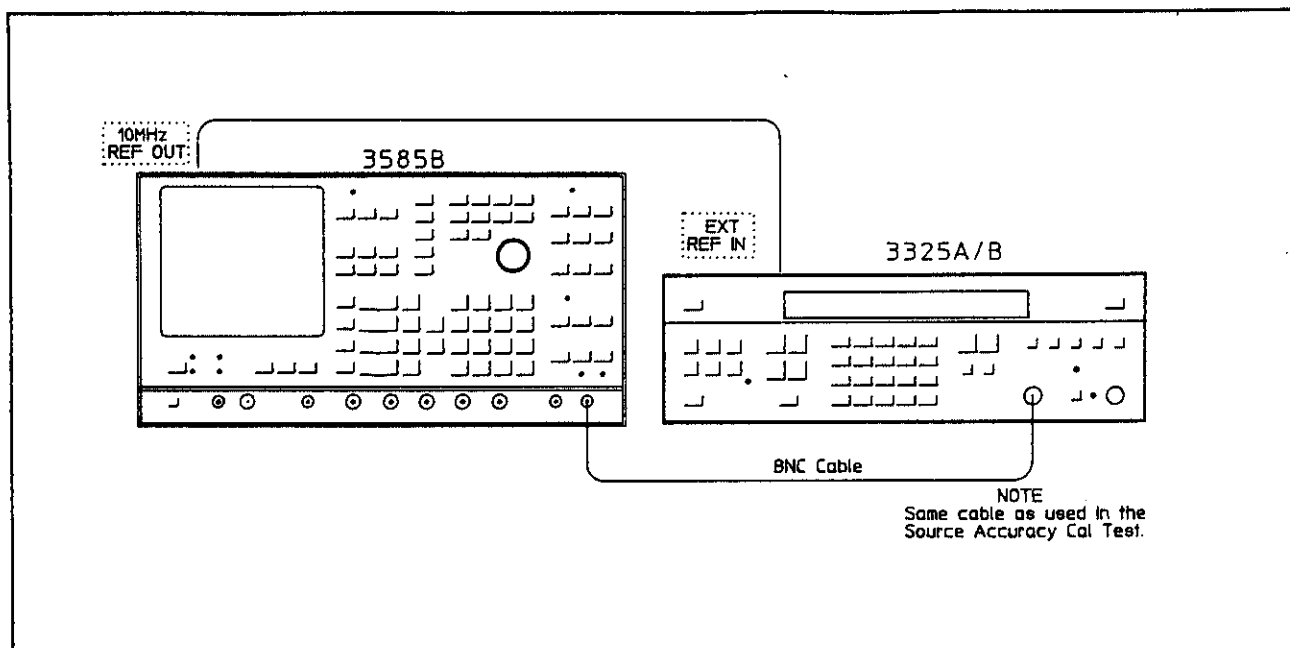

Figure 4-8a.

The amplitude frequency response of the 50Ω input is verified from 20 Hz to 40.1 MHz.

Specification: ±.5 dB

Equipment: 3325B, 3335A, Calibration cable, Calibration data from Source Accuracy test.

Procedure:

20 Hz to 150 kHz

- Connect the 3325B output to the 3585B 50Ω input using the same cable used as in the source accuracy performance tests. See Figure 4-8a.
- Set 3325B:

Function Sine
Offset0 V

c. Set the 3585B for:

```

Instrument Preset
Auto Range . . . . . Off(1)
Range . . . . . -25 dBm(1)
Reference Level . . . . . -22 dBm
Start Frequency . . . . . 0 Hz
Stop Frequency . . . . . 40.1 MHz
dB/Div . . . . . 1 dB
Res BW . . . . . 3 Hz(2)
Reference Level Track . . . . . Off
Blue (shift) . . . . . Cal Off(3)
Input Impedance . . . . . 50Ω
Save . . . . . 1
    
```

d. Set 3325B:

```

Frequency . . . . . (4)
Amplitude . . . -25 dBm + source cal offset(5)
    
```

e. Set 3585B:

```

Manual Entry . . . . . (4)
    
```

f. Read and record the marker amplitude.

g. Repeat steps d through f for each Freq on Performance Test Card.

h. Take the difference between the largest and smallest marker amplitude readings. This value should be $\leq .5$ dB. Record this value as "dB Band" on the Performance Test Card.

Test Card – 50Ω Flatness (20 Hz to 150 kHz)

Frequency	Marker Amplitude
20 Hz	
2 kHz	
20 kHz	
50 kHz	
150 kHz	
dB Band	

- (1) Use the up/down-arrow keys to change this parameter.
- (2) Wait for the 3585 to calibrate (≈ 10 sec) before proceeding.
- (3) Save 4 for the 3585A.
- (4) From the test card.
- (5) Source cal offset for the current frequency from the Source Calibration Accuracy test.

Performance Tests
50Ω Flatness

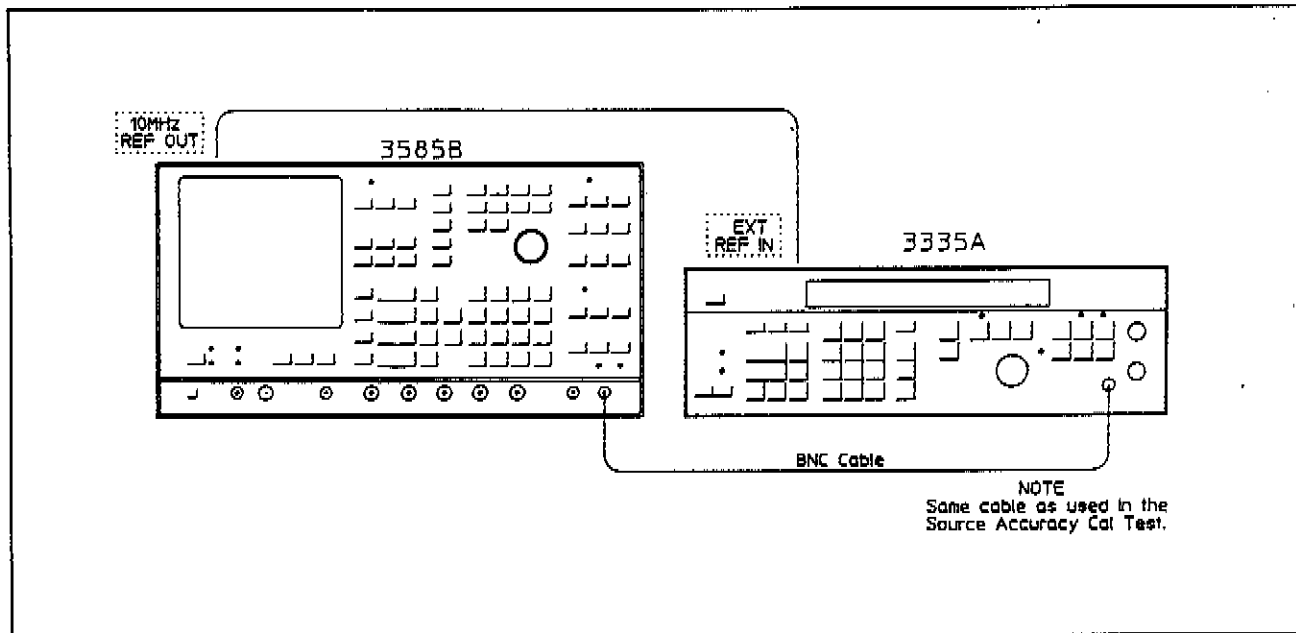

Figure 4-8b.

100kHz to 40.1 MHz

- i. Connect the 3335A output to the 3585B 50Ω input as shown in Figure 4-8b.
- j. Set the 3585B:

Recall	1
Res BW	10 Hz
Blue (shift)	Cal On ⁽¹⁾
Blue (shift)	Cal Off ⁽²⁾

- k. Set the 3335A:

Frequency	(3)
Amplitude	-25 dBm + Source Cal Offset ⁽⁴⁾

- l. Set the 3585B:

Manual Entry	Freq from Test Card
Range	-25 dBm ⁽⁵⁾

- m. Set the 3585B for each Range on the Test Card. Record the marker amplitude.
- n. Repeat steps k, l, and m for each Frequency on the Performance Test Card.

(1) Save 4 for the 3585A.
 (2) Recall 4 for the 3585A.
 (3) From the test card.
 (4) Source Cal Offset for current freq from Source Cal Accuracy Test
 (5) Use the up/down-arrow keys to change this parameter.

- o. For each range, find the largest and smallest amplitude and record their difference as the "dB Band." This value should be $\leq .5$ dB.

Test Card—50Ω Flatness (100 kHz to 40.1 MHz)

Range	Frequency (MHz)										dB Band
	.1	1.1	5.1	10.1	15.1	20.1	25.1	30.1	35.1	40.1	
-25											
-20											
-15											
-10											
-5											
0											
5											
10											
15											
20											
25											
30											

Range Calibration

This test verifies the amplitude accuracy of the attenuators of the 50Ω and 75Ω inputs..

Specification: $\pm .4$ dB

Equipment: 3335A, Source Accuracy Data @150 kHz

Procedure:

- a. Connect 3335A 50Ω output to 3585B 50Ω input.
- b. Set 3335A:

Frequency 150 kHz
 Amplitude . . -45 dBm + Source Cal Offset⁽¹⁾
 Amplitude Incr 5 dBm

- c. Set 3585B:

Instrument Preset
 Manual Entry 150 kHz
 Reference Level -44.5 dBm
 dB/Div 1 dB
 Res BW 30 kHz

(1) Source Cal Offset for current freq from Source Cal Accuracy Test

Performance Tests

Range Calibration

- d. Read the 3585B marker amplitude and record the difference between the marker value and the 3335A amplitude (excluding source cal offset) on the Performance Test Card.

Example: 3585 amplitude – 3335A amplitude (excluding source cal offset)

- e. Set 3585B:

Range Up⁽¹⁾

- f. Set 3335A:

Incr Up

- g. Read the 3585B Marker amplitude and record the difference between the 3335A amplitude (excluding source cal offset) and the Marker value on the Performance Test Card.

- h. Repeat steps e through g until each Range on the Performance Test Card has been compared to spec and recorded.

- i. Set the 3335A:

Amplitude . . . -45 dBm + Source Cal Offset⁽²⁾

- j. Set the 3585B:

Range -25 dBm⁽¹⁾
Res BW ⁽³⁾

- k. Repeat steps d through j for each Res BW on the Performance Test Card.

Test Card – Range Calibration

Res BW	Range											
	-25	-20	-15	-10	-5	0	5	10	15	20	25	30
30 kHz												
10 kHz												
3 kHz												
1 kHz												
300 Hz												
100 Hz												
30 Hz												
10 Hz												
3 Hz												

(1) Use the up/down-arrow keys to change this parameter.
 (2) Source Cal Offset for current freq from Source Cal Accuracy Test
 (3) From the test card.

Amplitude Linearity

This test verifies the accuracy of the log-conversion circuitry.

- Specification:**
- 0 dB to -20 dB: ±0.3 dB
 - 20 dB to -50 dB: ±0.6 dB
 - 50 dB to -80 dB: ±1.0 dB
 - 80 dB to -95 dB: ±2.0 dB

Equipment: 3335A

Procedure:

- a. Connect 3335A 50Ω output to 3585B 50Ω input.
- b. Set 3585B:

```

Instrument Preset
Manual Entry . . . . . 1 MHz
Res BW . . . . . 3 Hz
Video BW . . . . . 1 Hz
Range . . . . . 10 dBm(1)

```

- c. Set 3335A:

```

Frequency . . . . . 1 MHz
Amplitude . . . . . 10 dBm
Amplitude Incr . . . . . 0.1 dBm

```

- d. Adjust 3335A amplitude using the INCR key until 3585B Marker reads 10.0 dBm.

- e. Set 3585B:

```

Offset . . . . . On
Enter Offset

```

- f. Set 3335A:

```

Amplitude Incr . . . . . .10 dBm

```

- g. Set 3335A:

```

Incr . . . . . Down

```

- h. Read 3585B Marker amplitude compare with spec and record on Performance Test Card.

- i. Repeat steps g through h for each 3335A approx amplitude on Performance Test Card.

(1) Use the up/down-arrow keys to change this parameter.

Performance Tests

Reference Level Accuracy

Test Card—Amplitude Linearity

Approx 3335A Setting (dBm)	Ideal 3585B Reading (dBm)	3585B Reading (dBm)
10	00.00	00.00
0	-10.00	
-10	-20.00	
-20	-30.00	
-30	-40.00	
-40	-50.00	
-50	-60.00	
-60	-70.00	
-70	-80.00	
-80	-90.00	

Reference Level Accuracy

This test verifies that the 3585B meets the specification for Reference Level Accuracy.

Specification: +10 dB to -50 dB: ± 0.4 dB
-50 dB to -70 dB: ± 0.7 dB
-70 dB to -90 dB: ± 1.5 dB

Equipment: 3335A

Procedure:

- a. Connect 3335A 50 Ω output to the 3585B's 50 Ω input.
- b. Set 3335A:

Frequency 9.53 MHz
Amplitude . . 10.0 dBm + Source Cal Offset⁽¹⁾
Amplitude Incr 10 dBm

(1) Source Cal Offset for current freq from Source Cal Accuracy Test

c. Set 3585B:

Instrument Preset
Range 0 dBm⁽¹⁾
Reference Level 10 dBm
Ref Level Track Off
dB/Div 2 dB
Res BW 30 kHz⁽²⁾
Video BW 1 Hz
Manual Entry 9.53 MHz

d. Read the 3585B marker amplitude. Record the difference between the marker value and the 3335A Amplitude setting (excluding the source cal. offset) on the Performance Test Card under Ref Level 10 dBm and the current Res BW.

Example: 3585B amplitude - 3335A amplitude (excluding source cal offset)

e. Using the 3335A Incr key, decrement the 3335A amplitude 10 dBm, then set the 3585B Ref Level to the next listed Ref level on the Performance Test Card.

f. Read the 3585B marker amplitude. Record the difference between the marker value and the 3335A Amplitude setting (excluding the source cal. offset) on the Performance Test Card under the current Ref Level.

g. Repeat steps e through f for each Ref Level on the Test Card through Ref Level -60.0 dBm. For Ref Levels of -50 dBm and -60 dBm, set the 3585B's dB/Div to 5 dB.

h. Set the 3585B:

Range 20 dBm⁽¹⁾
dB/Div 10 dB

i. Set the 3335A:

Amplitude . . -50 dBm + Source Cal Offset⁽³⁾

j. Set the 3585B:

Ref Level -50 dBm

k. Read the 3585B marker amplitude. Record the difference between the marker value and the 3335A Amplitude setting (excluding the source cal. offset) on the Performance Test Card under Ref Level -70 dBm and the current Res BW.

l. For each Ref Level below -70 dB listed for the current Res BW on the Performance Test Card decrement the 3335A Amplitude by 10 dBm using the Incr key. Then decrement the 3585B Ref Level by 10 dBm.

(1) Use the up/down-arrow keys to change this parameter.

(2) From the test card.

(3) Source Cal Offset for the current frequency from the Source Cal Accuracy Test

Performance Tests

Reference Level Accuracy

- m. Read the 3585B marker amplitude. Record the difference between the marker value and the 3335A Amplitude setting on the Performance Test Card under the current Ref Level. This will be (3585B Ref Level - 3585B Range).
- n. Repeat steps c through m for each Res BW listed on the Performance Test Card.

Test Card—Reference Level Accuracy

Res BW	3585B Reference Level										
	10	0	-10	-20	-30	-40	-50	-60	-70	-80	-90
30 kHz										XXXX	XXXX
10 kHz											XXXX
3 kHz											XXXX
1 kHz											
300 Hz											
100 Hz											
30 Hz											
10 Hz											
3 Hz											

Noise Vs Bandwidth

Specification: See "Test Limits" under Noise vs Bandwidth in the Performance Tests.

Res BW	Manual Entry			
	39 MHz		10×Res BW or 10 kHz	
	Ref Level		Freq (kHz)	Ref Level
	-60 dBm	-45 dBm		-60 dBm
30. kHz			300	
10. kHz			100.	
3. kHz			30.	
1. kHz			10.	
300. Hz			10.	
100. Hz			10.	
30. Hz			10.	
10. Hz			10.	
3. Hz			10.	

Noise Lvl (1Hz) at 40 Hz = _____

Tracking Generator Frequency Accuracy

Specification: ± 1 Hz relative to analyzer tuning

Res BW	(10 MHz - f ₂)
30. kHz	
10. kHz	
3. kHz	
1. kHz	
300. Hz	
100 .Hz	
30. Hz	
10. Hz	
3 .Hz	

Residual Spurs

Specification: ≤ -120 dBm

Spur Freqs (Hz)	3585B Reading
29,475,000	
14,737,500	
35,943,750	
33,356,250	
800,000	
22,263,158	
28,089,474	
27,000,000	
29,632,500	
35,167,500	

Performance Test Card

Low Frequency Responses

Specification: -120 dBm

Description	Freq	Harmonics												
		1	2	3	4	5	6	7	8	9	10			
Line Freq	60 Hz													
A/D Clock	5 kHz													
Frac/N Clock	100 kHz													
Step Loop Clock	1 MHz													
Internal Ref	10 MHz					XXX	XXX	XXX	XXX	XXX	XXX	XXX	XXX	XXX
Power Supply														
CRT Oscillator														

Zero Response

Specification: LO Feedthrough < -15 dB Below Range

3585B Reading = _____ dB

Test Card-Tracking Generator Flatness

Specification: Tracking Generator Response ± 0.7 dB Pass/Fail (circle one)

1 M Ω Input Noise

Specification: -74 & -86 dB below Range @ 10 kHz and 500 kHz respectively.

Freq	Range												
	-25	-20	-15	-10	-5	0	5	10	15	20	25	30	
10 kHz													
500 kHz													

1 M Ω Input Check

Specification: < 1 dB amplitude offset from the -10 dB Range.

Range	Amplitude Offset
-5	
0	
5	
10	
15	

1 M Ω Flatness

Specification: 20 Hz to 10 MHz = ± 7 dB

10 MHz to 40.1 MHz = ± 1.5 dB

Frequency	Max Deviation	
	Range = -5 dBm	Range = +15 dBm
20 Hz \rightarrow 1 kHz		
1 kHz \rightarrow 100 kHz		
100 kHz \rightarrow 10 MHz		
10 MHz \rightarrow 40.1 MHz		

Test Card-Bandwidth Accuracy

Specification: 3 dB Bandwidth: $\pm 20\%$ of BW setting at the 3 dB points

Selectivity (Shape Factor): $< 11:1$

Res Bw	3 dB Bandwidth				60 dB bandwidth			Shape Factor
	Freq Span	Sweep Time	BW Meas.	Test Limit	Freq Span	Sweep Time	BW Meas.	
3 Hz	10 Hz	15		3 Hz ± 6 Hz	100 Hz	23		
10 Hz	30 Hz	8		10 Hz ± 2 Hz	200 Hz	15		
30 Hz	100 Hz	7		30 Hz ± 6 Hz	500 Hz	10		
100 Hz	200 Hz	6		100 Hz ± 20 Hz	2 kHz	8		
300 Hz	1 kHz	6		300 Hz ± 60 Hz	5 kHz	5		
1 kHz	2 kHz	6		1 kHz ± 200 Hz	20 kHz	5		
3 kHz	10 kHz	6		3 kHz ± 600 Hz	50 kHz	5		
10 kHz	20 kHz	6		10 kHz ± 3 kHz	100 kHz	5		
30 kHz	100 kHz	6		30 kHz ± 6 kHz	500 kHz	5		

Image 90/10 MHz Spurious

Specification: < -80 dB below signal

3335A freq (MHz)	3585B Spur Freq (MHz)	Spur Level
30.75	10.05	
40.05	39.35	
20.05	10.05	
30.05	10.05	
20.75	10.05	
30.05	40.05	

Second-Order IM Distortion

Specification: < -80 dB below signal

Input Freq	3585B Reading
175 kHz	
5.175 MHz	

IF Harmonic Distortion

Specification: < -80 dB below signal

Order	3585B Reading
2nd	
3rd	

Performance Test Card

Conversion/Input Spurs

Specification: -80dB below signal

Source Frequency (Hz)	Tune Frequency (Hz)	3585B Reading
34,750,000	34,550,000	
12,250,000	12,116,666	
19,750,000	19,600,000	
34,750,000	34,683,333	
19,750,000	19,675,000	
12,250,000	12,170,000	
19,750,000	19,630,000	
34,750,000	34,670,000	
15,464,286	15,347,619	
25,750,000	25,666,666	

Marker Accuracy

Specification: $\pm 0.2\%$ of Frequency Span \pm RBW

3335A Freq (MHz)	3585B Marker Freq
20.00	

Cal Offset

Specification:

Res BW	Freq. Span	Freq. Test Limit	Ampl. Test Limit
30 kHz	50 kHz	± 3.5 kHz	± 5.0 dB
10 kHz	20 kHz	± 3.5 kHz	± 5.0 dB
3 kHz	5 kHz	± 3.5 kHz	± 5.0 dB
1 kHz	2 kHz	± 3.0 kHz	± 5.0 dB
300 Hz	500 Hz	± 900 Hz	± 5.0 dB
100 Hz	200 Hz	± 300 Hz	± 5.0 dB
30 Hz	50 Hz	± 90 Hz	± 5.0 dB
10 Hz	20 Hz	± 30 Hz	± 5.0 dB
3 Hz	7 Hz	± 15 Hz	± 5.0 dB

Res BW	Freq. Span	Sweep Time	Internal Offset Freq.	Internal Offset Ampl.
30 kHz	50 kHz	0.2 sec		
10 kHz	20 kHz	0.2 sec		
3 kHz	5 kHz	0.2 sec		
1 kHz	2 kHz	0.2 sec		
300 Hz	500 Hz	1.6 sec		
100 Hz	200 Hz	3.2 sec		
30 Hz	50 Hz	5.0 sec		
10 Hz	20 Hz	15 sec		
3 Hz	7 Hz	20 sec		

Compression

Specification: dB Band \leq .5 dB

3335A (dBm)	Res BW = 300 Hz		Res BW = 3 Hz	
	3585B Marker	3335A-3585B	3585B Marker	3335A-3585B
12.3				
11.3				
10.3				
9.3				
8.3				
7.3				
6.3				
5.3				
4.3				
3.3				
2.3				
1.3				
0.3				
-0.7				
-1.7				
-2.7				
-3.7				
-4.7				
-5.7				
-6.7				

Res BW = 300 Hz

Res BW = 3 Hz

dB Band = _____

dB Band = _____

API Spurs

Specification: -80 dB below signal

Spur Freq (MHz)	Offset Freq (kHz)	3585B Reading
0.4001	2.0	
0.40019	3.8	
9.4001	2.0	
9.40019	3.8	
18.4001	2.0	
18.40019	3.8	
27.4001	2.0	
27.40019	3.8	
36.4001	2.0	
36.40019	3.8	

Performance Test Card

Step IF Fractional-N Spur

Specification: -80 dB below signal

Spur Freq (Hz)	3585B Reading
3,450,500	
8,050,500	
11,650,500	
16,050,500	
20,450,500	
27,450,500	
31,650,500	
35,850,500	
40,050,500	

Local Oscillator Sidebands

Specification: < -80 dB below signal

Power Supply _____ Hz CRT Oscillator _____ Hz

Source frequency = 10 MHz:	Frequency	Sideband Harmonics									
		-5	-4	-3	-2	-1	1	2	3	4	5
	50/60 Hz										
	5 kHz										
	100 kHz										
	1 MHz										
	Power Supply										
	CRT Oscillator										
Source frequency = 39 MHz:	Frequency	Sideband Harmonics									
		-5	-4	-3	-2	-1	1	2	3	4	5
	50/60 Hz										
	5 kHz										
	100 kHz										
	1 MHz										
	Power Supply										
	CRT Oscillator										

Harmonic Distortion

Specification: < -80 dB below signal (-70 dB for 1 M Ω input)

Frequency	Input			
	50 Ω		1 M Ω	
	Harmonic		Harmonic	
	2nd	3rd	2nd	3rd
13.31 MHz				
20.01 MHz		XXX		XXX
6.4 kHz				
3.2 kHz	XXX		XXX	

Return Loss

Specification: 50Ω/75Ω Input ≤ -26 dB; Tracking Gen ≤ -14 dB

Range	50Ω Input	75Ω Input	Tracking Gen.
-25			
-20			XXXXXXXXXX
-15			XXXXXXXXXX
-10			XXXXXXXXXX
-5			XXXXXXXXXX
0			XXXXXXXXXX
5			XXXXXXXXXX
10			XXXXXXXXXX
15			XXXXXXXXXX
20			XXXXXXXXXX
25			XXXXXXXXXX
30			XXXXXXXXXX

IM Distortion (A)

Specification: < -80 dB below signal

ΔFreq (Hz)	2 nd Order	3 rd Order
106		
377.8		
1024.5		
2778.4		
7534.9		

IM Distortion (B)

Specification: -80 dB below signal

3335 Freq A (Hz)	3325 Freq B (Hz)	A - B (Hz)	Reading	2B - A (Hz)	Reading
649.2	514.9	134.3		380.6	
998.9	864.6	134.3		730.3	
2995.4	2861.1	134.3		2726.8	
6492.2	6357.9	134.3		6223.6	
9989.0	9854.7	134.3		9720.4	

Frequency Accuracy

Specification: Counter Accuracy ±0.3 Hz ±1×10⁻⁷/month

Difference frequency equals _____ Hz.

Performance Test Card

Source Accuracy

T.C. Output _____ mV_{dc}

3335A Frequency	Amplitude Offset
100 kHz	
150 kHz	
1.1 MHz	
5.1 MHz	
9.53 MHz	
10.1 MHz	
15.1 MHz	
20.1 MHz	
25.1 MHz	
30.1 MHz	
35.1 MHz	
40.1 MHz	

T.C. Output _____ mV_{dc}

3325B Frequency	Amplitude Offset
20 Hz	
2 kHz	
20 kHz	
50 kHz	
150 kHz	

50Ω Flatness

Specification: ±.5 dB
(20 Hz to 150 kHz)

Frequency	Marker Amplitude
20 Hz	
2 kHz	
20 kHz	
50 kHz	
150 kHz	
dB Band	

(100 kHz to 40.1 MHz)

Range	Frequency (MHz)										dB Band
	.1	1.1	5.1	10.1	15.1	20.1	25.1	30.1	35.1	40.1	
-25											
-20											
-15											
-10											
-5											
0											
5											
10											
15											
20											
25											
30											

Range Calibration

Specification: ± 4 dB

Res BW	Range												
	-25	-20	-15	-10	-5	0	5	10	15	20	25	30	
30 kHz													
10 kHz													
3 kHz													
1 kHz													
300 Hz													
100 Hz													
30 Hz													
10 Hz													
3 Hz													

Amplitude Linearity

Specification: 0 dB to -20 dB: ± 0.3 dB
 -20 dB to -50 dB: ± 0.6 dB
 -50 dB to -80 dB: ± 1.0 dB
 -80 dB to -95 dB: ± 2.0 dB

Approx 3335A Setting (dBm)	Ideal 3585B Reading (dBm)	3585B Reading (dBm)
10	00.00	00.00
0	-10.00	
-10	-20.00	
-20	-30.00	
-30	-40.00	
-40	-50.00	
-50	-60.00	
-60	-70.00	
-70	-80.00	
-80	-90.00	

Performance Test Card

Reference Level Accuracy

Specification: +10 dB to -50 dB: ± 0.4 dB

-50 dB to -70 dB: ± 0.7 dB

-70 dB to -90 dB: ± 1.5 dB

Res BW	3585B Reference Level										
	10	0	-10	-20	-30	-40	-50	-60	-70	-80	-90
30 kHz										XXX	XXX
10 kHz											XXX
3 kHz											XXX
1 kHz											
300 Hz											
100 Hz											
30 Hz											
10 Hz											
3 Hz											